



**HAL**  
open science

## Determinants of bacterial survival and proliferation in blood

Pierre Lê-Bury, Hebert Echenique-Rivera, Javier Pizarro-Cerdá, Olivier Dussurget

► **To cite this version:**

Pierre Lê-Bury, Hebert Echenique-Rivera, Javier Pizarro-Cerdá, Olivier Dussurget. Determinants of bacterial survival and proliferation in blood. FEMS Microbiology Reviews, In press, pp.fuae013. 10.1093/femsre/fuae013 . pasteur-04585268

**HAL Id: pasteur-04585268**

**<https://pasteur.hal.science/pasteur-04585268>**

Submitted on 23 May 2024

**HAL** is a multi-disciplinary open access archive for the deposit and dissemination of scientific research documents, whether they are published or not. The documents may come from teaching and research institutions in France or abroad, or from public or private research centers.

L'archive ouverte pluridisciplinaire **HAL**, est destinée au dépôt et à la diffusion de documents scientifiques de niveau recherche, publiés ou non, émanant des établissements d'enseignement et de recherche français ou étrangers, des laboratoires publics ou privés.



Distributed under a Creative Commons Attribution - NonCommercial - NoDerivatives 4.0 International License

# Review article

## Determinants of bacterial survival and proliferation in blood

### Authors

Pierre Lê-Bury<sup>1,2</sup>, Hebert Echenique-Rivera<sup>1</sup>, Javier Pizarro-Cerdá<sup>1,3</sup>, Dussurget Olivier<sup>1,\*</sup>

### Affiliations

<sup>1</sup>Institut Pasteur, Université Paris Cité, CNRS UMR6047, *Yersinia* Research Unit, F-75015 Paris, France

<sup>2</sup>Université Paris-Saclay, Inserm, CEA, Center for Immunology of Viral, Autoimmune, Hematological and Bacterial Diseases (ImVA-HB/IDMIT/UMR1184), Fontenay-aux-Roses, France

<sup>3</sup>Institut Pasteur, Université Paris Cité, *Yersinia* National Reference Laboratory, WHO Collaborating Research & Reference Centre for Plague FRA-140, Paris, France

### \*Corresponding author

Institut Pasteur, Université Paris Cité, CNRS UMR6047, *Yersinia* Research Unit, F-75015 Paris, France. E-mail: olivier.dussurget@pasteur.fr

### One sentence summary

This review provides an overview of the key factors evolved by bacteria to subvert immune defenses triggered by bloodstream infection, highlighting a combination of specific and universal molecular mechanisms that could be targeted by future therapies.

24 **Abstract**

25 Bloodstream infection is a major public health concern associated with high mortality and high  
26 healthcare costs worldwide. Bacteremia can trigger fatal sepsis whose prevention, diagnosis  
27 and management have been recognized as a global health priority by the World Health  
28 Organization. Additionally, infection control is increasingly threatened by antimicrobial  
29 resistance, which is the focus of global action plans in the framework of a One Health response.  
30 In-depth knowledge of the infection process is needed to develop efficient preventive and  
31 therapeutic measures. The pathogenesis of bloodstream infection is a dynamic process  
32 resulting from the invasion of the vascular system by bacteria, which finely regulate their  
33 metabolic pathways and virulence factors to overcome the blood immune defenses and  
34 proliferate. In this review, we highlight our current understanding of determinants of bacterial  
35 survival and proliferation in the bloodstream and discuss their interactions with the molecular  
36 and cellular components of blood.

37  
38 **Keywords**

39 Bloodstream infection; bacteremia; bacterial pathogenesis; virulence factors; immune  
40 subversion

ORIGINAL UNEDITED MANUSCRIPT

## 41 Introduction

42 Bacteremia is the presence of viable bacteria in the bloodstream. It sometimes results  
43 from activities such as toothbrushing, dental extraction or other minor medical procedures,  
44 which generally lead to transient and asymptomatic colonization of the blood before bacterial  
45 elimination by the immune system (Lockhart *et al.* 2008). On the other hand, it can constitute  
46 a *bona fide* step of bacterial pathogenesis. Bacteria can enter the bloodstream directly from  
47 a breach in the vascular system upon catheterization, surgery, intravenous drug injection,  
48 arthropod bite, animal bite and scratches, or injuries such as accidents, falls and cuts. Blood  
49 can also be colonized as a complication of a primary infection site, *e.g.*, following pneumonia,  
50 meningitis, peritonitis, or skin, soft tissue, bone, joints, biliary or urinary tract infections.  
51 Bacteria can then colonize other organs by hematogenous spread, triggering secondary  
52 infections such as infectious endocarditis or osteomyelitis. Uncontrolled bloodstream  
53 infections can ultimately lead to sepsis, septic shock and death (Hotchkiss *et al.* 2016).

54 Bloodstream infection is a major public health issue worldwide. Sepsis is estimated to  
55 affect 31.5 million individuals leading to 5.3 million deaths annually, and its control has been  
56 declared a health priority by the WHO (Fleischmann *et al.* 2016; Hotchkiss *et al.* 2016;  
57 Reinhart *et al.* 2017). The incidence rate of bloodstream infections has been estimated to  
58 range from 113 to 204 per 100,000 person-years in North America and Europe (Goto and Al-  
59 Hasan 2013). In the same population, short-term fatality rates and mortality rates were 13-  
60 20% and 20-37% per 100,000 person-years, respectively (Goto and Al-Hasan 2013). The  
61 bacteria the most frequently isolated from blood are *Staphylococcus aureus* and *Escherichia*  
62 *coli*. A worldwide sentinel study from 1997 to 2016 highlights inverse frequency trends with  
63 *S. aureus* decreasing from 22 to 18%, while *E. coli* rising from 18 to 24% (Diekema *et al.*  
64 2019). Urinary tract infection is the leading source of *E. coli* bloodstream infection. A recent  
65 systematic review of the literature indicates an estimated incidence rate of *E. coli* bacteremia  
66 reaching 48 per 100,000 person-years in high-income countries (Bonten *et al.* 2021). This  
67 rate increases over 100 in 55- to 75-year-olds and over 300 in 75- to 85-year-olds. The

68 average estimated fatality rate of *E. coli* bacteremia is 12% (Bonten *et al.* 2021). Skin infection  
69 is the most common cause of *S. aureus* bloodstream infection, which is associated with high  
70 morbidity and mortality (Barnett *et al.* 2013; Stewardson *et al.* 2016). Far less frequent  
71 bacteria responsible for bloodstream infections are *Klebsiella pneumoniae*, *Pseudomonas*  
72 *aeruginosa*, *Enterococcus faecalis*, *Staphylococcus epidermidis*, *Enterobacter cloacae*,  
73 *Streptococcus pneumoniae*, *Enterococcus faecium* and *Acinetobacter baumannii*,  
74 representing 2 to 7% (Diekema *et al.* 2019). In low-resource regions, *Salmonella enterica* is  
75 a major cause of bloodstream infections (Reddy, Shaw and Crump 2010; Deen *et al.* 2012).

76 Bloodstream infections are associated with high mortality, long hospital stays and high  
77 healthcare costs, especially those acquired by critically ill patients in intensive care units  
78 (Naber 2009; Brunelli *et al.* 2016; Wang *et al.* 2020). The emergence and spread of multidrug-  
79 resistant clones are additional concerns that limit therapeutic options and increase the  
80 economic burden of bacteremia management. The prevalence of antibiotic-resistant  
81 enterobacteria isolated from bloodstream infections has more than doubled in 20 years,  
82 reaching 15,8% in 2016 (Diekema *et al.* 2019). In contrast, global prevalence of oxacilline-  
83 resistant *S. aureus* slightly decreased among both hospital- and community-acquired isolates  
84 (Diekema *et al.* 2019). Although bloodstream infections due to antibiotic-resistant bacteria  
85 currently represent a minority of cases, they can cause a higher fatality and mortality risks  
86 and a heavier economic burden per infection than susceptible isolates (Stewardson *et al.*  
87 2016; Hattori *et al.* 2018; Kern and Rieg 2020; MacKinnon *et al.* 2021). Beyond the high  
88 hospital costs associated with bloodstream infection care, long-term disabilities following  
89 severe sepsis have major socioeconomic impacts (Iwashyna *et al.* 2010).

90 The pathogenesis of bloodstream infection is a complex and dynamic process. In broad  
91 outline, it can be divided into several steps, starting with the invasion of the vascular system  
92 by bacteria, possibly after tissue colonization and dissemination from a primary site of  
93 infection, followed by interactions with blood immune components, potentially triggering  
94 sepsis. In some cases, it can be followed by metastatic spread to secondary sites of infection.  
95 Successful bloodstream infection relies on the capacity of bacteria to overcome host immune

96 defenses based on tissular barriers, liver and spleen clearance, immune cells, soluble  
97 messengers and antibacterial factors. Invading bacteria face phagocytosis by neutrophils,  
98 monocytes and macrophages. Killing occurs by the generation of toxic levels of reactive  
99 oxygen and nitrogen species, fine-tuning of the homeostasis of metal nutrients, and the  
100 production of antimicrobial peptides and proteases (Nathan 2006; Sheldon and Skaar 2019).  
101 In blood, complement kills bacteria directly by forming the lytic membrane attack complex and  
102 indirectly by mediating macrophage osponophagocytosis (Ricklin *et al.* 2010). Other  
103 antibacterial defense components of the blood include platelet microbicidal proteins (PMPs)  
104 and kinocidins released by alpha granules, interleukin 26, defensins and nutritional immunity  
105 proteins such as transferrin, hemopexin and haptoglobin (Hood and Skaar 2012; Yeaman  
106 2014; Larochette *et al.* 2019).

107 Several reviews have explored various stages of bloodstream infections, including  
108 bacterial adhesion, invasion, crossing of host barriers, vascular invasion, bacterial survival in  
109 blood or serum and dissemination (Lemichez *et al.* 2010; Miajlovic and Smith 2014; Abreu  
110 and Barbosa 2017; Coureuil *et al.*, 2017; Le Guennec *et al.* 2020; Holmes *et al.* 2021).  
111 However, these reviews focused on specific bacteria or specific barriers. Here, we propose a  
112 broader perspective by examining the molecular mechanisms evolved by a wide range of  
113 clinically relevant bacteria to resist host defenses and thrive in the bloodstream. This review  
114 will encompass established survival mechanisms like complement and antimicrobial peptide  
115 resistance, blood immune cell manipulation and subversion of nutritional immunity as well as  
116 how bacteria regulate these regulatory processes. It will not consider how bacteria enter the  
117 bloodstream and how they reach secondary sites of infection, due to the multiplicity of  
118 mechanisms and diversity of contexts. We will focus on bacterial determinants of viability that  
119 have been functionally validated in blood *ex vivo* and in animal models. Additionally, we  
120 provide an in-depth analysis of over 40 genome-wide studies to shed light on metabolic  
121 adaptations that enable bacterial survival and proliferation in blood. All in all, our review will  
122 explore the critical factors that empower some bacteria to flourish in blood and distinguish  
123 them from those that do not.

## 124 **Complement inhibitors**

125 The complement system (see Box 1) is one of the most important components of innate  
126 immune response. It mediates host defense and homeostasis in plasma, at infection sites  
127 and in intracellular space of some cell types. Complement deficiencies increase the risk for  
128 invasive bacterial infection. Complement resistance is a critical property shared by bacteria  
129 responsible for bloodstream infection, which developed mechanisms targeting virtually all  
130 complement components to interfere with the complement cascade. The following section  
131 highlights the key complement resistance factors expressed by bacteria that successfully  
132 survive in the bloodstream. Bacterial factors targeting components common to the classical  
133 pathway (CP), the lectin pathway (LP) and the alternative pathway (AP), such as C3 and C5,  
134 are illustrated in the Figure 2. Bacterial factors targeting components of the CP/LP, AP or TP  
135 are illustrated Figures 3, 4 and 5, respectively. Additionally, an extensive view of established  
136 bacterial factors evolved to resist complement is presented in Supplementary Tables 1-4. For  
137 a comprehensive panorama, the reader is referred to reviews considering general evasion  
138 mechanisms (Zipfel et al. 2007; Lambris et al. 2008; Hovingh et al. 2016; Ermert et al. 2019;  
139 Holmes *et al.* 2021) or focusing on factors expressed by specific bacteria, such as *E. coli*  
140 (Miajlovic and Smith 2014; Abreu and Barbosa 2017), *S. aureus* (Pietrocola *et al.* 2017), *K.*  
141 *pneumoniae* (Doorduyn *et al.* 2016), *P. aeruginosa* (González-Alsina *et al.* 2023), *Borrelia*  
142 *burgdorferi* (Dulipati *et al.* 2020), *Haemophilus influenzae* and *Moraxella catarrhalis*  
143 (Riesbeck 2020), *Leptospira* spp. (Barbosa and Isaac 2018), *Neisseria* spp. (Schneider *et al.*  
144 2007; Lewis and Ram 2020), *Salmonella* and *Yersinia* spp. (Krukonis and Thomson 2020),  
145 or *Streptococcus* spp. (Laabei and Ermert 2019; Syed *et al.* 2020).

146

### 147 **Inhibition of complement activation**

148 *S. aureus*, the most prominent bloodstream infection-associated Gram-positive  
149 bacterium, is exceptionally well equipped with surface components and secreted effectors  
150 that disrupt complement pathways at virtually every step of the cascade. Like other Gram-

151 positive bacteria, *S. aureus* is intrinsically resistant to the TP, owing to its thick peptidoglycan  
152 layer preventing membrane-attack complex (MAC) formation and subsequent bacterial lysis.  
153 The complement efficacy then only relies on its opsonization effect. However, *S. aureus* can  
154 also prevent CP activation by producing the staphylococcal protein A (SpA) (Kronvall and  
155 Gewurz 1970) and the second binding protein for immunoglobulins (Sbi) (Zhang *et al.* 1998),  
156 which inhibit Ig interaction with C1q, as described for the staphylococcal superantigen-like  
157 protein 10 (SSL10) (Itoh *et al.* 2010). Interestingly, SSL10 was also shown to bind  
158 prothrombin and factor Xa *in vitro* via their  $\gamma$ -carboxyglutamic acid (Gla) domain, interfering  
159 with the activation of the coagulation cascade (Itoh *et al.* 2013) (Supplementary Table 8).  
160 Aside from complement subversion, SpA also suppresses B cell response during  
161 bloodstream infection (Kim *et al.* 2015). Remarkably, *S. aureus* has been shown to target all  
162 C3 and C5 convertases from CP/LP and AP by expressing factors such as the extracellular  
163 adherence protein Eap that binds to C4b and prevents the formation of the C3 proconvertase  
164 C4b2 (Woehl *et al.* 2014), the staphylococcal complement inhibitor protein SCIN that blocks  
165 C4b2b and C3bBb(P) formation and function (Rooijackers *et al.* 2005b; Jongerius *et al.* 2007),  
166 the extracellular complement-binding protein Ecb and the extracellular fibrinogen-binding  
167 protein Efb which also inhibit the C3 convertase C3bBb(P) as well as C5 convertases  
168 C4b2bC3b and C3bBbC3b activity (Jongerius *et al.* 2007), thereby promoting bloodstream  
169 infection in a murine infection model (Jongerius *et al.* 2012). *S. aureus* produces another  
170 factor preventing opsonization, the staphylokinase, which binds and activates plasminogen  
171 into plasmin, leading to C3b and IgG degradation (Rooijackers *et al.* 2005a). Sbi and Efb also  
172 bind plasmin, triggering C3a, C3 and C3b degradation and resulting in reduced chemotaxis  
173 (Koch *et al.* 2012). By interacting with human fibrinogen, Efb promotes formation of a capsule-  
174 like structure which hampers C3b deposition and opsonophagocytosis (see next section) (Ko  
175 *et al.* 2013). Additionally, *S. aureus* expresses two small proteins, the superantigen like  
176 protein 7 (SSL7) and CHIPS (chemotaxis inhibitory protein of *Staphylococcus*), which bind  
177 C5 and C5aR, respectively, thereby interfering with C5a signaling and abrogating C5a-  
178 dependent chemotaxis (De Haas *et al.* 2004; Bestebroer *et al.* 2010).



179 Gram-negative bacteria evolved specific strategies to prevent MAC insertion in their outer  
180 membrane (OM) and overcome complement activation. *E. coli*, the bacterium the most  
181 frequently isolated from blood worldwide, produces the TraT protein, which inhibits C5b-C6  
182 interaction, thereby preventing MAC assembly and promoting bacterial survival in serum  
183 (Pramongjago *et al.* 1992). Lipopolysaccharide (LPS), in particular O-antigen, also  
184 contributes to complement resistance, possibly through reduction of membrane fluidity  
185 affecting MAC insertion (Taylor 1983) or deposition of complement components and MAC  
186 away from the OM, as it has been shown in several *S. enterica* serotypes (Joiner *et al.* 1982,  
187 1986) and *K. pneumoniae* (Merino *et al.* 1992). This relates to the observation that rough  
188 strains of *E. coli* that lack O-antigen are more sensitive to serum than smooth strains, in which  
189 LPS contains O-antigen (Johnson 1991). LPS can also interfere with the CP and LP. The  
190 LPS structure is believed to determine the level of binding of MBL, which is reduced by O-  
191 antigen and sialic acid in *Neisseria gonorrhoeae* and *S. enterica* serovar Typhimurium  
192 (Devyatyarova-Johnson *et al.* 2000). *H. influenzae* prevents IgM binding by altering the  
193 structure of its lipooligosaccharide (LOS - a particular type of LPS that lacks O-antigen)  
194 through incorporation of galactose, thereby reducing complement activation and neutrophil-  
195 mediated killing (Langereis and Weiser 2014). Furthermore, the phase-variable LOS  
196 biosynthesis gene *igtC* is necessary to minimize C4b deposition on *H. influenzae* surface (Ho  
197 *et al.* 2007). Bacterial surface structures, such as capsule, exopolysaccharide (EPS) or LPS  
198 can prevent C3/C3b deposition and opsonization, thereby reducing phagocytosis and  
199 promoting survival in blood. The bacterial components involved in these mechanisms are  
200 detailed in the section 'Phagocytosis escape'.

201 Degradation of complement components is another mechanism evolved by major  
202 bacteria responsible for bloodstream infection. For instance, *Streptococcus pyogenes*  
203 peptidase ScpA can cleave C3, C3a and C5a (Lynskey *et al.* 2017) and *E. coli* Pic  
204 autotransporter cleaves C2, C3, C3b, C4 and C4b (Abreu *et al.* 2015). However, a recent  
205 study underlined the importance of *in vivo* validation of effector activity demonstrated *in vitro*.  
206 Indeed, while *P. aeruginosa* alkaline protease AprA (or PaAP) degrades C1q, C3 (Hong and

207 Ghebrehiwet 1992), C1s and C2 (Laarman *et al.* 2012), and the elastase LasB (or PaE)  
208 degrades C1q and C3 (Hong and Ghebrehiwet 1992) *in vitro*; AprA- and LasB-deficient  
209 mutants are as virulent as a their parental strain in several animal models (Mateu-Borrás *et*  
210 *al.* 2022).

211 Interestingly, a recent study reported that Gram-negative bacteria such as *P. aeruginosa*,  
212 *A. baumannii*, *B. multivorans*, enteroaggregative *E. coli*, *K. pneumoniae* and *Y. enterocolitica*,  
213 can form sub-populations of complement evaders, which present a biphasic survival curve  
214 when exposed to serum and increased resistance to MAC (Pont *et al.* 2020). Mutants in genes  
215 of purine and biotin biosynthesis were further identified as persistence enhancers, while  
216 mutants in polyphosphate kinase genes had a decreased number of evaders upon incubation  
217 in plasma, establishing a link between metabolism and complement evasion (Janet-Maitre *et*  
218 *al.* 2023).

219

## 220 **Recruitment of complement inhibitors**

221 A common strategy used by bacteria to evade complement is the recruitment of  
222 complement inhibitors that regulate autologous complement activation to prevent  
223 inflammation and pathologies. For example, *E. coli* secretes the metalloprotease StcE that  
224 recruits and potentiates C1-INH, a serine protease inhibitor that negatively regulates C1r, C1s  
225 (CP), MASP-1 and MASP-2 (LP) on host cells, protecting adherent bacteria from complement  
226 (Lathem *et al.* 2004).

227 A majority of bacteria involved in bloodstream infections produces factors that interact  
228 with C4BP, the main negative regulator of CP and LP, to prevent complement activation, such  
229 as *E. coli* OmpA and NlpI (Wooster *et al.* 2006; Tseng *et al.* 2012). C4BP binding to *N.*  
230 *gonorrhoeae* porins Por1A and PorB1 and *Neisseria meningitidis* PorA has also been  
231 demonstrated to confer serum resistance (Ram *et al.* 2001; Jarva *et al.* 2005). In addition,  
232 gonococcal LOS structure plays a role in C4BP binding efficiency, as shown by a heptose  
233 glycan substitution enhancing serum resistance (Ram *et al.* 2007) or phosphoethanolamine  
234 residues from the lipid A promoting C4BP binding to PorB (Lewis *et al.* 2013).

235 The main negative regulators of the AP, i.e., factor H (fH), factor H-like (FHL-1) and factor  
236 H-related protein (FHR-1) (Ferreira et al. 2010), are also subverted by bacterial determinants  
237 of bloodstream infection, such as *A. baumannii* OmpA (Kim et al. 2009b), *E. coli* OmpW (Li  
238 et al. 2016) or *N. meningitidis* factor H binding protein fHBP (Madico et al. 2006). *N.*  
239 *meningitidis* NspA protein whose expression was initially shown to be induced in human blood  
240 (Echenique-Rivera et al. 2011), was later demonstrated to interact with factor H, like sialylated  
241 LOS, promoting serum resistance in *N. meningitidis* and *N. gonorrhoeae* (Lewis et al. 2012;  
242 Giuntini et al. 2015; Lewis et al. 2019). *S. aureus* has been shown to subvert both C4BP- and  
243 fH-mediated inhibition of complement. Indeed, staphylococcal clumping factor ClfA recruits  
244 factor I, the protease responsible for degradation of C4b via C4BP (CP and LP) and  
245 degradation of C3b via factor H (AP) (Hair et al. 2008), decreasing complement activation  
246 and opsonization. Interestingly, ClfA also allows staphylococci to associate with the fibrin  
247 cables resulting from the activation of prothrombin by the coagulases Coa and von Willebrand  
248 factor binding protein vWbp, ultimately promoting agglutination and infection severity in a  
249 mouse model of sepsis (McAdow et al. 2011) (Supplementary Table 8).

250 Inhibitors of MAC assembly such as heparin-regulated vitronectin, clusterin, COMP or  
251 CD59, can also be recruited or mimicked by bacteria. For instance, the Ldp moonlighting  
252 protein of *P. aeruginosa* binds both clusterin and vitronectin to inhibit the TP and promote  
253 bacteria survival in serum (Hallström et al. 2015).

254 Strikingly, some bacterial factors can inhibit CP, LP and AP by simultaneously binding to  
255 C4BP and fH such as *S. aureus* SrdE/Bbp (Sharp et al. 2012). Pathogenic *Yersinia* species  
256 and several *S. enterica* serotypes encode Ail and Rck proteins, respectively, which are  
257 homologous proteases shown to bind fH, C4BP, heparin, and to recruit vitronectin, inhibiting  
258 MAC formation by blocking its insertion and C9 polymerization. This mechanism enhances  
259 serum resistance in *S. enterica* (Heffernan et al. 1992; Ho et al. 2010; Ho et al. 2011), *Y.*  
260 *pestis* (Bartra et al. 2008, 2015; Ho et al. 2014; Shin et al. 2019; Thomson et al, 2019),  
261 *Yersinia enterocolitica* (Bliska and Falkow 1992; Biedzka-Sarek et al. 2008; Kirjavainen et al.  
262 2008) and *Yersinia pseudotuberculosis* (Ho et al. 2012). However, these interactions have

263 recently been shown to play a minor role in *Y. pestis* resistance to complement, while  
264 maintenance of membrane integrity by Ail contributes to serum resistance (Kolodziejek et al.  
265 2022).

266

### 267 **Combined subversion of complement activation and inhibition**

268 Some bacterial factors are Swiss army knives able to interact with multiple components  
269 and regulators of the different complement pathways, allowing protection at different levels of  
270 the activation cascades. For example, the *S. enterica* protease PgtE cleaves C3b, C4b, C5  
271 (Ramu *et al.* 2007), C3, factor B and factor H (Riva, Korhonen and Meri 2015), promoting  
272 serum survival. Intriguingly, PgtE is a homolog of *Yersinia pestis* virulence factor Pla that has  
273 been shown to activate plasminogen but does not affect bacterial survival in serum nor during  
274 bloodstream infection (Sebbane *et al.* 2006; Sebbane, Uversky and Anisimov 2020). *S.*  
275 *pyogenes* protease SpeB cleaves C1-INH, C2, C3, C3b, C4, C5a, C6, C7, C8, C9 and  
276 degrades properdin, assuring inactivation of complement at all stages of the cascade (Tsao  
277 *et al.* 2006; Kuo *et al.* 2008; Terao *et al.* 2008).

278 Other mechanisms such as complement exhaustion by outer membrane vesicles (OMV)  
279 have been described in bacteria (Supplementary Table 5), but their significance during  
280 bloodstream infection remains to be determined. Additionally, new bacterial determinants of  
281 complement resistance, including envelop components, are currently under investigation  
282 (Supplementary Table 6).

283

## 284 **Bacterial factors subverting blood cell defenses**

285 In addition to the complement system, bacteria are confronted with innate immune cells  
286 when entering the bloodstream. Many of these cells are patrolling neutrophils and monocytes  
287 involved in phagocytic killing of microbes, and platelets which carry out haemostasis and  
288 antimicrobial functions (Jenne *et al.* 2013; Yeaman 2014). Bacteria engaged in bloodstream  
289 infection display factors allowing phagocyte or platelet subversion. In this section, we highlight  
290 the main subversion mechanisms discovered to date and illustrated in Figure 6. Extensive  
291 inventories of factors subverting phagocytes and platelets can be found in Supplementary  
292 Tables 7 and 8, respectively.

### 294 **Phagocytosis escape**

295 Complement and antibodies play an important role in phagocytosis through opsonization  
296 of bacteria via C3b or IgG for example, facilitating their uptake by monocytes/macrophages  
297 and neutrophils. This phenomenon called opsonophagocytosis is widely counteracted by  
298 bacterial factors inhibiting complement action described in the previous section and by the  
299 capsule expressed by some bacteria. The effect of *S. enterica* capsule on  
300 opsonophagocytosis was described almost 90 years ago (Bhatnagar 1935; Felix and  
301 Bhatnagar 1935). Capsule production decreases opsonin deposition, lowering uptake by  
302 neutrophils upon interaction with *Bacillus anthracis* (Sharma *et al.* 2020), *E. coli* (Horwitz and  
303 Silverstein 1980; Sarkar *et al.* 2014), *K. pneumoniae* (Álvarez *et al.* 2000), *B. pseudomallei*  
304 (Reckseidler-Zenteno *et al.* 2005), and some *Streptococcus* species (Locke *et al.* 2007;  
305 Hyams *et al.* 2010), as well as uptake by macrophages or monocytes in contact with *E. coli*  
306 (Horwitz and Silverstein 1980; Sarkar *et al.* 2014), *H. influenzae* (Noel *et al.* 1996), *S. enterica*  
307 (Wilson *et al.* 2011; Hart *et al.* 2016) and *S. aureus* (Thakker *et al.* 1998). Interestingly, a  
308 recent report highlighted cell-type dependent effects of *S. enterica* Vi capsule, which was  
309 shown to inhibit phagocytosis by human neutrophils and to promote human macrophage  
310 phagocytosis by binding DC-SIGN lectin (Zhang *et al.* 2022). It has also been suggested that

311 the capsule can mask C3 deposited on the cell wall from phagocyte receptors (Watts *et al.*  
312 2005; Thurlow *et al.* 2009), as well as hide pathogen-associated molecular patterns (PAMPs)  
313 such as lipoteichoic acid (LTA) or peptidoglycan (PG) from pattern recognition receptors  
314 (PRRs), dampening immune responses (Thurlow *et al.* 2009). Furthermore, a recent report  
315 showed that inactivation of the glycosyltransferase Gtr6 of a hypervirulent *A. baumannii*  
316 clinical isolate modifies capsule acetylation and protects bacteria from C3b deposition,  
317 phagocytosis in vitro and clearance from blood in vivo, resulting in lethal infection in mice  
318 (Talyansky *et al.* 2021). This study highlights the importance and possible evolution of  
319 bacterial surface structure for immune escape. Other surface factors reducing  
320 opsonophagocytosis include enterococcal polysaccharide (EPA) (Xu *et al.* 2000; Smith *et al.*  
321 2019), and exopolysaccharide (EPS) (Mishra *et al.* 2012) or proteins such as *S. pneumoniae*  
322 neuraminidase NanA acting on human glycoconjugates at the surface of bacteria to reduce  
323 C3 deposition (Dalia *et al.* 2010).

324 Apart from the opsonization decrease, pathogens evolved other mechanisms to prevent  
325 phagocytosis such as binding to fibronectin and/or to fibrinogen (Palmqvist *et al.* 2004;  
326 Higgins *et al.* 2006; Jung *et al.* 2009), or to erythrocyte CR1, protecting bacteria from uptake  
327 (Brekke *et al.* 2011). For example, the enterococcal surface protein ElrA reduces bacterial  
328 adherence to macrophages and internalization (Cortes-Perez *et al.* 2015). In contrast,  
329 *Streptococcus suis* protein HP0487 was recently shown to promote neutrophil adhesion while  
330 reducing phagocytosis (Hui *et al.* 2021). Interestingly, *S. aureus* and *B. anthracis* lacking the  
331 adenosine synthase A AdsA have a reduced capacity to prevent phagocytic clearance in  
332 blood. Abscess formation by *S. aureus* was dependent on AdsA and could be rescued in an  
333 *adsA* mutant by exogenous supply of adenosine, a known immune regulator. This suggests  
334 that these pathogens can subvert phagocytic clearance by controlling adenosine levels  
335 (Thammavongsa *et al.* 2009).

336

337

338 **Phagocyte and platelet impairment**

339 Bacteria involved in bloodstream infection can directly target phagocytes and platelets to  
340 prevent phagocytosis and immune response. For example, *S. aureus* can lyse neutrophils by  
341 producing small cytotoxic alpha-helical peptides called phenol-soluble modulins (PSMs)  
342 (Wang *et al.* 2007). It has been further shown that the leucocidin LukED directly kills  
343 phagocytes, thereby promoting bloodstream infection in mice (Alonzo *et al.* 2012). Expression  
344 of gamma hemolysin HlgABC is highly upregulated in human blood and contributes to lysis  
345 of human neutrophils upon secretion by extracellular *S. aureus*. However, HlgABC has a  
346 modest contribution to virulence in a mouse bacteremia model of infection, presumably due  
347 to functional redundancy with other leukotoxins (Malachowa and DeLeo 2011; Malachowa *et*  
348 *al.* 2011). An indirect phagocyte targeting mechanism was recently discovered, involving the  
349 staphylococcal superantigens (Sags) which promote bloodstream infection through  
350 modulation of IFN- $\gamma$  production by CD4-positive T cells, impairing macrophage function in the  
351 liver and bacterial clearance (Tuffs *et al.* 2022).

352 Some Gram-negative bacteria involved in bloodstream infection directly inject cytotoxic  
353 effectors into the cytoplasm of phagocytes. For example, *Y. pestis* intoxicates macrophages  
354 and neutrophils via injection of the *Yersinia* outer proteins (Yops) by its type 3 secretion  
355 system (T3SS) during bloodstream infection (Marketon *et al.* 2005). These Yops display  
356 antiphagocytic properties and can trigger apoptosis and pyroptosis of immune cells,  
357 promoting infection (Pinaud *et al.* 2018; Demeure *et al.* 2019; Chen and Brodsky 2023).  
358 Among Yops, YopM has been shown to inhibit thrombin and ristocetin-induced platelet  
359 aggregation (Leung *et al.* 1990; Palace *et al.* 2020). This latter study also highlighted the role  
360 of the plasminogen activator Pla in this mechanism. However, Pla has previously been shown  
361 to be dispensable in a septicemic plague model (Sebbane *et al.* 2006). Similar to *Y. pestis*,  
362 *P. aeruginosa* T3SS-injected Tox effectors are required for survival in blood (Vance *et al.*  
363 2005). *S. enterica* SPI-2 T3SS and non-typhoid strain Spv effectors enable systemic infection  
364 by promoting the intracellular lifestyle of bacteria and impairing phagocyte survival (Guiney

365 and Fierer 2011; Jennings et al. 2017; Pinaud et al. 2018). Yet, their exact roles in  
366 bloodstream dissemination and survival in blood remain to be clarified.

367 While the immune role of platelets has long been overlooked, a recent study described a  
368 new factor playing a dual role in platelet resistance by *Streptococcus agalactiae*. Indeed, sialic  
369 acids (Sia) decorating its capsule polysaccharide (CPS) promote resistance to platelet killing  
370 and particularly to platelet antimicrobial peptides. Moreover, Sia bind platelet lectin Siglec-9,  
371 thereby inhibiting their activation and promoting *S. agalactiae* blood infection (Uchiyama et  
372 al. 2019).

373 Aggregation and exhaustion of neutrophils can be triggered to evade phagocytes, as  
374 reported with *S. suis* muramidase-released protein MRP, which interacts with human  
375 fibrinogen, and subsequently with neutrophils via an  $\alpha_x\beta_2$  integrin-dependent mechanism  
376 (Pian et al. 2016). Similar strategies are used to deplete platelets from the bloodstream  
377 leading to thrombocytopenia. Dysregulation of platelet activation is a mechanism shared by  
378 various bacteria such as *B. anthracis*, whose peptidoglycan activates platelets in a Fc $\gamma$ RII-  
379 and complement-dependent manner (Sun et al. 2013), contributing to the disseminated  
380 intravascular coagulation (DIC) necessary for *B. anthracis* pathogenesis (Qiu et al. 2013). *In*  
381 *vitro* studies of staphylococcal SSL5 also showed activation of platelets through glycoproteins  
382 Iba and  $\alpha$ IIb $\beta$ 3 interaction (De Haas et al. 2009). The pneumococcal neuraminidase NanA,  
383 mentioned in the previous section, also removes surface sialic acids from cells, increasing  
384 platelets activation as well (Syed et al. 2019).

385 Interestingly, *S. pyogenes* was recently shown to induce thrombocytopenia by a new  
386 mechanism exploiting phagocytes. The streptococcal M1 protein is indeed able to form a  
387 complex with fibrinogen, Ig and complement components in plasma, and to bind to platelet  
388 surface, thus enhancing their phagocytosis by monocytes (Palm et al. 2019).

389



390

391 **Resistance to phagocyte defenses**

392 Many bacteria that do not escape phagocytosis or cannot impede immune cells produce  
393 factors preventing intracellular killing. Reactive oxygen species (ROS) are among the most  
394 potent weapons of phagocytic cells. Bacteria evolved mechanisms to counteract ROS-  
395 mediated toxicity. For instance, *S. aureus* synthesizes the antioxidant staphyloxanthin (STX),  
396 a membrane-embedded carotenoid pigment which enhances resistance to ROS produced by  
397 phagosomal NADPH oxidase NOX2, promoting bacterial survival in phagocytes and virulence  
398 (Hall *et al.* 2017). The antioxidant activity of superoxide dismutases (SOD) SodA, SodB  
399 and/or SodC also plays a role in ROS resistance and virulence in *S. enterica* (De Groote *et*  
400 *al.* 1997; Farrant *et al.* 1997; Fang *et al.* 1999; Ammendola *et al.* 2005), *V. vulnificus* (Kang  
401 *et al.* 2007), *B. pseudomallei* (Vanaporn *et al.* 2011), *S. agalactiae* (Poyart *et al.* 2001; Zhu *et*  
402 *al.* 2020), *S. suis* (Tang *et al.* 2012), *N. meningitidis* (Wilks *et al.* 1998), and *Y. enterocolitica*  
403 (Roggenkamp *et al.* 1997). While *S. aureus* superoxide dismutase activity was not correlated  
404 with virulence *in vivo*, its catalase activity protected bacteria against neutrophil killing (Mandell  
405 1975). Specific catalases were thereafter shown to promote infection such as leptospiral KatE  
406 (Eshghi *et al.* 2012), *P. aeruginosa* KatA (Kim *et al.* 2009a) or *H. influenzae* HktE (Bishai *et*  
407 *al.* 1994). Singularly, *S. aureus* can exist as small-colony variants (SCVs), which often lack a  
408 functional electron transport chain and do not produce leucocidins, hemolysins and STX.  
409 Despite absence of these virulence factors, SCVs can survive in blood due to their reduced  
410 sensitivity to neutrophil oxidative burst linked to their defective electron transport system. This  
411 observation was confirmed by electron transport restoration in a strain of *E. faecalis* whose  
412 electron transport chain was naturally non-functional, leading to a decreased survival in blood  
413 (Painter *et al.* 2017).

414 Glutamate also plays an important role in ROS resistance. When converted to  
415 glutathione, it allows a balanced intracellular redox potential promoting *N. meningitidis*  
416 bacteremia and resistance to neutrophil ROS (Talà *et al.* 2011). This mechanism emphasizes  
417 the importance of glutamate importers such as GltT or NMB1966 in *N. meningitidis* virulence

418 potential (Sun *et al.* 2000; Li *et al.* 2009; Talà *et al.* 2011; Capel *et al.* 2017). Along the same  
419 line, the glutamate dehydrogenase GdhA, which is upregulated when *N. meningitidis* is grown  
420 in whole blood (Echenique-Rivera *et al.* 2011), was shown to be required for systemic  
421 infection (Sun *et al.* 2000; Liu *et al.* 2016; Capel *et al.* 2017). Interestingly, *S. enterica* ortholog  
422 of GdhA has recently been shown to convert ammonia to glutamate which is in turn converted  
423 to glutathione, promoting resistance to ROS and intracellular survival (Huang *et al.* 2022),  
424 which could explain the contribution of GdhA in *N. meningitidis* pathogenicity.

425 In addition to ROS, phagolysosome acidic environment plays a role in pathogen killing.  
426 *S. enterica* withstands phagosomal acidity by producing the virulence protein MgtC. In  
427 contrast to other effectors, MgtC does not target vacuolar ATPase but it binds bacterial F<sub>1</sub>F<sub>o</sub>  
428 ATP synthase, inhibiting proton translocation and ATP synthesis allowing maintenance of a  
429 physiological ATP level and intracellular pH by bacteria replicating inside acidic phagosomes  
430 and thereby promoting systemic infection (Lee *et al.* 2013). The role of this mechanism in  
431 bacteremia remains to be fully deciphered. Neutrophils can also trigger NETosis, a specific  
432 cell death program that promotes formation of neutrophil extracellular traps (NET) by  
433 releasing a net made of DNA, histones, granular proteins and antimicrobial peptides, trapping  
434 and degrading microbes (Vorobjeva and Chernyak 2020). Some bacteria encode  
435 endonucleases or DNases to evade NETs, increasing their survival in blood, such as for *S.*  
436 *pyogenes* Sda1 DNase (Buchanan *et al.* 2006).

437 Antimicrobial metal sequestration or intoxication by phagocytes and their subversion by  
438 bacteria will be developed in the section 'Bacterial factors subverting nutritional immunity'.  
439

## 440 **Antimicrobial peptide resistance factors**

441 Antimicrobial peptides (AMPs) are defense components of all living organisms that can  
442 kill not only bacteria, but also viruses, parasites and fungi by a variety of mechanisms  
443 including membrane destabilization (Bahar and Ren 2013). Resistance to AMPs contributes  
444 to the subversion of the immune system by bacteria during the blood phase of infection.  
445 Bacterial factors promoting resistance to AMPs and survival in blood or systemic infection are  
446 presented in Supplementary Table 9.

447

### 448 **Factors modifying the charge of bacterial surface**

449 An AMP resistance mechanism widely used by bacteria consists in reduction of the  
450 negative charge of their surface, preventing the electrostatic attraction of cationic defense  
451 molecules. This is in part mediated by expression the *dltABCD* operon and the *mprF* gene,  
452 responsible for D-alanylation of teichoic acids and lysinylation of membrane  
453 phosphatidylglycerol, respectively, in Gram-positive bacteria such as *S. agalactiae* (Poyart *et al.*  
454 *2003*), *S. pneumoniae* (Kovács *et al.* 2006; Wartha *et al.* 2007), *S. suis* (Fittipaldi *et al.*  
455 *2008*), *B. anthracis* (Fisher *et al.* 2006; Samant *et al.* 2009), *S. aureus* (Collins *et al.* 2002;  
456 Weidenmaier *et al.* 2005) and *L. monocytogenes* (Abachin *et al.* 2002; Thedieck *et al.* 2006).  
457 In *S. aureus*, this surface charge modification is associated with increased resistance to  
458 endogenous cationic antimicrobial peptides, such as  $\alpha$ -defensins, and to thrombin-induced  
459 platelet microbicidal protein 1 (tPMP-1), promoting infection in a rabbit endocarditis model  
460 (Weidenmaier *et al.* 2005).

461 Interestingly, a similar mechanism of amino acid addition to the lipid A, enhancing AMP  
462 resistance and intestinal colonization, has been more recently described in *V. cholerae*  
463 (Hankins *et al.* 2012; Herrera *et al.* 2014). However, its implication in bloodstream infection  
464 remains to be elucidated. Reduction of the negative charge of LPS or LOS lipid A, via  
465 aminoarabinose addition for example, is a common mechanism of AMP resistance among  
466 Gram-negative bacteria (Needham and Trent 2013). While this mechanism can play a role in

467 virulence via peripheral route of infection (Gunn *et al.* 2000), few studies have highlighted its  
468 importance in blood survival. For example, the loss of phosphoethanolamine (PEA)  
469 substitution from *N. gonorrhoeae* lipid A mediated by the PEA transferase LptA, has been  
470 shown to increase susceptibility to polymyxin B, but the observed increased sensitivity to  
471 serum killing was mainly due to the classical complement pathway (Lewis *et al.* 2009).

472 *N. meningitidis* fHBP is also involved in resistance to the antimicrobial peptide LL-37,  
473 which could be mediated by their electrostatic interactions (Seib *et al.* 2009), besides its  
474 aforementioned key role in complement inhibition.

475

### 476 **Potassium transporters**

477 Interestingly, the potassium importer Trk/Sap is an AMP resistance factor shared by  
478 several bacterial species, possibly by maintaining potassium homeostasis while AMPs target  
479 the bacterial surface. The *V. vulnificus trkA* potassium transport gene has been shown to be  
480 involved in resistance to AMPs such as protamine or polymyxin B, and to contribute to serum  
481 resistance and virulence in mouse models of infection (Chen *et al.* 2004). The SapG  
482 potassium transporter of *S. enterica* serovar Typhimurium also contributes to protamine  
483 resistance (Parra-Lopez *et al.* 1994) and virulence in a mouse model of infection (Groisman  
484 *et al.* 1992). While the exact mechanism of resistance remains unknown, it was suggested  
485 that *S. enterica* secreted virulence factors were regulated by the Trk transporter (Su *et al.*  
486 2009). Additionally, a genome-wide screen highlighted the importance of the *sapABCDF*  
487 operon for *E. coli* systemic infection in mice (Subashchandrabose *et al.* 2013). AMP  
488 resistance *in vitro* or *in vivo* mediated by a similar transporter has been reported in *Y.*  
489 *enterocolitica* (Bengoechea and Skurnik 2000) and *H. influenzae* (Mason, Munson and  
490 Bakaletz 2005; Mason *et al.* 2006). However, its role in bloodstream infection was not  
491 assessed.

492

493

#### 494 **Other mechanisms of resistance to AMPs**

495 AMPs can act in several bodily fluids as well as intracellularly, in particular in phagosome  
496 in which they contribute to kill bacteria. PilB, the major pilus protein of *S. agalactiae* has been  
497 shown to mediate resistance to LL-37, presumably upon sequestering the AMP, promoting  
498 resistance to neutrophil killing, survival in macrophages and bloodstream infection (Maisey *et*  
499 *al.* 2008).

500 Several studies have identified new AMP resistance factors whose mechanisms of action  
501 remain to be deciphered. They are listed in Supplementary Table 9.

502

#### 503 **Bacterial factors subverting nutritional immunity**

504 Metals are essential structural and catalytic cofactors of proteins involved in cellular  
505 homeostasis in all living organisms. Pathogenic bacteria evolved mechanisms to subvert  
506 nutritional immunity by which host controls infection through metal limitation and intoxication  
507 (Murdoch and Skaar 2022) (Figure 7, Supplementary Table 10).

508

#### 509 **Iron**

510 Iron (Fe) has been identified as one of the key metals regulating virulence in pathogenic  
511 bacteria reaching the bloodstream, where iron is mainly bound to transferrin and to heme in  
512 hemoproteins such as hemoglobin. Bacteria have developed diverse highly efficient systems  
513 to capture iron from host iron-binding proteins (Murdoch and Skaar 2022). Secretion and  
514 uptake of siderophores, which are high affinity metal ion chelators, is an efficient mechanism  
515 of iron acquisition that is widespread in bacteria. The *Serratia marcescens* siderophore  
516 serratiochelin is required for growth in human serum and bacteremia (Weakland *et al.* 2020).  
517 The ferric enterobactin receptor FepA was identified as essential for *A. baumannii* virulence  
518 along with the iron transporter FeoB using a TRaDIS screen in a mouse model of bacteremia  
519 (Subashchandrabose *et al.* 2016). The operon of the previously mentioned siderophore Ybt

520 is located on a mobile element, the high pathogenicity island (HPI) that was horizontally  
521 acquired by or from other bacteria such as APEC or ExPEC, in which Ybt has recently been  
522 shown to promote bloodstream infection (Huja *et al.* 2015; Johnson *et al.* 2018). In *K.*  
523 *pneumoniae* Ybt is not essential for serum survival in contrast to enterobactin and  
524 salmochelin (Bachman *et al.* 2011). In Gram-negative bacteria, import of siderophores and  
525 other molecules widely relies on the TonB-ExbB-ExbD system allowing energy transduction  
526 through the envelope. *A. baumannii* TonB3 was indeed shown to contribute to bacterial serum  
527 survival and virulence (Runci *et al.* 2019). A similar role was uncovered in *K. pneumoniae*  
528 (Hsieh *et al.* 2008), *N. meningitidis* (Sun *et al.* 2000; Capel *et al.* 2017) and *Y. pestis* (Palace  
529 *et al.* 2014).

530 To acquire iron, some bacteria also possess ferrous and ferric iron transporters. Some of  
531 them are required for full virulence and blood survival, such as the SitABCD ATP-binding  
532 cassette (ABC) transporter mediating uptake of ferrous iron and manganese through the inner  
533 membrane (IM) in avian pathogenic *E. coli* (Sabri *et al.* 2008) and *S. enterica* (Boyer *et al.*  
534 2002; Zaharik *et al.* 2004). In contrast, mutation of *Y. pestis* *yfe* iron IM transporter gene does  
535 not reduce virulence in a model of septicemic plague. However, inactivation of both *Yfe* and  
536 *yersiniabactin* leads to virulence attenuation in this model, suggesting a redundancy of these  
537 iron import systems since Ybt is not required for septicemic plague (Perry *et al.* 2015).

538 Other bacteria produce factors that directly capture transferrin or heme to circumvent free  
539 iron scarcity in the blood. For example, the *N. meningitidis* transferrin binding protein TbpA is  
540 essential for virulence in a mouse model of bacteremia, and for bacterial growth in human  
541 blood (Renauld-Mongénie *et al.* 2004; Bidmos *et al.* 2015).

542 *N. meningitidis* iron uptake also relies on the hemoglobin receptor HpuAB and HmbR, a  
543 second hemoglobin binding protein, required for virulence in a rat model in absence of HpuAB  
544 (Stojjkovic *et al.* 1995). However, this phenotype was not reproduced when assessing early  
545 bacterial survival in human blood, contrary to TbpA, suggesting a role of HmbR in later stages  
546 of the infection process when blood transferrin levels decrease and hemoglobin levels  
547 increase due to erythrocyte lysis (Bidmos *et al.* 2015). The streptococcal hemoprotein

548 receptor protein Shr has also been demonstrated to be important for iron uptake in human  
549 blood and for *S. pyogenes* virulence in mouse models of skin and systemic infection (Dahesh  
550 et al. 2012). Likewise, the surface hemoglobin receptor IsdB transfers iron bound heme to  
551 other Isd components and eventually inside *S. aureus*. IsdB is required for full virulence in  
552 various mouse models (Torres *et al.* 2006; Pishchany *et al.* 2010, 2014). In *S. aureus*  
553 leucocidins LukED and HlgAB bicomponent toxins have been involved in iron acquisition as  
554 they lyse erythrocytes by targeting the Duffy antigen receptor for chemokines (DARC).  
555 Consequently, these toxins promote growth of *S. aureus* in a hemoglobin-acquisition-  
556 dependent manner and contribute to infection in mice (Spaan *et al.* 2015).

557

## 558 **Manganese**

559 Manganese (Mn) is another metal cofactor required for all forms of life. It can be  
560 sequestered by immune cell effectors such as calprotectin, thereby reducing Mn-cofactored  
561 superoxide dismutase activity and oxidative stress resistance, as shown in *Streptococcus*  
562 *sanguinis* (Crump *et al.* 2014; Zhu *et al.* 2021). Bacteria produce several broadly conserved  
563 classes of Mn importers. The Natural Resistance-Associated Macrophage Protein (NRAMP)  
564 family is a major class of proton-powered Mn importers expressed in mammals, plants,  
565 insects and bacteria in which they are generally named MntH. Both MntH and SitABC  
566 transport systems have been shown to play an important role in *S. enterica* virulence in  
567 NRAMP1 expressing mice, while MntH was not required in a SitABC mutant background and  
568 in NRAMP1 defective mice which cannot deplete Mn and Fe from intracellular compartments  
569 (Boyer *et al.* 2002; Zaharik *et al.* 2004). In a similar competition scenario, *S. aureus* MntH and  
570 MntABC transporters have been shown to be induced in presence of calprotectin during the  
571 course of systemic infection (Kehl-Fie *et al.* 2013).

572 High amounts of Mn can also be toxic for bacteria, as highlighted by the importance of  
573 the *N. meningitidis* Mn<sup>2+</sup> exporter MntX in regulating the intracellular Mn/Fe ratio and  
574 preventing manganese toxicity, which is exacerbated in low iron conditions. MntX was shown  
575 to be important to resist killing by human serum and for bacterial survival in mouse blood in

576 a model of septicemia following intraperitoneal inoculation (Veyrier *et al.* 2011). More recently,  
577 MntE, a member of the cation diffusion facilitator protein family, was shown to prevent  
578 excessive intracellular Mn accumulation. Deletion of the MntE gene led to a reduced tolerance  
579 to oxidative stress and decreased virulence during systemic infection with *S. suis* (Xu *et al.*  
580 2017) and *S. aureus* (Grunenwald *et al.* 2019). The latter study linked Fe homeostasis to Mn  
581 efflux.

582

### 583 **Zinc**

584 Similar to Fe and Mn, zinc (Zn) is an important cofactor for various enzymes, such as  
585 superoxide dismutases, and is also sequestered by the host immunity protein calprotectin.  
586 Bacteria subvert this restriction by expressing Zn importers. For example, the AdcABC  
587 transporter is required for Zn import into the cytoplasm of Gram-positive bacteria and  
588 promotes blood survival and systemic infection in several *Streptococcus* species (Bayle *et al.*  
589 2011; Le Breton *et al.* 2013; Ong *et al.* 2018; Zhu *et al.* 2020). The high affinity IM zinc  
590 transporter ZnuABC is required for systemic infection with the Gram-negative *S. enterica*  
591 (Ammendola *et al.* 2007) in synergy with the low affinity Zn transporter ZupT (Cerasi *et al.*  
592 2014). While outer membrane (OM) crossing has long been overlooked, it has been observed  
593 that the conserved outer membrane protein (OMP) zinc-uptake component D ZnuD is induced  
594 when *N. meningitidis* is incubated in whole blood (Echenique-Rivera *et al.* 2011). ZnuD  
595 functions as a gated pore in the OM, importing Zn ions (Calmettes *et al.* 2015). ZnuD is  
596 required for efficient systemic infection with *N. meningitidis* (Calmettes *et al.* 2015) and *A.*  
597 *baumannii* (Hesse *et al.* 2019). However, the latter study highlighted different contributions of  
598 OMP ZnuD and IM ZnuABC depending on infected tissues.

599 Similar to *yfe*, a deletion of *znuABC* alone is not sufficient to reduce *Y. pestis* virulence in  
600 a model of septicemic plague. However, the HMWP2 protein involved in Ybt siderophore  
601 production is required for growth of a *znuABC* mutant in zinc-deficient conditions and for  
602 septicemic plague. It has been suggested that the Zn-binding siderophore Ybt may serve as  
603 a zincophore for Zn<sup>2+</sup> acquisition which also relies on YbtX, a member of the major facilitator



604 superfamily (Bobrov *et al.* 2014). Similarly, *S. aureus* uses two importers, the AdcABC  
605 permease and the CntABCD transporter that can import the metallophore staphylopin (StP),  
606 enabling bacteria to compete with the host for zinc and promote systemic infection (Grim *et*  
607 *al.* 2017).

608 Zn intoxication can take place as an immune response to infection, and Zn export  
609 systems have been evolved by bacteria to survive this toxicity, as exemplified by  
610 streptococcal CzcD export protein (Ong *et al.* 2018; Zhu *et al.* 2021). Interestingly, Zn  
611 tolerance can differ between bacterial species. Indeed, *S. pyogenes* faces zinc toxicity upon  
612 phagocytosis by neutrophils and nutritional immunity extracellularly (Ong *et al.* 2018). In  
613 contrast, a *S. sanguinis* *czcD* mutant showed impaired growth extracellularly in human serum,  
614 which contains higher Zn concentration than saliva, the usual commensal niche of *S.*  
615 *sanguinis* (Zhu *et al.* 2021).

616

#### 617 **Other metals**

618 Copper is used by macrophages to kill phagocytosed bacteria but is also required as a  
619 cofactor of important bacterial enzymes such as Cu/Zn SOD SodC. Many bacteria encode  
620 the IM copper exporter CopA (formerly known as CueA), which is required for full virulence in  
621 *S. pneumoniae* (Johnson *et al.* 2015) and *P. aeruginosa* (Schwan *et al.* 2005) but not in *S.*  
622 *enterica* (Fenlon and Slauch 2017). Several copper resistance factor such as copper exporter  
623 or oxidase have been described in *S. enterica* but their involvement in virulence seems strain  
624 specific and varies according to the route of infection (Hyre *et al.* 2021). In *L. monocytogenes*  
625 the copper transporter CtpA is required to establish a systemic infection, but the exact  
626 virulence mechanism remains unknown (Francis and Thomas 1997).

627 Calcium can also be toxic to bacteria that developed mechanisms to regulate its  
628 concentration. A *S. pneumoniae* *caxP* mutant accumulated intracellular calcium and had a  
629 defective growth in sheep blood, human plasma and human serum, as well as a reduced  
630 virulence in mice (Rosch *et al.* 2008).

631 High level of sodium can be toxic as well, and it has been reported that inactivation of Y.

632 *pestis* Na<sup>+</sup>/H<sup>+</sup> antiporters NhaA and NhaB abolishes virulence, possibly by sensitizing  
633 bacteria to Na<sup>+</sup> toxicity in blood (Minato *et al.* 2013).

634 Magnesium (Mg) divalent cation has several biological functions, including as an  
635 enzymatic cofactor and a neutralizer of negatively charged macromolecules. The magnesium  
636 transporter MgtB has been shown to contribute to systemic infection in several *Yersinia*  
637 species, as *mgtB* mutants have a low competitive index after intravenous injection (Stubben  
638 *et al.* 2009; Ford *et al.* 2014). A similar function of MgtB was more recently described in *S.*  
639 *marcescens* (Anderson *et al.* 2017) and *S. enterica* (Choi *et al.* 2017). A recent breakthrough  
640 study identified SLC11A1 (NRAMP1) as the main Mg restrictor inside phagocytes leading to  
641 resistance against *S. enterica* infection (Cunrath and Bumann 2019). Expectedly, MgtB is  
642 required for *S. enterica* virulence in NRAMP1 positive but not in NRAMP1 negative mice.

643 Nickel plays a role in nutritional immunity, being sequestered by calprotectin. As a  
644 cofactor of several redox and non-redox enzymes produced by bacteria, it is required for  
645 diverse metabolic processes during infection (see next section). A recent transcriptomic study  
646 of porcine ExPEC in bloodstream of infected animals and in swine blood *ex vivo* revealed an  
647 upregulation of the expression of the nickel transporter NikABCDE, which was also shown  
648 to contribute to bacterial growth in swine blood and in infected mice (Ma *et al.* 2020).

649 Cobalt also serves as a cofactor for several bacterial proteins, but its implication in  
650 nutritional immunity is unclear. A screen of *S. sanguinis* mutants in human serum identified  
651 transporter genes of the energy coupling factor (ECF) family, *ecfA2*, *ecfT*, and *stpA*, whose  
652 single mutants and the triple mutant were shown to have decreased survival in human serum  
653 (Zhu *et al.* 2021). These genes were annotated as cobalt transporters, but their exact function  
654 and substrate remain to be characterized.

## 655 **Bacterial metabolic factors**

656 Nutrients and compounds vary greatly within hosts, defining multiple biogeochemical  
657 microhabitats in which bacteria adapt their metabolism, in particular when they reach the  
658 blood during the infection process (Olive and Sasseti 2016). Metabolism includes several  
659 components such as glycolysis, gluconeogenesis, citric acid cycle/tricarboxylic acid cycle  
660 (TCA), and pentose phosphate pathway (PPP) for carbon metabolism, nitrogen and sulfur  
661 metabolisms and oxidative phosphorylation for energy production and nucleotide and amino  
662 acid metabolisms (Kanehisa and Goto 2000; Kanehisa *et al.* 2023). The link between  
663 metabolism and virulence was recently reviewed using *S. enterica* as a model (Pokorzynski  
664 and Groisman 2023). In this section we propose to focus on some metabolic pathways  
665 required for bacterial survival into host blood. While specific metabolic pathways have been  
666 only studied in a restricted set of bacteria, we will take advantage of the conservation of  
667 bacterial metabolism and of the numerous genome-wide screens performed in conditions  
668 mimicking bacteremia (see Box 2) to draw conclusions on general metabolic requirements  
669 during bloodstream infection, which are summarized in the Supplementary Tables 11, 12, 13  
670 and 14.

671

### 672 **Nucleotide metabolism**

673 Systemic virulence has been linked to nucleotide and related metabolite auxotrophy since  
674 the 1950's in bacteria such as *S. enterica* (Bacon, Burrows and Yates 1950, 1951; Gowen *et*  
675 *al.* 1953; Formal, Baron and Spilman 1954), *K. pneumoniae* (Garber, Hackett and Franklin  
676 1952), *B. pseudomallei* (Levine and Maurer 1958), and later in *B. anthracis* (Ivánovics, Marjai  
677 and Dobozy 1968) or *Y. pestis* (Brubaker 1970). *S. enterica* purine-auxotrophic mutants  
678 revealed the crucial role in virulence of PurA and PurB, involved in adenosine  
679 monophosphate (AMP) biosynthesis from inosine monophosphate (IMP), as well as guanine  
680 monophosphate (GMP) biosynthesis proteins GuaA and GuaB, depending on the strain. The  
681 role in *S. enterica* virulence of PurC, PurD, PurF, PurG (or PurL) and PurH, involved in IMP

682 biosynthesis, was less pronounced and strain-dependent, suggesting an alternate acquisition  
683 or biosynthesis of IMP *in vivo* (McFarland and Stocker 1987), which was previously observed  
684 in *B. anthracis* (Ivánovics et al. 1968). A subsequent study on *E. coli* and *S. enterica*  
685 uncovered that almost all proteins involved in purine and pyrimidine biosynthesis were  
686 required for serum survival (Samant et al. 2008). In the same study, the role of PurE, PurK,  
687 CarA and PyrC was investigated in *B. anthracis* vaccine strain Sterne. Interestingly, PurE and  
688 PurK were required for bacterial survival in serum but only PurE promoted systemic infection.  
689 It was hypothesized that a non-enzymatic reaction at high concentration of bicarbonate could  
690 rescue the absence of PurK. *B. anthracis* PurH was later shown to be required for full  
691 virulence in guinea pigs but not in other animal infection models (Jenkins et al. 2011).

692 Using random transposon mutagenesis coupled with sequencing, *de novo* biosynthesis  
693 genes previously reported in non-pathogenic *E. coli* (Samant et al. 2008) were identified in  
694 ExPEC grown in swine serum, and loss of virulence of PurF and PyrF mutants was confirmed  
695 in a mouse model of infection (Ma et al. 2021). New screens mostly based on transposon  
696 mutagenesis (see box 2 and Supplementary Table 11) further highlighted requirement of  
697 nucleotide biosynthetic pathways for bacterial survival in blood or *in vivo* for other bacteria  
698 such as in several *Streptococcus* species (Polissi et al. 1998; Le Breton et al. 2013; Hooven  
699 et al. 2018; Charbonneau et al. 2020; Zhu et al. 2020, 2021), *Y. pseudotuberculosis*  
700 (Crimmins et al. 2012), *Y. pestis* (Palace et al. 2014), *N. meningitidis* (Sun et al. 2000;  
701 Mendum et al. 2011; Capel et al. 2017), *P. multocida* (Fuller et al. 2000), *P. mirabilis*  
702 (Armbruster et al. 2019), *S. aureus* (Benton et al. 2004; Christiansen et al. 2014; Connolly et  
703 al. 2017; Groma et al. 2020), *K. pneumoniae* (Weber et al. 2020) or *E. faecium* (Zhang et al.  
704 2017). By combining Tn-Seq with RNA-Seq this latter study pointed out upregulation of  
705 expression of the purine biosynthesis operon during bacterial growth in serum.

706 Taken together, these studies highlight the importance of *de novo* biosynthesis of purine  
707 and pyrimidine for successful bloodstream infection by a large panel of bacteria, presumably  
708 due to low abundance of these molecules in blood. Yet, purin synthesis inactivation was  
709 recently shown to enhance complement tolerance in *P. aeruginosa* (see section 'Complement

710 inhibitors'), emphasizing the need to investigate further the role of purin metabolism during  
711 infection (Janet-Maitre *et al.* 2023).

712

### 713 **Amino acid metabolism**

714 Similar to nucleotide auxotrophy, amino acid (AA) auxotrophy was linked to systemic  
715 infection several decades ago in *S. enterica* (Bacon *et al.* 1950, 1951). More recent studies,  
716 including genome-wide screens, identified bacterial factors involved in biosynthesis or import  
717 of amino acid during bacteremia (Supplementary Table 12). The shikimate pathway,  
718 responsible for aromatic compound biosynthesis, was targeted via *aroA* and *aroB* mutations  
719 to reduce the virulence of *S. enterica* (Hoiseth and Stocker 1981; McFarland and Stocker  
720 1987; Günel-Özcan *et al.* 1997; Chaudhuri *et al.* 2009). Virulence of shikimate deficient  
721 mutants was so attenuated that they have been used as vaccine candidates against typhoid  
722 fever. Further studies showed that this phenotype could be due to a membrane defect in  
723 addition to aromatic compound auxotrophy (Sebkova *et al.* 2008). The shikimate pathway has  
724 been shown to be involved in bacteremia for multiple bacteria, such as *K. pneumoniae*  
725 (Bachman *et al.* 2015; Weber *et al.* 2020), *L. monocytogenes* (Stritzker *et al.* 2004), *S. aureus*  
726 (Christiansen *et al.* 2014), several *Streptococcus* species (Hooven *et al.* 2018; Zhu *et al.* 2020),  
727 *P. mirabilis* (Armbruster *et al.* 2019), and *N. meningitidis* (Sun *et al.* 2000; Mendum *et al.*  
728 2011; Capel *et al.* 2017). The amino acid importer AroP was also shown to be required for  
729 optimal systemic infection with *Y. pestis* (Palace *et al.* 2014). Downstream of the shikimate  
730 pathway, tryptophan biosynthesis enzymes have been demonstrated as essential for  
731 bacterial survival during systemic infection by *S. aureus* (Mei *et al.* 1997; Coulter *et al.* 1998),  
732 *N. meningitidis* (Mendum *et al.* 2011; Capel *et al.* 2017) and *Y. pseudotuberculosis* (Crimmins  
733 *et al.* 2012). Thus, aromatic compounds seem to be restricted in the bloodstream, and their  
734 biosynthesis and/or uptake represent conserved traits of bacteria causing bloodstream  
735 infection. Branched-chain amino acids (BCAA), consisting in leucine, isoleucine and valine,  
736 were recently described as important for successful systemic infection of several pathogens  
737 such as *B. anthracis* (Dutta *et al.* 2022) and *S. aureus* (Kaiser *et al.* 2015). The link between

738 BCAA adaptive response to nutrient fluctuations and regulation of virulence has recently been  
739 reviewed (Kaiser and Heinrichs 2018). Various other amino acid metabolic pathways have  
740 been shown to be required for successful bloodstream infection. It is well illustrated by the  
741 study of *S. aureus* aspartate semialdehyde dehydrogenase Asd, an enzyme required for  
742 biosynthesis of lysine, methionine and threonine from aspartate. An Asd-defective mutant, as  
743 well as MetE-, ThrC- and LysA-defective mutants, auxotrophs for methionine, threonine and  
744 lysine respectively, showed reduced growth in calf serum (Oogai *et al.* 2016). Methionine  
745 requirement in blood was also shown by the decreased bacterial survival of methionine  
746 transporter deficient strains of *S. agalactiae* (Zhu *et al.* 2020) or *Y. pestis* (Palace *et al.* 2014),  
747 and methionine biosynthesis mutants of *N. meningitidis* (Sun *et al.* 2000; Capel *et al.* 2017).  
748 Other amino acid-related proteins identified in genome-wide mutational screens in conditions  
749 mimicking bacteremia are listed in Supplementary Table 12.

750 The arginine-derived polyamine (putrescine and spermidine) importer PotABCD was  
751 shown to be required for pneumococcal septicemia (Polissi *et al.* 1998; Ware *et al.* 2006).  
752 The Pot operon and the putrescine biosynthesis enzyme SpeA were found to be required for  
753 bloodstream survival in genome-wide mutational screens of *S. aureus* (Groma *et al.* 2020)  
754 and *P. mirabilis* (Armbruster *et al.* 2019), respectively. In a mouse model of typhoid fever,  
755 polyamines have been shown to be required for expression of *S. enterica* virulence factors  
756 and optimal infection (Jelsbak *et al.* 2012).

757 A particular mechanism used by *B. anthracis* to acquire essential amino acids from the  
758 host is to proteolyze human hemoglobin, enhancing its growth. This property is mediated by  
759 the secreted metalloprotease InhA1 and extends to other serum proteins, including albumin  
760 (Terwilliger *et al.* 2015).

761

## 762 **Carbon metabolism**

763 Carbon metabolism is one of the most fundamental functions in any living organism.  
764 Bacteria need to adapt to carbon sources available in the host during infection, in particular  
765 in blood (Supplementary Table 13).

766

767 Bacteria acquire carbon from carbohydrate sources available in their environment. They  
768 heavily rely on phosphoenolpyruvate-dependent phosphotransferase systems (PTS) which  
769 import and phosphorylate carbohydrates. PTS-related proteins important in virulence have  
770 been identified in *E. faecium* (Zhang *et al.* 2017), *Y. pestis* (Palace *et al.* 2014) and *N.*  
771 *meningitidis* (Sun *et al.* 2000; Capel *et al.* 2017). Surprisingly, the *N. meningitidis* PTS system  
772 is incomplete and should not be able to mediate import of carbohydrates. Its contribution to  
773 infection could rely on the pleiotropic role of the phosphocarrier protein Hpr during interactions  
774 with the host, in particular in blood (Antunes *et al.* 2016a). Mannose- and fructose-specific  
775 PTS systems are also required for bloodstream infection with *E. faecium* (Zhang *et al.* 2017)  
776 and *S. pyogenes* (Le Breton *et al.* 2013; Valdes *et al.* 2016), highlighting the importance of  
777 these specific sugars in blood. Interestingly, growth defect of *S. pyogenes fruR* and *fruB*  
778 deletion mutants was observed in human blood and not in mouse blood nor in infected mice,  
779 suggesting that fructose PTS are important for *S. pyogenes* survival in a human-specific  
780 environment (Valdes *et al.* 2016).

781 Bacteria can also import carbohydrates via ABC transporters or permeases. The non-  
782 PTS importer GlcU is required for optimal growth of *S. pyogenes* in blood. While the PtsI-  
783 dependent pathway plays a more important role in this phenotype, PTS-dependent and PTS-  
784 independent pathways are linked by an unknown mechanism (Sundar *et al.* 2018).  
785 Additionally, ExPEC relies on ribose import for its metabolism during bacteremia, but only a  
786 double mutant affected in the ribose transporter RbsDACB and in the citrate fermentation  
787 system CitCEFXG showed reduced fitness in blood and reduced virulence in infected mice,  
788 suggesting a pathway redundancy to support metabolic requirement during infection (Ma *et*  
789 *al.* 2020). In *N. meningitidis* the lactate permease LctP is required for resistance to  
790 complement (see section 'Complement inhibitors') and bloodstream infection. Interestingly,  
791 virulence attenuation of LctP deficient bacteria is mediated through the sialic acid  
792 biosynthesis pathway, connecting central carbon metabolism and virulence (Exley *et al.*  
793 2005).

794

795 Following import of carbon sources from their environment, bacteria use several  
796 pathways such as glycolysis, citrate cycle or the pentose-phosphate pathway to metabolize  
797 carbohydrates. These pathways produce energy and synthesize metabolites that directly  
798 impact pathogenesis.

799 For example, in addition to the lactate-dependent sialic acid biosynthesis by *N.*  
800 *meningitidis* associated to virulence described above, production of the capsule associated  
801 to *S. marcescens* virulence relies on phosphoglucomutase Pgm that converts glucose to  
802 pyruvate. A Pgm-deficient mutant in *S. enterica* could not use galactose as a carbon source,  
803 and showed a defect in LPS biosynthesis as well as virulence attenuation in mice (Chaudhuri  
804 *et al.* 2009; Paterson *et al.* 2009). Interestingly, galactose metabolism proteins GalE and GalU  
805 have been shown to be required for bacterial resistance to serum and systemic infection (Sun  
806 *et al.* 2000; Geoffroy *et al.* 2003; Phan *et al.* 2013; Zou *et al.* 2013; Capel *et al.* 2017), which  
807 could be due to their contribution to LPS biosynthesis (Robertson *et al.* 1993; Priebe *et al.*  
808 2004). Similarly, the fermentative *S. pneumoniae* requires lactate dehydrogenase Ldh to grow  
809 on glucose, survive in blood and promote virulence in mice, possibly through regulation of  
810 capsule production (Gaspar *et al.* 2014). In addition, *P. mirabilis* utilizes D-serine as a carbon  
811 source during bacteremia upon degradation, which involves DsdA, DsdC and DsdX proteins,  
812 (Brauer *et al.* 2019).

813 Carbon metabolic pathways required for successful bloodstream infection are thus  
814 diverse. Other examples are available in Supplementary Table 13.

815

### 816 **Other metabolic pathways**

817 Other metabolic pathways have been found to be required for bacterial survival in blood  
818 and/or bloodstream infection using several screens in conditions mimicking bacteremia  
819 (Supplementary Table 14).

820 **Electron transport chain.** Several electron transport chain genes have been shown to  
821 be required for bacterial survival in blood and virulence. For example, simultaneous deletion



822 of *hybABCD* and *hycEFG*, encoding the Ni-Fe hydrogenases 2 and 3 involved in anaerobic  
823 respiratory chains, impairs ExPEC growth in swine blood and in mice (Ma *et al.* 2020). Other  
824 electron transport chain components were identified in screens performed in *N. meningitidis*  
825 (Capel *et al.* 2017) and *S. enterica* (Chaudhuri *et al.* 2009). However, these studies lacked  
826 mechanistic aspects. Conversely, as reported in the section 'Resistance to phagocyte  
827 defenses', the electron transport chain sensitized *S. aureus* and *E. faecalis* to neutrophil  
828 oxidative burst, and its inactivation led to a greater survival in blood (Painter *et al.* 2017).

829 **Nitrogen metabolism.** Nitrogen is critical for production of amino acids and nucleic  
830 acids. Nitrogen assimilation proteins GlnA/GltB, GdhA and NtrB have been shown to be  
831 essential for nitrogen acquisition from blood during *P. mirabilis* infection (Armbruster *et al.*  
832 2019). Interestingly, orthologous proteins were also identified in other screens of bacterial  
833 factors required for survival in blood or *in vivo*, e.g. *S. suis* GlnA (Arenas *et al.* 2020), *E. coli*  
834 GltB (McCarthy, Stabler and Taylor 2018) or *N. meningitidis* GdhA (Capel *et al.* 2017). Further  
835 studies will be required to better discriminate the relative contribution of these factors to ROS  
836 resistance (see section 'Resistance to phagocyte defenses') and nitrogen uptake during  
837 bacteremia.

838 **Sulfur metabolism.** As an essential element for life, sulfur needs to be acquired by  
839 bacteria from environmental sources such as the abundant cysteine amino acid or its oxidized  
840 derivative cystine. It was first observed that the *L. monocytogenes* cysteine importer CtaP  
841 was required for systemic virulence, but the pleiotropic effects of its inactivation prevented  
842 from drawing any conclusion concerning cysteine requirement (Xayarath *et al.* 2009).  
843 Interestingly, proteins involved in cysteine transport (CysA, CysW, CysT) and sulfur  
844 metabolism were recently identified as necessary for *N. meningitidis* survival in the  
845 bloodstream (Capel *et al.* 2017). Additionally, cysteine/glutathione importer genes *cydCD*  
846 were shown to be required for efficient proliferation of *Y. pestis* during systemic infection  
847 (Palace *et al.* 2014). In *S. aureus*, regulation of cysteine metabolism plays a central role in  
848 stress resistance, host adaptation and virulence (Soutourina *et al.* 2010) and a recent study  
849 uncovered the importance of cystine importers TcyP and TcyABC during systemic infection

850 (Lensmire *et al.* 2020). This study concluded that sulfur salvage from host cystine could  
851 promote infection, which opens new perspectives on sulfur metabolism at the host-pathogen  
852 interface during bacteremia.

853 **Thiamine metabolism.** Thiamine (vitamin B1) is an essential co-factor for aerobic  
854 metabolism. Thiamine has been shown to be important for *L. monocytogenes* intracellular  
855 lifestyle (Schauer *et al.* 2009), and more recently for *P. aeruginosa* pulmonary infection, as  
856 well as being considered a promising target for antimicrobial development (Kim *et al.* 2020).  
857 Interestingly, thiamine-related genes were identified in several screens to discover factors  
858 involved in bacteremia in various bacteria such as *Y. pestis* (Palace *et al.* 2014), *S. sanguinis*  
859 (Zhu *et al.* 2021), *E. faecium* (Zhang *et al.* 2017), *N. meningitidis* (Capel *et al.* 2017), *P.*  
860 *mirabilis* (Armbruster *et al.* 2019) and *E. coli* (McCarthy, Stabler and Taylor 2018). However,  
861 their precise role during bloodstream infection remains to be addressed.

862 **Biotin metabolism.** Interestingly, while most *in vivo* screens had not identified any biotin-  
863 related genes necessary for infection, a recent study highlighted the difference of biotin levels  
864 between mice and human blood. In a mouse model mimicking human biotin levels, *A.*  
865 *baumannii*, *K. pneumoniae* and *P. aeruginosa* required a biotin biosynthetic pathway for  
866 infection (Carfrae *et al.* 2019). The role of biotin metabolism was confirmed in a screen  
867 investigating *K. pneumoniae* growth in human plasma (Weber *et al.* 2020). These studies  
868 pave the way to new antimicrobial treatments targeting biotin biosynthesis. On the other hand,  
869 a recent study suggested that biotin synthesis inactivation in *P. aeruginosa* leads to an  
870 enhanced complement resistance (see section 'Complement inhibitors'), highlighting the  
871 necessity to investigate further the role of biotin metabolism during bloodstream infection  
872 (Janet-Maitre *et al.* 2023).

## 873 **Bacterial factors mediating adaptive response to blood**

874 Bacteria developed multiple systems for environmental sensing and adaptation. To  
875 survive and replicate in the bloodstream, bacteria rely on regulatory mechanisms such as  
876 two-component systems, phase variation, small regulatory RNAs, thermosensors, and the  
877 stringent response. These mechanisms can promote infection by regulating factors previously  
878 described in this review (Figure 8).

879

### 880 **Two-component systems and phosphorelays**

881 Two-component systems (TCSs) play an important role in sensing the environment that  
882 bacteria face during the infection process. TCSs are generally composed of a sensor histidine  
883 kinase (SHK) anchored to bacterial surface and a SHK activated-response regulator that acts  
884 as a transcriptional activator or repressor of target genes (Jacob-Dubuisson *et al.* 2018).  
885 Phosphorelays are a variation of TCSs (Hoch 2000) that differ by having a more complex  
886 signal transduction pathway, using additional regulator and phosphotransferase domains. As  
887 bacteria reach the bloodstream, they sense signals to adapt rapidly to this environment by  
888 deploying mechanisms to subvert the different components of the immune response and  
889 adapt their metabolism. In particular, TCSs activate expression of virulence factors important  
890 for immune evasion and modulation of biosynthetic pathways (Supplementary Table 15).

891 **Phagocyte subversion.** TCSs allow to sense intracellular environment when bacteria  
892 are phagocytosed and trigger a transcriptional program to adapt to the intracellular lifestyle. For  
893 example, AgrAC promotes *S. aureus* dissemination in a model of systemic infection by  
894 manipulation of the autophagic flux, which could be mediated by the small cytotoxic alpha-  
895 helical peptides phenol-soluble modulins (PSMs) (O’Keeffe *et al.* 2015). Interestingly, human  
896 serum components, such as apolipoprotein B, downregulate the *agr* operon by sequestering  
897 the auto-inducing peptide, which is the trigger of the *agr* quorum sensing circuit. The  
898 constitutive expression of the AgrC sensor could overcome this immune response, and  
899 naturally occurring mutants in *agrAC* selected by immune pressure could lead to hypervirulent

900 strains (James, Edwards and Wigneshweraraj 2013). Furthermore, to resist to oxidative  
901 stress that occurs intra- or extracellularly, the AirSR TCS regulates staphyloxanthin  
902 production, which provides antioxidant properties to *S. aureus* and promotes bacterial survival  
903 in human blood (Hall *et al.* 2017). Likewise, *P. aeruginosa* superoxide response regulator of  
904 the SoxRS TCS is required for resistance to killing mediated by macrophages and systemic  
905 infection in a burned mouse model, suggesting protection against oxidative stress (Ha and  
906 Jin 1999).

907 Another regulatory mechanism based on phosphorylation is mediated by eukaryotic-like  
908 serine/threonine kinases, such as Stk1 in *S. agalactiae* which positively regulates expression  
909 of  $\beta$ -haemolysin  $\beta$ -H/C, enhancing resistance to neutrophils and oxidative stress, and  
910 possibly expression of the response regulator of the virulence TCS CoyRS (see below)  
911 (Rajagopal *et al.* 2006). One of the best characterized intracellular virulence system is the *S.*  
912 *enterica* pathogenicity island-2 (SPI-2), its second T3SS. SPI-2 is subjected to a complex  
913 regulation. It is primarily activated by the SsrAB TCS (originally known as SpiR/SsrB) located  
914 on SPI-2 (Fass and Groisman 2009). SsrAB itself is regulated by other TCSs involved in SPI-  
915 2 expression, such as OmpR/EnvZ (Dorman *et al.* 1989; Lee, Detweiler and Falkow 2000)  
916 and PhoPQ (Miller *et al.* 1989; Groisman *et al.* 1992; Groisman, Duprey and Choi 2021),  
917 promoting infection. Interestingly, inactivation of the TCS kinase PmrA induced a  
918 hypervirulent phenotype and the PmrAB TCS repressed SsrAB and SPI-2, which could be a  
919 mechanism to induce bacterial persistence (Choi and Groisman 2013). PhoPQ TCS is  
920 required for *S. enterica* virulence. It is sensing surface disturbances triggered for example by  
921 low  $Mg^{2+}$  concentration, acidic pH or AMP encountered intracellularly. PhoPQ regulates SPI-  
922 2,  $Mg^{2+}$  transport and MgtC-mediated acid resistance, and surface modification promoting  
923 resistance to AMP when entering phagolysosomes (Groisman, Duprey and Choi 2021).  
924 Interestingly, it was recently reported that the horizontally transferred gene *ssrB* regulates the  
925 ancestral PhoPQ, by helping to sense acidic pH through UgtL, thereby promoting infection  
926 (Choi and Groisman 2017, 2020; Groisman, Duprey and Choi 2021). Similarly to *S. enterica*

927 PhoPQ, *N. meningitidis* serogroup C PhoPQ promotes resistance to human defensin HNP-1  
928 and polymyxin B, bacterial survival in mouse but not human serum, and virulence in mouse  
929 model of meningococcal infection (Johnson *et al.* 2001; Newcombe *et al.* 2004). In *N.*  
930 *meningitidis* serogroup B, PhoPQ orthologous TCS MisRS, is up-regulated upon exposure to  
931 human blood (Echenique-Rivera *et al.* 2011). MisRS promotes resistance to oxidative stress,  
932 but decreases capsule production and resistance to bactericidal activity in human serum  
933 (Tzeng *et al.* 2008).

934 **Envelope modification and complement subversion.** TCS are widely used to regulate  
935 surface modification at the host-pathogen interface, reinforcing the envelope and promoting  
936 evasion from complement killing.

937 Capsule or extracellular polysaccharide (EPS) production is often controlled by TCSs,  
938 such as *S. pneumoniae* ZmpRS, linking carbon metabolism, capsule production and infection  
939 (Hirschmann *et al.* 2021a, 2021b). Other examples are *A. baumannii* BfmRS involved in  
940 production of capsular EPS upon bacterial exposure to low concentrations of antibiotics  
941 (Geisinger and Isberg 2015) and ExPEC TCS Rcs which controls EPS colanic acid production  
942 (Miajlovic and Smith 2014). Similar to TCS, eukaryotic-like serine/threonine kinase and  
943 phosphatase Stk and Stp1 of *S. suis* regulate capsule thickness and virulence factors  
944 promoting virulence (Liu *et al.* 2021). In *S. pyogenes*, CovRS regulates virulence factors  
945 involved in complement resistance in a strain-dependent manner (Sugareva *et al.* 2010).

946 LOS modification can also be regulated by TCSs. *H. influenzae* oxygen-dependent ArcAB  
947 TCS modulates expression of *lic2B*, a gene encoding a glycosyltransferase required for  
948 addition of a galactose residue to the outer core of LOS, promoting resistance to the  
949 complement classical pathway in serum and bacteremia in mice (De Souza-Hart *et al.* 2003;  
950 Wong *et al.* 2011). Interestingly, using genetic screens, ArcAB was also found to be required  
951 for bloodstream infection with *S. marcescens* (Anderson *et al.* 2017) and *C. freundii*  
952 (Anderson *et al.* 2018). These studies suggest a conserved role of this TCS in bacterial  
953 survival in blood. While LPS restructuring regulated by TCS such as PhoPQ or PmrAB has  
954 been described in *S. enterica* (Groisman *et al.* 2021), implication of these modifications in

955 bloodstream infection remains to be established.

956 TCSs also regulate proteins involved in complement subversion. For example, *P.*  
957 *aeruginosa* PhoPQ has been shown to downregulate the expression of OprH, a protein that  
958 binds complement factor C3, thus subverting opsonophagocytosis and promoting bacterial  
959 survival in blood and thereby infection (Qadi *et al.* 2017). Similarly, *S. mutans* VicRK TCS has  
960 been linked to the regulation of PepO, a peptidase also involved in reduction of C3b  
961 deposition and serum killing (Alves *et al.* 2017). In *S. aureus*, AirSR is necessary for  
962 expression of proteases SspA, SspB and SspC, cleaving C3 and allowing complement and  
963 phagocytosis escape (Hall *et al.* 2015). Lastly, *S. suis* WalRK TCS is involved in resistance  
964 to phagocytosis and virulence in mice, possibly by regulating expression of the gene encoding  
965 HP1065, a homolog of *S. pneumoniae* PspA, which plays a role in complement resistance  
966 (Pei *et al.* 2020). Surprisingly, while *Y. enterocolitica* OmpR/EnvZ regulates the complement  
967 resistance proteins Ail and OmpX, a strain lacking OmpR exhibits extremely high resistance  
968 to the bactericidal activity of serum. It has been proposed that OmpR could sensitize bacteria  
969 to complement killing by remodeling the outer membrane, altering the function of the major  
970 serum resistance factor YadA and the levels of the flagellar activator FlhDC (Skorek *et al.*  
971 2013).

972 **Coagulation.** Some bacteria use TCSs to regulate factors subverting the coagulation  
973 process. SaeRS, whose expression is upregulated upon *S. aureus* exposure to human blood  
974 (Malachowa *et al.* 2011), has been shown to contribute to bacterial survival in human blood  
975 and virulence in an *in vivo* model (Voyich *et al.* 2009). Conversely, a recent study reported  
976 that SaeRS regulates the coagulase Coa, a protein able to convert host prothrombin to  
977 staphylothrombin, leading to activation of the protease activity of thrombin and localized  
978 clotting detrimental to *S. aureus* survival in the bloodstream. This discrepancy has been  
979 hypothesized to be due to the variability in blood samples from different donors and/or  
980 differences in growth phase of bacteria inoculated (Guo *et al.* 2017). Another *S. aureus* TCS,  
981 ArIRS, has been shown to be involved in the regulation of agglutination during exposure to  
982 human plasma or fibrinogen and to affect the bacteremic phase of infection. This agglutination

983 phenotype is due to the negative regulation of the giant staphylococcal surface protein  
984 (GSSP) preventing fibrinogen binding and bacterial clumping (Walker *et al.* 2013). It was later  
985 shown that ArIRS promotes the expression of the redox-sensitive virulence regulator MgrA,  
986 enhancing leucocidin or capsule expression and decreasing GSSP and other surface protein  
987 expression (Crosby *et al.* 2016, 2020).

988

### 989 **Transcriptional regulators**

990 Transcriptional regulators (TRs) control gene expression, including that of virulence  
991 determinants (Balleza *et al.* 2009). Several transcriptional regulators playing a role in the  
992 bacteremic phase of infection have been identified (Supplementary Table 16). Major  
993 regulatory mechanisms are described below.

994 **Nutritional immunity.** Iron metabolism, involving iron transport and storage, is  
995 generally regulated by the repressor Fur or Fur homologues upon binding ferrous iron. The  
996 role of Fur in subversion of nutritional immunity in blood was identified in *N. meningitidis*  
997 (Echenique-Rivera *et al.* 2011) and in ExPEC (Huja *et al.* 2014; Ma *et al.* 2021). In *V.*  
998 *vulnificus* the global regulator Lrp positively regulates expression of genes involved in iron  
999 acquisition and secretion of the MARTX cytotoxin, promoting bacterial survival in serum and  
1000 cytotoxicity (Ho *et al.* 2017). In *S. pneumoniae* the iron-dependent transcriptional regulator  
1001 IDTR regulates transcription of several genes involved in virulence and iron metabolism, and  
1002 is required for full virulence in a mouse model of sepsis (Gupta *et al.* 2013).

1003 Similar to Fur, the manganese-cofactored MntR has been shown to be required for  
1004 systemic infection. In *S. aureus*, MntR regulates manganese homeostasis through the control  
1005 of MntABC transporter and MntE exporter (Grunenwald *et al.* 2019). *S. aureus* virulence also  
1006 relies on the LysR-type transcriptional regulator LTTR, which controls expression of the  
1007 copper detoxification transporter CopA (Groma *et al.* 2020).

1008 Interestingly, a new regulatory mechanism based on sensing amino acid content of  
1009 phagocytes was recently described. *S. enterica mgtCB* operon transcription, required for Mg<sup>2+</sup>  
1010 transport and resistance to acidic pH of the phagolysosome, relies on the upstream proline

1011 codon-rich *mgtP* sequence, which allows translation in absence of proline-charged tRNA<sup>Pro</sup>  
1012 in response to proline limitation (Lee et al. 2014).

1013 **Metabolism.** Regulation of amino acid and nucleotide metabolism is crucial for bacterial  
1014 proliferation in the bloodstream. *S. aureus* LTTR previously mentioned was recently shown  
1015 to be required for efficient colonization in a metastatic bloodstream infection model. LTTR  
1016 positively regulates amino acid biosynthesis and transport genes and decreases transcription  
1017 of genes involved in nucleotide biosynthesis and PTS transport (Groma *et al.* 2020).  
1018 Additionally, the master regulator of cysteine metabolism CymR also promotes *S. aureus*  
1019 survival in macrophages and in a mouse model of infection, presumably by regulating genes  
1020 involved in response to oxidative stress and metal ion homeostasis (Soutourina *et al.* 2010).  
1021 Furthermore, *S. agalactiae* MrvR, a transcription factor of the GntR family, controls the  
1022 expression of genes involved in nucleotide biosynthesis and salvage pathways and is  
1023 required for full virulence in a sepsis model (Dammann *et al.* 2021). The LysR family  
1024 transcriptional regulator CpsY is important for streptococcal fitness in blood, but its regulatory  
1025 effect on methionine metabolism depends on the species, preventing to draw a general  
1026 conclusion on its exact mode of action (Allen and Neely 2011; Le Breton *et al.* 2013).

1027 ExPEC FNR, involved in adaptation to anaerobic lifestyle and controlling central  
1028 metabolic processes, is required for survival in blood and infection (Ma *et al.* 2020, 2021),  
1029 highlighting the need of metabolic adaptation to survive and proliferate in the bloodstream.  
1030 Likewise, *N. meningitidis* HexR was identified as a repressor that can affect expression of  
1031 central carbon metabolism genes in presence of glucose and required to establish bacteremia  
1032 in an infant rat model (Antunes *et al.* 2016b). *S. pyogenes* RofA-like protein regulator type 3,  
1033 Ralp3, a central regulator of the ERES pathogenicity island, contributes to hyaluronic acid  
1034 capsule production and bacterial survival in human blood and serum. Comparative  
1035 transcriptomic analysis of wild type and *ralp3* mutant strains showed differential use of carbon  
1036 sources which could contribute to capsule synthesis, effects that were specific to serotypes  
1037 (Siemens *et al.* 2012). These examples highlight the importance of tight regulation of bacterial  
1038 metabolism to adapt and proliferate in the bloodstream.



1039           **Capsule, LPS and surface components regulation.** Surface components involved in  
1040 bloodstream infection, such as LPS or capsule, which allow resistance to complement, AMP  
1041 and phagocytes, are tightly controlled. For example, HyxA and HyxR are modulators of O-  
1042 antigen in UPEC (Phan *et al.* 2013) and presumably promote resistance to complement also  
1043 in ExPEC (Ma *et al.* 2021). Another regulatory mechanism is exemplified by RfaH  
1044 antiterminator that controls bacterial surface structure by regulating expression of operons  
1045 that direct biosynthesis, assembly, and export of LPS core components, pili, and capsule in  
1046 addition to toxins. This regulation promotes bacterial survival in blood in *E. coli* (McCarthy,  
1047 Stabler and Taylor 2018), *K. pneumoniae* (Bachman *et al.* 2015) and *V. vulnificus* (Garrett *et*  
1048 *al.* 2016). The latter study also highlights the role of RfaH-mediated phase variation for  
1049 capsule production. UPEC MrpA and LrhA also regulate capsule production, positively and  
1050 negatively, respectively, a mechanism which is conserved among different strains and  
1051 capsule types (Goh *et al.* 2017). A combination of gradient centrifugation and TRADIS  
1052 (TRADIsort) in *K. pneumoniae* also identified MprA as a capsule regulator (Dorman *et al.*  
1053 2018) necessary for serum survival (Bachman *et al.* 2015). KbvR is another capsule regulator  
1054 which also influences OMPs production and participates in *K. pneumoniae* resistance to  
1055 serum, AMPs and phagocytic killing, thus promoting systemic infection (Xu *et al.* 2021).

1056           Interestingly, *Y. pestis* fimbriae PsaA required for septicemic plague, is only produced at  
1057 37°C and at pH 6 (Lindler, Klempner and Straley 1990). The mechanism of its regulation by  
1058 the transcriptional regulator PsaE, also required for systemic infection, was recently  
1059 deciphered and consists in several layers of post-transcriptional and post-translational  
1060 regulation. An RNA thermosensor (see below) controls translation of both PsaE and PsaF, a  
1061 histidine-rich pH sensor stable at low pH. PsaF is required to prevent PsaE degradation,  
1062 which can in turn transcribe PsaA (Quinn *et al.* 2019; Li *et al.* 2021; Quinn *et al.* 2021).

1063           **Other virulence determinants.** Using *in vivo* induced antigen technology (IVIAT) in  
1064 convalescent-phase human serum, the transcriptional regulator HlyU was identified to be one  
1065 of the master regulators of *V. vulnificus* virulence. HlyU controls production of the  
1066 hemolysin/cytolysin VvhA and the elastolytic protease. The identification of *hlyU* by IVIAT

1067 suggests the importance of this gene in the bloodstream phase of infection (Kim *et al.* 2003).  
1068 Recently the virulence regulator Rsp has been shown to play a role in *S. aureus* transition  
1069 from the colonizing stage to the bacteremic stage. This regulator modulates activity of the  
1070 transcriptional regulator Agr, leading to opposite effects on bacterial survival in blood and  
1071 antibiotic susceptibility (Krishna *et al.* 2018).

1072 In *S. enterica*, expression of SPI-2 associated genes is regulated by the transcription  
1073 factor SlyA of the MarR family (Libby *et al.* 1994; Linehan *et al.* 2005; Yoon *et al.* 2009; Banda  
1074 *et al.* 2019), as well as IHF (HimD) and RpoE (Fass and Groisman 2009; Osborne and  
1075 Coombes 2009; Yoon *et al.* 2009). SlyA also induces expression of *ssrAB*, thereby promoting  
1076 virulence. Strikingly, RovA, the homologue of SlyA in *Yersinia* spp. plays a limited role in  
1077 systemic infection (Dube *et al.* 2003; Cathelyn *et al.* 2006), which could be explained by the  
1078 diversification of their respective regulons (Will *et al.* 2019).

1079

## 1080 **Phase variation**

1081 An additional mechanism of regulation of gene expression in bacteria is phase variation.  
1082 Phase variation refers to the mechanism by which bacteria regulate the expression of certain  
1083 groups of genes rapidly and in a reversible manner, either by on-off switching or by  
1084 modulating the expression of multiple allelic variants (Van Der Woude and Bäumlér 2004).  
1085 The presence of phase-variable genes allows to generate phenotypically diverse populations  
1086 of variants, some of which may be better suited to either colonize certain host niches, survive  
1087 in a particular environment and/or evade immune responses. Genes under phase-variable  
1088 control typically encode bacterial surface structures important for host adaptation such as  
1089 those playing a role in bloodstream infection, e.g. adhesins, pili, capsule and LOS  
1090 (Supplementary Table 17).

1091 **LPS/LOS.** An example of phase variation contributing to resistance to innate immune  
1092 response in the bloodstream is regulation of LOS modification by phosphorylcholine (PCho)  
1093 in *H. influenzae*. PCho is acquired from the host through the *lic* operon, which is controlled  
1094 by phase variation. It has been suggested that this mechanism decreases the amount of C3

1095 deposition on bacterial surface, thereby increasing survival in serum (Langereis *et al.* 2019).

1096 In *S. enterica* serovar Typhi, the O-antigen side chain of the LPS can be modified by the  
1097 activity of the glucosyltransferase *gtr* operons. The glucosylated form of the O-antigen  
1098 enhances bacterial survival in human serum by decreased complement binding. Expression  
1099 of the *gtrC* gene is controlled by epigenetic phase variation. It has been described that a  
1100 single nucleotide deviation from an epigenetic phase variation signature sequence leads to  
1101 uniform expression of the *gtr* operon in the population. (Broadbent *et al.* 2010).

1102 In *N. gonorrhoeae* the regulation of *lptA*, involved in phosphoethanolamine (PEA)  
1103 decoration of LOS lipid A, has been proposed to be under phase variation. High-frequency  
1104 mutations in a polynucleotide repeat within *lptA* can translate into a stop codon and  
1105 consequently an on/off switch, influencing gonococcal resistance to cationic antimicrobial  
1106 peptides (Kandler *et al.* 2014).

1107 **Capsule.** In *N. meningitidis*, the most frequent change in serogroup B strains is phase  
1108 variation of the gene *siaD*, which encodes the sialyl transferase involved in capsule synthesis.  
1109 Other genes in sialic acid biosynthesis or export of the capsule can be inactivated by  
1110 transposition of the insertion sequence IS1301 (Hammerschmidt *et al.* 1996). It has been later  
1111 shown in *N. meningitidis* serogroup C that the insertion of IS1301 into the *sia/ctr* intergenic  
1112 region leads to upregulation of capsule expression and enhanced resistance against  
1113 complement-mediated lysis. Insertion and excision of IS1301 into *siaA* causes phase-  
1114 variation of capsule biosynthesis that most likely occurs *in vivo* during bacteremia (Uria *et al.*  
1115 2008).

1116 In *S. pneumoniae* phase variation regulates capsule polysaccharide and teichoic acid  
1117 production. More capsular polysaccharide and less teichoic acid translate into increased  
1118 virulence. In this context, survival in the bloodstream may be promoted (Kim and Weiser  
1119 1998). Furthermore, modulation of the capsule in *S. pneumoniae* can be regulated by tandem  
1120 duplications within the *cap3A* gene of the type 3 capsule locus. The transition between the  
1121 off (duplication) and on (no-duplication) states depends on reversion of the duplication (Waite,  
1122 Struthers and Dowson 2001). Although this phase variation mechanism has not been

1123 demonstrated *in vivo*, it could play a role during the bacteremic phase of infection.

1124

## 1125 **Small RNAs**

1126 Small RNAs are ubiquitous regulators in the three domains of life. Bacteria employ small  
1127 RNAs ranging from 50 to 500 nucleotides for posttranscriptional regulation. These sRNAs  
1128 fold into diverse structures and act on gene targets with different molecular mechanisms. One  
1129 of the major mechanisms of sRNA-mediated regulation in bacteria is direct binding of the  
1130 sRNA via base pairing to a target mRNA. A single sRNA can play a central regulatory role in  
1131 controlling multiple gene targets leading to a global regulatory effect. Regulation mediated by  
1132 sRNA provides a fast mechanism for bacterial adaptation to environmental stress (Gottesman  
1133 and Storz 2011) (Supplementary Table 17).

1134 **Metabolism.** ArcAB TCS has been shown to downregulate expression of sRNA-17 to  
1135 promote *E. coli* K1 survival in blood and crossing of the blood-brain barrier. Functional  
1136 analysis using a bacteremia mouse model showed that sRNA-17 deletion promotes survival  
1137 in the blood, possibly by increasing the expression of genes involved in amino acid transport  
1138 and metabolism (Sun *et al.* 2020). In *N. meningitidis*, a tiling microarray analysis of bacteria  
1139 grown in human blood allowed identification of several differential expressed sRNAs. Four  
1140 sRNAs promoted bacteremia when tested in an infant rat model of bacteremia. One sRNA  
1141 designated Bns1 is linked to a GntR-like regulator and belongs to a network that responds to  
1142 carbon source availability and energy metabolism important for blood survival (Fagnocchi *et*  
1143 *al.* 2015). In *S. pneumoniae*, the F41 sRNA promotes survival in blood in a sepsis infection  
1144 model, which could be due to the regulation of a putative ABC transporter involved in  
1145 carbohydrate transport.

1146 **Capsule and surface components.** *S. pyogenes* Mga-activating regulatory sRNA  
1147 (MarS) positively regulates capsule production and the multiple virulence gene regulator *mga*,  
1148 controlling expression of the *emm* gene encoding the antiphagocytic protein M. Deletion of  
1149 this small RNA has been shown to decrease bacterial survival in human blood that could be  
1150 related to the lack of M protein and susceptibility to neutrophil clearance. Additionally, the

1151 *marS* mutant had reduced virulence in a mouse infection model. This sRNA is conserved in  
1152 many streptococci and could be a mechanism of gene regulation shared by different  
1153 *Streptococcus* species (Pappesch *et al.* 2017).

1154 **Coagulation.** *S. pyogenes* FasX sRNA negatively regulates the expression of pili and  
1155 positively regulates the thrombolytic agent streptokinase, in a serotype dependent manner.  
1156 Inactivation of FasX increases expression of pili and decreases expression of streptokinase  
1157 that catalyzes activation of human plasminogen into plasmin which can process several  
1158 enzymes to degrade blood clots and activate metalloproteinases and collagenases. FasX  
1159 promotes virulence in a bacteremia model of mice expressing human plasminogen (Danger  
1160 *et al.* 2015).

1161

## 1162 **Thermosensors**

1163 Thermosensors include bacterial DNA, RNA and proteins that can control gene  
1164 expression in response to changes in environmental temperature. Some RNA thermometers  
1165 (RNATs), which consist of RNA loops blocking access to the ribosome at low temperature  
1166 (Loh *et al.* 2018), have been shown to control gene expression of bacteria during the  
1167 bacteremic phase of infection (Supplementary Table 17).

1168 *N. meningitidis* regulates expression of the capsule gene *cssA*, the LPS sialylation gene  
1169 *Ist* and *fHbp* by RNATs. These three factors are important for evasion of immune killing and  
1170 contribute to proliferation in the bloodstream (Loh *et al.* 2013). A recent report based on  
1171 comparative analysis of the promoter regions of *fHbp* suggests that only some *fHbp* alleles  
1172 undergo thermoregulation and that the levels of expression of fHbp may be regulated by  
1173 variation in the coding sequence of the open reading frame (Spinsanti *et al.* 2021). Other  
1174 RNATs regulate expression of capsule and factor H binding proteins in *S. pneumoniae* and  
1175 *H. influenzae* (Eichner *et al.* 2021), thereby modulating resistance to complement.

1176 Another well-known thermo-regulated virulence factor is the T3SS of pathogenic *Yersinia*  
1177 species whose expression is induced at 37°C. It has been shown that the main T3SS  
1178 regulator LcrF is under the combined regulation of an RNAT in the 5' untranslated region

1179 (UTR) and of the thermolabile regulator YmoA (Böhme *et al.* 2012). LcrF is upregulated upon  
1180 *Y. pseudotuberculosis* incubation in human plasma (Rosso *et al.* 2008), but the effect of the  
1181 RNAT was only assessed in an intestinal infection model and would require further  
1182 investigation in a systemic infection model. The transcriptional regulator PsaE, regulating the  
1183 production of the *Y. pestis* PsaA fimbriae mentioned above, is also under control of an RNAT  
1184 (Quinn *et al.* 2019; Li *et al.* 2021).

1185 *S. enterica* TviA regulator is also under the control of an RNAT located in its 5' UTR. TviA  
1186 regulates virulence factors such as the Vi capsule, and its RNAT is required for innate immune  
1187 evasion (Brewer *et al.* 2021).

1188 While the first thermosensors were described 20 years ago and other reports identified  
1189 important virulence factors under control of RNATs, further studies are needed to gain a better  
1190 understanding of RNATs implication during bloodstream infection.

1191

## 1192 **Stringent response**

1193 Blood is a harsh environment challenging bacterial survival and triggering the stringent  
1194 response (SR) (Supplementary Table 17). Stringent response is defined by global changes  
1195 in bacterial gene expression associated with nutritional deprivation. The SR is triggered by  
1196 intracellular accumulation of two small, hyperphosphorylated GTP-/GDP-derived molecules,  
1197 namely, pppGpp and ppGpp, collectively designated (p)ppGpp or alarmones (Irving *et al.*  
1198 2020).

1199 **SR-regulated surface structures.** SR is generally mediated by (p)ppGpp synthetase  
1200 RelA and (p)ppGpp synthetase/hydrolase SpoT. Deletion of *relA* and *spoT* in *S. enterica*  
1201 serovar Typhi induces a (p)ppGpp<sub>0</sub> phenotype, and affects Vi capsule expression, resistance  
1202 to complement and survival in macrophages (Dasgupta *et al.* 2019). More recently, SpoT and  
1203 the nucleotide hydrolase PpnN target of SR were shown to change the structure of *S. enterica*  
1204 O-antigen and contribute to resistance to complement and survival in human serum (Chau *et*  
1205 *al.* 2021).

1206 In *E. coli* K1, expression of the (p)ppGpp activated sigma factor RpoE is significantly

1207 increased in the bloodstream and inactivation of this stress sigma factor leads to lower level  
1208 of bacteremia in a mouse model of infection. RpoE directly regulates expression of some  
1209 virulence genes such as *ompA*, *cnf1*, *fimB*, *ibeA*, and the capsule genes *kpsM*, and *kpsF*.  
1210 Also, RpoE indirectly modulates some virulence genes such as *fimA*, *aslA*, and *traJ* (Fan *et*  
1211 *al.* 2022). This example shows the broad impact of SR on regulation of virulence during  
1212 bacteremia.

1213 **Metabolic requirements for the SR.** The study of methicillin-resistant *S. aureus*  
1214 (MRSA) strains causing persistent or resolving bacteremia revealed a connection between  
1215 purine biosynthesis pathways and SR. MRSA strains causing persistent bacteremia had  
1216 significantly higher (p)ppGpp production, showed increased survival and induced higher lysis  
1217 of neutrophils, and expressed higher levels of phenol-soluble modulins Psm $\alpha$ 1–4. A *purF*  
1218 deletion mutant produced less GDP, GTP and consequently less (p)ppGpp, linking the purine  
1219 biosynthesis pathway to SR. Additionally, a mutant of *relP* encoding another alarmone  
1220 synthetase exhibits decreased Psm $\alpha$ 1–4 and Psm $\beta$ 1,2 expression, reduced neutrophil lysis  
1221 and decreased MRSA survival in neutrophils. Importantly, the *relP* gene has been  
1222 demonstrated to be necessary to overcome antibiotic treatment in persistent MRSA  
1223 bacteremia isolates (Li *et al.* 2020).

1224 These examples highlight the connection between SR and bacterial survival in blood and  
1225 the complexity of this adaptative mechanism. Recently, the importance of *A. baumannii* SpoT  
1226 during infection was uncovered by a proteomic analysis comparing bacterial infection of  
1227 macrophages in absence of presence of polymyxin B. This type of study emphasizes the  
1228 importance of deciphering the complex tripartite interactions between bacteria, their host, and  
1229 antibiotics to optimize the use of antimicrobials and develop innovative therapies against  
1230 multidrug-resistant pathogenic microorganisms (Kho *et al.* 2022).

## 1231 **Conclusion**

1232 Bacterial infection of the bloodstream is a serious threat that has become an important  
1233 global health issue in the context of antibiotic resistance. Characterization of mechanisms  
1234 involved in bacterial survival and proliferation in blood could help to develop alternative  
1235 therapeutic strategies. The genomic revolution has enabled us to explore these mechanisms  
1236 on a large scale, first with sequencing of bacterial genomes and later with functional  
1237 approaches based on transcriptomics, proteomics and transposon mutagenesis. Application  
1238 of functional genomics resulted in identification of a wealth of bacterial factors important for  
1239 survival in blood. In addition, combination of high-throughput approaches with relevant *ex*  
1240 *vivo* and *in vivo* experimental models led to a more comprehensive understanding of the  
1241 bacteremic phase of infectious diseases.

1242 An overview of research investigating pathogenesis of a broad-range of blood-borne  
1243 pathogenic bacteria highlights a striking conservation of host defense subversion  
1244 mechanisms, e.g. by targeting components of the complement pathways. Yet, other  
1245 mechanisms have been evolved specifically by specific species and even by specific strains  
1246 elucidating unique pathogenic properties of some clinical isolates. Bloodstream being a highly  
1247 complex and dynamic environment, the multiple regulatory mechanisms evolved by  
1248 pathogenic bacteria to evade host immunity and adapt to nutritional restrictions are  
1249 expectedly extremely complex systems whose activation signals and crosstalks remain to be  
1250 fully deciphered. Resistance to antibiotic treatment leading to development of subpopulations  
1251 of bacteria, such as evaders and persisters, adds another layer of complexity in the study of  
1252 host-pathogen interactions in bloodstream infections.

1253 Remarkable progress has been made in recent years toward an unprecedented  
1254 meticulous characterization of infection biology due to convergence of technologies such as  
1255 single-cell transcriptomics, dual proteomics, live cell imaging, tissue bioengineering, genome  
1256 editing and machine learning. Application of these innovative technologies to the study of  
1257 bloodstream infection will empower us to understand and predict highly complex host-



1258 pathogen interactions, and ultimately help design next-generation diagnostics, vaccines and  
1259 drugs in our post-antibiotic era.

1260

## 1261 **Acknowledgment**

1262 We are grateful to all members of the *Yersinia* Research Unit and the National Reference  
1263 Center *Yersinia* and other yersiniosis, WHO Collaborating Research and Reference Centre  
1264 for Plague FRA-140 for insightful discussions. We thank Cécile Schimmich for the help with  
1265 the bibliography. The *Yersinia* Research Unit is a member of the Laboratory of Excellence  
1266 Integrative Biology of Emerging Infectious Diseases (ANR-10-LBX-62-IBEID),

1267 This work was supported by Institut Pasteur, Université Paris Cité, CNRS, Agence de  
1268 l'Innovation de Défense (AID-DGA), Fondation pour la Recherche Médicale (FDT20220401-  
1269 5222), the Inception program (Investissement d'Avenir grant ANR-16-CONV-0005) and  
1270 Agence Nationale de la Recherche (ANR-21-CE39 0007 01). Funders had no role in study  
1271 design, data collection and interpretation, or the decision to submit the work for publication.  
1272 Figures were created with BioRender. We declare no conflict of interest.

1273

1274

ORIGINAL UNEDITED MANUSCRIPT

## 1275 **References**

- 1276 Abachin E, Poyart C, Pellegrini E *et al.* Formation of D-alanyl-lipoteichoic acid is required for  
1277 adhesion and virulence of *Listeria monocytogenes*. *Mol Microbiol* 2002;**43**:1–14.
- 1278 Abreu AG, Barbosa AS. How *Escherichia coli* circumvent complement-mediated killing. *Front*  
1279 *Immunol* 2017;**8**:452.
- 1280 Abreu AG, Fraga TR, Granados Martínez AP *et al.* The serine protease Pic from  
1281 enteroaggregative *Escherichia coli* mediates immune evasion by the direct cleavage of  
1282 complement proteins. *J Infect Dis* 2015;**212**:106–15.
- 1283 Allen JP, Neely MN. The *Streptococcus iniae* transcriptional regulator CpsY is required for  
1284 protection from neutrophil-mediated killing and proper growth *in vitro*. *Infect Immun*  
1285 2011;**79**:4638–48.
- 1286 Alonzo F, Benson MA, Chen J *et al.* *Staphylococcus aureus* leucocidin ED contributes to  
1287 systemic infection by targeting neutrophils and promoting bacterial growth *in vivo*. *Mol*  
1288 *Microbiol* 2012;**83**:423–35.
- 1289 Álvarez D, Merino S, Tomás JM *et al.* Capsular polysaccharide is a major complement  
1290 resistance factor in lipopolysaccharide O side chain-deficient *Klebsiella pneumoniae*  
1291 clinical isolates. *Infect Immun* 2000;**68**:953–5.
- 1292 Alves LA, Harth-Chu EN, Palma TH *et al.* The two-component system VicRK regulates  
1293 functions associated with *Streptococcus mutans* resistance to complement immunity. *Mol*  
1294 *Oral Microbiol* 2017;**32**:419–31.
- 1295 Ammendola S, Ajello M, Pasquali P *et al.* Differential contribution of *sodC1* and *sodC2* to  
1296 intracellular survival and pathogenicity of *Salmonella enterica* serovar Choleraesuis.  
1297 *Microbes Infect* 2005;**7**:698–707.
- 1298 Ammendola S, Pasquali P, Pistoia C *et al.* High-affinity Zn<sup>2+</sup> uptake system ZnuABC is required  
1299 for bacterial zinc homeostasis in intracellular environments and contributes to the  
1300 virulence of *Salmonella enterica*. *Infect Immun* 2007;**75**:5867.
- 1301 Anderson MT, Mitchell LA, Zhao L *et al.* Capsule production and glucose metabolism dictate

1302 fitness during *Serratia marcescens* bacteremia. *mBio* 2017;**8**:740–57.

1303 Anderson MT, Mitchell LA, Zhao L *et al.* *Citrobacter freundii* fitness during bloodstream  
1304 infection. *Sci Rep* 2018;**8**:11792.

1305 Antunes A, Derkaoui M, Terrade A *et al.* The phosphocarrier protein HPr contributes to  
1306 meningococcal survival during infection. *PLoS One* 2016a;**11**:e0162434.

1307 Antunes A, Golfieri G, Ferlicca F *et al.* HexR controls glucose-responsive genes and central  
1308 carbon metabolism in *Neisseria meningitidis*. *J Bacteriol* 2016b;**198**:644–54.

1309 Arenas J, Zomer A, Harders-Westerveen J *et al.* Identification of conditionally essential genes  
1310 for *Streptococcus suis* infection in pigs. *Virulence* 2020;**11**:446–64.

1311 Armbruster CE, Forsyth VS, Johnson AO *et al.* Twin arginine translocation, ammonia  
1312 incorporation, and polyamine biosynthesis are crucial for *Proteus mirabilis* fitness during  
1313 bloodstream infection. *PLoS Pathog* 2019;**15**:e1007653.

1314 Bachman MA, Breen P, Deornellas V *et al.* Genome-wide identification of *Klebsiella*  
1315 *pneumoniae* fitness genes during lung infection. *mBio* 2015;**6**:e00775.

1316 Bachman MA, Oyler JE, Burns SH *et al.* *Klebsiella pneumoniae* yersiniabactin promotes  
1317 respiratory tract infection through evasion of lipocalin 2. *Infect Immun* 2011;**79**:3309–16.

1318 Bacon GA, Burrows TW, Yates M. The effects of biochemical mutation on the virulence of  
1319 *Bacterium typhosum*: the virulence of mutants. *Br J Exp Pathol* 1950;**31**:714.

1320 Bacon GA, Burrows TW, Yates M. The effects of biochemical mutation on the virulence of  
1321 *Bacterium typhosum*: the loss of virulence of certain mutants. *Br J Exp Pathol* 1951;**32**:85.

1322 Bahar AA, Ren D. Antimicrobial peptides. *Pharmaceuticals* 2013;**6**:1543–75.

1323 Balleza E, López-Bojorquez LN, Martínez-Antonio A *et al.* Regulation by transcription factors  
1324 in bacteria: beyond description. *FEMS Microbiol Rev* 2009;**33**:133–51.

1325 Banda MM, Zavala-Alvarado C, Pérez-Morales D *et al.* SlyA and HilD counteract H-NS-  
1326 mediated repression on the *ssrAB* virulence operon of *Salmonella enterica* serovar  
1327 Typhimurium and thus promote its activation by OmpR. *J Bacteriol* 2019;**201**.

1328 Barbosa AS, Isaac L. Complement immune evasion by spirochetes. *Curr Top Microbiol*  
1329 *Immunol* 2018;**415**:215–38.

- 1330 Barnett AG, Page K, Campbell M *et al.* The increased risks of death and extra lengths of  
1331 hospital and ICU stay from hospital-acquired bloodstream infections: a case-control  
1332 study. *BMJ Open* 2013;**3**:e003587.
- 1333 Bartra SS, Ding Y, Fujimoto LM *et al.* *Yersinia pestis* uses the Ail outer membrane protein to  
1334 recruit vitronectin. *Microbiology (N Y)* 2015;**161**:2174.
- 1335 Bartra SS, Styer KL, O'Bryant DM *et al.* Resistance of *Yersinia pestis* to complement-  
1336 dependent killing is mediated by the Ail outer membrane protein. *Infect Immun*  
1337 2008;**76**:612–22.
- 1338 Bayle L, Chimalapati S, Schoehn G *et al.* Zinc uptake by *Streptococcus pneumoniae* depends  
1339 on both AdcA and AdcAll and is essential for normal bacterial morphology and virulence.  
1340 *Mol Microbiol* 2011;**82**:904–16.
- 1341 Bengoechea JA, Skurnik M. Temperature-regulated efflux pump/potassium antiporter system  
1342 mediates resistance to cationic antimicrobial peptides in *Yersinia*. *Mol Microbiol*  
1343 2000;**37**:67–80.
- 1344 Benton BM, Zhang JP, Bond S *et al.* Large-scale identification of genes required for full  
1345 virulence of *Staphylococcus aureus*. *J Bacteriol* 2004;**186**:8478.
- 1346 Bestebroer J, Aerts PC, Rooijackers SHM *et al.* Functional basis for complement evasion by  
1347 staphylococcal superantigen-like 7. *Cell Microbiol* 2010;**12**:1506–16.
- 1348 Bhatnagar SS. Phagocytosis of *B. typhosus* in relation to its antigenic structure and to the  
1349 antibody components of the sensitizing serum. *Br J Exp Pathol* 1935;**16**:375.
- 1350 Bidmos FA, Chan H, Praekelt U *et al.* Investigation into the antigenic properties and  
1351 contributions to growth in blood of the meningococcal haemoglobin receptors, HpuAB and  
1352 HmbR. Chang Y-F (ed.). *PLoS One* 2015;**10**:e0133855.
- 1353 Biedzka-Sarek M, Jarva H, Hyytiäinen H *et al.* Characterization of complement factor H binding  
1354 to *Yersinia enterocolitica* serotype O:3. *Infect Immun* 2008;**76**:4100–9.
- 1355 Bishai WR, Howard NS, Winkelstein JA *et al.* Characterization and virulence analysis of  
1356 catalase mutants of *Haemophilus influenzae*. *Infect Immun* 1994;**62**:4855–60.
- 1357 Bliska JB, Falkow S. Bacterial resistance to complement killing mediated by the Ail protein of

- 1358 *Yersinia enterocolitica*. *Proc Natl Acad Sci U S A* 1992;**89**:3561–5.
- 1359 Bobrov AG, Kirillina O, Fetherston JD *et al*. The *Yersinia pestis* siderophore, yersiniabactin,  
1360 and the ZnuABC system both contribute to zinc acquisition and the development of lethal  
1361 septicaemic plague in mice. *Mol Microbiol* 2014;**93**:759–75.
- 1362 Böhme K, Steinmann R, Kortmann J *et al*. Concerted actions of a thermo-labile regulator and  
1363 a unique intergenic RNA thermosensor control *Yersinia* virulence. *PLoS Pathog*  
1364 2012;**8**:e1002518.
- 1365 Bonten M, Johnson JR, Van Den Biggelaar AHJ *et al*. Epidemiology of *Escherichia coli*  
1366 bacteremia: a systematic literature review. *Clinical Infectious Diseases* 2021;**72**:1211–9.
- 1367 Boyer E, Bergevin I, Malo D *et al*. Acquisition of Mn(II) in addition to Fe(II) is required for full  
1368 virulence of *Salmonella enterica* serovar *Typhimurium*. *Infect Immun* 2002;**70**:6032–42.
- 1369 Brauer AL, White AN, Learman BS *et al*. d-Serine degradation by *Proteus mirabilis* contributes  
1370 to fitness during single-species and polymicrobial catheter-associated urinary tract  
1371 infection. *mSphere* 2019;**4**:e00020-19.
- 1372 Brekke OL, Hellerud BC, Christiansen D *et al*. *Neisseria meningitidis* and *Escherichia coli* are  
1373 protected from leukocyte phagocytosis by binding to erythrocyte complement receptor 1  
1374 in human blood. *Mol Immunol* 2011;**48**:2159–69.
- 1375 Le Breton Y, Mistry P, Valdes KM *et al*. Genome-wide identification of genes required for  
1376 fitness of group a *streptococcus* in human blood. *Infect Immun* 2013;**81**:862–75.
- 1377 Brewer SM, Twittenhoff C, Kortmann J *et al*. A *Salmonella Typhi* RNA thermosensor regulates  
1378 virulence factors and innate immune evasion in response to host temperature. *PLoS*  
1379 *Pathog* 2021;**17**:e1009345.
- 1380 Broadbent SE, Davies MR, Van Der Woude MW. Phase variation controls expression of  
1381 *Salmonella* lipopolysaccharide modification genes by a DNA methylation-dependent  
1382 mechanism. *Mol Microbiol* 2010;**77**:337–53.
- 1383 Brubaker RR. Interconversion of purine mononucleotides in *Pasteurella pestis*. *Infect Immun*  
1384 1970;**1**:446–54.
- 1385 Brunelli SM, Turenne W, Sibbel S *et al*. Clinical and economic burden of bloodstream infections

1386 in critical care patients with central venous catheters. *J Crit Care* 2016;**35**:69–74.

1387 Buchanan JT, Simpson AJ, Aziz RK *et al.* DNase expression allows the pathogen group A  
1388 *Streptococcus* to escape killing in neutrophil extracellular traps. *Current Biology*  
1389 2006;**16**:396–400.

1390 Cain AK, Barquist L, Goodman AL *et al.* A decade of advances in transposon-insertion  
1391 sequencing. *Nat Rev Genet* 2020;**21**:526–40.

1392 Calmettes C, Ing C, Buckwalter CM *et al.* The molecular mechanism of zinc acquisition by the  
1393 neisserial outer-membrane transporter ZnuD. *Nat Commun* 2015;**6**:7996.

1394 Capel E, Barnier JP, Zomer AL *et al.* Peripheral blood vessels are a niche for blood-borne  
1395 meningococci. *Virulence* 2017;**8**:1808–19.

1396 Carfrae LA, MacNair CR, Brown CM *et al.* Mimicking the human environment in mice reveals  
1397 that inhibiting biotin biosynthesis is effective against antibiotic-resistant pathogens. *Nat*  
1398 *Microbiol* 2019;**5**:93–101.

1399 Cathelyn JS, Crosby SD, Lathem WW *et al.* RovA, a global regulator of *Yersinia pestis*,  
1400 specifically required for bubonic plague. *Proc Natl Acad Sci U S A* 2006;**103**:13514–9.

1401 Cerasi M, Liu JZ, Ammendola S *et al.* The ZupT transporter plays an important role in zinc  
1402 homeostasis and contributes to *Salmonella enterica* virulence. *Metallomics* 2014;**6**:845–  
1403 53.

1404 Charbonneau ARL, Taylor E, Mitchell CJ *et al.* Identification of genes required for the fitness  
1405 of *Streptococcus equi* subsp. *equi* in whole equine blood and hydrogen peroxide. *Microb*  
1406 *Genom* 2020;**6**:e000362.

1407 Chau NYE, Pérez-Morales D, Elhenawy W *et al.* (p)ppGpp-dependent regulation of the  
1408 nucleotide hydrolase PpnN confers complement resistance in *Salmonella enterica*  
1409 serovar typhimurium. *Infect Immun* 2021;**89**.

1410 Chaudhuri RR, Peters SE, Pleasance SJ *et al.* Comprehensive identification of *Salmonella*  
1411 *enterica* serovar typhimurium genes required for infection of BALB/c mice. *PLoS Pathog*  
1412 2009;**5**:1000529.

1413 Chen KW, Brodsky IE. *Yersinia interactions with regulated cell death pathways.* *Curr Opin*

1414 *Microbiol* 2023;**71**:102256.

1415 Chen YC, Chuang YC, Chang CC *et al.* A K<sup>+</sup> uptake protein, TrkA, is required for serum,  
1416 protamine, and polymyxin B resistance in *Vibrio vulnificus*. *Infect Immun* 2004;**72**:629–  
1417 36.

1418 Choi E, Choi S, Nam D *et al.* Elongation factor P restricts *Salmonella*'s growth by controlling  
1419 translation of a Mg<sup>2+</sup> transporter gene during infection. *Sci Rep* 2017;**7**.

1420 Choi J, Groisman EA. The lipopolysaccharide modification regulator PmrA limits *Salmonella*  
1421 *virulence* by repressing the type three-secretion system Spi/Ssa. *Proc Natl Acad Sci U S*  
1422 *A* 2013;**110**:9499–504.

1423 Choi J, Groisman EA. Activation of master virulence regulator PhoP in acidic pH requires the  
1424 *Salmonella*-specific protein UgtL. *Sci Signal* 2017;**10**.

1425 Choi J, Groisman EA. Horizontally acquired regulatory gene activates ancestral regulatory  
1426 system to promote *Salmonella* virulence. *Nucleic Acids Res* 2020;**48**:10832.

1427 Christiansen MT, Kaas RS, Chaudhuri RR *et al.* Genome-wide high-throughput screening to  
1428 investigate essential genes involved in methicillin-resistant *Staphylococcus aureus*  
1429 sequence type 398 survival. *PLoS One* 2014;**9**:e89018.

1430 Collins LV, Kristian SA, Weidenmaier C *et al.* *Staphylococcus aureus* strains lacking d-Alanine  
1431 modifications of teichoic acids are highly susceptible to human neutrophil killing and are  
1432 virulence attenuated in mice. *J Infect Dis* 2002;**186**:214–9.

1433 Connolly J, Boldock E, Prince LR *et al.* Identification of *Staphylococcus aureus* factors required  
1434 for pathogenicity and growth in human blood. *Infect Immun* 2017;**85**:e00337-17.

1435 Cortes-Perez NG, Dumoulin R, Gaubert S *et al.* Overexpression of *Enterococcus faecalis* *elr*  
1436 operon protects from phagocytosis microbe-host interactions and microbial pathogenicity.  
1437 *BMC Microbiol* 2015;**15**:112.

1438 Coulter SN, Schwan WR, Ng EYW *et al.* *Staphylococcus aureus* genetic loci impacting growth  
1439 and survival in multiple infection environments. *Mol Microbiol* 1998;**30**:393–404.

1440 Coureuil M, Lécuyer H, Bourdoulous S *et al.* A journey into the brain: insight into how bacterial  
1441 pathogens cross blood-brain barriers. *Nat Rev Microbiol* 2017;**15**:149–159.

- 1442 Crimmins GT, Mohammadi S, Green ER *et al.* Identification of MrtAB, an ABC transporter  
1443 specifically required for *Yersinia pseudotuberculosis* to colonize the mesenteric lymph  
1444 nodes. *PLoS Pathog* 2012;**8**:e1002828.
- 1445 Crosby HA, Schlievert PM, Merriman JA *et al.* The *Staphylococcus aureus* global regulator  
1446 MgrA modulates clumping and virulence by controlling surface protein expression. *PLoS*  
1447 *Pathog* 2016;**12**:e1005604.
- 1448 Crosby HA, Tiwari N, Kwiecinski JM *et al.* The *Staphylococcus aureus* ArIRS two-component  
1449 system regulates virulence factor expression through MgrA. *Mol Microbiol* 2020;**113**:103–  
1450 22.
- 1451 Crump KE, Bainbridge B, Brusko S *et al.* The relationship of the lipoprotein SsaB, manganese  
1452 and superoxide dismutase in *Streptococcus sanguinis* virulence for endocarditis. *Mol*  
1453 *Microbiol* 2014;**92**:1243–59.
- 1454 Cunrath O, Bumann D. Host resistance factor SLC11A1 restricts *Salmonella* growth through  
1455 magnesium deprivation. *Science (1979)* 2019;**366**:995–9.
- 1456 Dahesh S, Nizet V, Cole JN. Study of streptococcal hemoprotein receptor (Shr) in iron  
1457 acquisition and virulence of M1T1 group A *Streptococcus*. *Virulence* 2012;**3**:566–75.
- 1458 Dalia AB, Standish AJ, Weiser JN. Three surface exoglycosidases from *Streptococcus*  
1459 *pneumoniae*, NanA, BgaA, and StrH, promote resistance to opsonophagocytic killing by  
1460 human neutrophils. *Infect Immun* 2010;**78**:2108–16.
- 1461 Dammann AN, Chamby AB, Catomeris AJ *et al.* Genome-wide fitness analysis of group B  
1462 *Streptococcus* in human amniotic fluid reveals a transcription factor that controls multiple  
1463 virulence traits. *PLoS Pathog* 2021;**17**:e1009116.
- 1464 Danger JL, Cao TN, Cao TH *et al.* The small regulatory RNA FasX enhances group A  
1465 *Streptococcus* virulence and inhibits pilus expression via serotype-specific targets. *Mol*  
1466 *Microbiol* 2015;**96**:249–62.
- 1467 Dasgupta S, Das S, Biswas A *et al.* Small alarmones (p)ppGpp regulate virulence associated  
1468 traits and pathogenesis of *Salmonella enterica* serovar Typhi. *Cell Microbiol*  
1469 2019;**21**:e13034.



- 1470 Deen J, von Seidlein L, Andersen F *et al.* Community-acquired bacterial bloodstream infections  
1471 in developing countries in south and southeast Asia: a systematic review. *Lancet Infect*  
1472 *Dis* 2012;**12**:480–7.
- 1473 Demeure CE, Dussurget O, Mas Fiol G *et al.* *Yersinia pestis* and plague: an updated view on  
1474 evolution, virulence determinants, immune subversion, vaccination, and diagnostics.  
1475 *Genes Immun* 2019;**20**:357–70.
- 1476 Devyatyarova-Johnson M, Rees IH, Robertson BD *et al.* The lipopolysaccharide structures of  
1477 *Salmonella enterica* serovar Typhimurium and *Neisseria gonorrhoeae* determine the  
1478 attachment of human mannose-binding lectin to intact organisms. *Infect Immun*  
1479 2000;**68**:3894–9.
- 1480 Diekema DJ, Hsueh PR, Mendes RE *et al.* The microbiology of bloodstream infection: 20-Year  
1481 trends from the SENTRY antimicrobial surveillance program. *Antimicrob Agents*  
1482 *Chemother* 2019;**63**:e00355-19.
- 1483 Doorduyn DJ, Rooijackers SHM, van Schaik W *et al.* Complement resistance mechanisms of  
1484 *Klebsiella pneumoniae*. *Immunobiology* 2016;**221**:1102–9.
- 1485 Dorman CJ, Chatfield S, Higgins CF *et al.* Characterization of porin and *ompR* mutants of a  
1486 virulent strain of *Salmonella typhimurium*: *ompR* mutants are attenuated *in vivo*. *Infect*  
1487 *Immun* 1989;**57**:2136–40.
- 1488 Dorman MJ, Feltwell T, Goulding DA *et al.* The capsule regulatory network of *Klebsiella*  
1489 *pneumoniae* defined by density-TraDISort. *mBio* 2018;**9**:e01863-18.
- 1490 Dube PH, Handley SA, Revell PA *et al.* The *rovA* mutant of *Yersinia enterocolitica* displays  
1491 differential degrees of virulence depending on the route of infection. *Infect Immun*  
1492 2003;**71**:3512–20.
- 1493 Dulipati V, Meri S, Panelius J. Complement evasion strategies of *Borrelia burgdorferi sensu*  
1494 *lato*. *FEBS Lett* 2020;**594**:2645–56.
- 1495 Dutta S, Corsi ID, Bier N *et al.* BrnQ-type branched-chain amino acid transporters influence  
1496 *Bacillus anthracis* growth and virulence. *mBio* 2022;**13**:e03640-21.
- 1497 Echenique-Rivera H, Muzzi A, Del Tordello E *et al.* Transcriptome analysis of *Neisseria*

1498 *meningitidis* in human whole blood and mutagenesis studies identify virulence factors  
1499 involved in blood survival. *PLoS Pathog* 2011;**7**.

1500 Eichner H, Karlsson J, Spelmink L *et al.* RNA thermosensors facilitate *Streptococcus*  
1501 *pneumoniae* and *Haemophilus influenzae* immune evasion. Mitchell TJ (ed.). *PLoS*  
1502 *Pathog* 2021;**17**:e1009513.

1503 Ermert D, Ram S, Laabei M. The hijackers guide to escaping complement: lessons learned  
1504 from pathogens. *Mol Immunol* 2019;**114**:49–61.

1505 Eshghi A, Lourdault K, Murray GL *et al.* *Leptospira interrogans* catalase is required for  
1506 resistance to H<sub>2</sub>O<sub>2</sub> and for virulence. *Infect Immun* 2012;**80**:3892–9.

1507 Exley RM, Shaw J, Mowe E *et al.* Available carbon source influences the resistance of  
1508 *Neisseria meningitidis* against complement. *Journal of Experimental Medicine*  
1509 2005;**201**:1637–45.

1510 Fagnocchi L, Bottini S, Golfieri G *et al.* Global transcriptome analysis reveals small RNAs  
1511 affecting *Neisseria meningitidis* bacteremia. *PLoS One* 2015;**10**:126325.

1512 Fan Y, Bai J, Xi D *et al.* RpoE facilitates stress-resistance, invasion, and pathogenicity of  
1513 *Escherichia coli* K1. *Microorganisms* 2022;**10**:879.

1514 Fang FC, Degroote MA, Foster JW *et al.* Virulent *Salmonella typhimurium* has two periplasmic  
1515 Cu, Zn-superoxide dismutases. *Proc Natl Acad Sci U S A* 1999;**96**:7502–7.

1516 Farrant JL, Sansone A, Canvin JR *et al.* Bacterial copper- and zinc-cofactored superoxide  
1517 dismutase contributes to the pathogenesis of systemic salmonellosis. *Mol Microbiol*  
1518 1997;**25**:785–96.

1519 Fass E, Groisman EA. Control of *Salmonella* pathogenicity island-2 gene expression. *Curr*  
1520 *Opin Microbiol* 2009;**12**:199.

1521 Felix A, Bhatnagar SS. Further observations on the properties of the Vi antigen of *B. typhosus*  
1522 and its corresponding antibody. *Br J Exp Pathol* 1935;**16**:422.

1523 Fenlon LA, Slauch JM. Cytoplasmic copper detoxification in *Salmonella* can contribute to SodC  
1524 metalation but is dispensable during systemic infection. *J Bacteriol* 2017;**199**.

1525 Ferreira VP, Pangburn MK, Cortés C. Complement control protein factor H: the good, the bad,

- 1526 and the inadequate. *Mol Immunol* 2010;**47**:2187–97.
- 1527 Fisher N, Shetron-Rama L, Herring-Palmer A *et al*. The *dltABCD* operon of *Bacillus anthracis*  
1528 Sterne is required for virulence and resistance to peptide, enzymatic, and cellular  
1529 mediators of innate immunity. *J Bacteriol* 2006;**188**:1301–9.
- 1530 Fittipaldi N, Sekizaki T, Takamatsu D *et al*. D-alanylation of lipoteichoic acid contributes to the  
1531 virulence of *Streptococcus suis*. *Infect Immun* 2008;**76**:3587–94.
- 1532 Fleischmann C, Scherag A, Adhikari NKJ *et al*. Assessment of global incidence and mortality  
1533 of hospital-treated sepsis. Current estimates and limitations. *Am J Respir Crit Care Med*  
1534 2016;**193**:259–72.
- 1535 Ford DC, Joshua GWP, Wren BW *et al*. The importance of the magnesium transporter MgtB  
1536 for virulence of *Yersinia pseudotuberculosis* and *Yersinia pestis*. *Microbiology (United*  
1537 *Kingdom)* 2014;**160**:2710–7.
- 1538 Formal SB, Baron LS, Spilman W. Studies on the virulence of a naturally occurring mutant of  
1539 *Salmonella typhosa*. *J Bacteriol* 1954;**68**:117–21.
- 1540 Francis MS, Thomas CJ. Mutants in the CtpA copper transporting P-type ATPase reduce  
1541 virulence of *Listeria monocytogenes*. *Microb Pathog* 1997;**22**:67–78.
- 1542 Fuller TE, Kennedy MJ, Lowery DE. Identification of *Pasteurella multocida* virulence genes in  
1543 a septicemic mouse model using signature-tagged mutagenesis. *Microb Pathog*  
1544 2000;**29**:25–38.
- 1545 Garber ED, Hackett AJ, Franklin R. The virulence of biochemical mutants of *Klebsiella*  
1546 *pneumoniae*. *Proc Natl Acad Sci U S A* 1952;**38**:693.
- 1547 Garrett SB, Garrison-Schilling KL, Cooke JT *et al*. Capsular polysaccharide production and  
1548 serum survival of *Vibrio vulnificus* are dependent on antitermination control by RfaH.  
1549 *FEBS Lett* 2016;**590**:4564–72.
- 1550 Gaspar P, Al-Bayati FAY, Andrew PW *et al*. Lactate dehydrogenase is the key enzyme for  
1551 pneumococcal pyruvate metabolism and pneumococcal survival in blood. *Infect Immun*  
1552 2014;**82**:5099–109.
- 1553 Geisinger E, Isberg RR. Antibiotic modulation of capsular exopolysaccharide and virulence in

1554 *Acinetobacter baumannii*. *PLoS Pathog* 2015;**11**:e1004691.

1555 Geoffroy MC, Floquet S, Métais A *et al*. Large-scale analysis of the meningococcus genome  
1556 by gene disruption: resistance to complement-mediated lysis. *Genome Res* 2003;**13**:391–  
1557 8.

1558 Giuntini S, Pajon R, Ram S *et al*. Binding of complement factor H to PorB3 and NspA enhances  
1559 resistance of *Neisseria meningitidis* to anti-factor H binding protein bactericidal activity.  
1560 *Infect Immun* 2015;**83**:1536–45.

1561 Goh KGK, Phan MD, Forde BM *et al*. Genome-wide discovery of genes required for capsule  
1562 production by uropathogenic *Escherichia coli*. *mBio* 2017;**8**:1558–75.

1563 González-Alsina A, Mateu-Borrás M, Doménech-Sánchez A *et al*. *Pseudomonas aeruginosa*  
1564 and the complement system: a review of the evasion strategies. *Microorganisms*  
1565 2023;**11**:664.

1566 Goto M, Al-Hasan MN. Overall burden of bloodstream infection and nosocomial bloodstream  
1567 infection in North America and Europe. *Clinical Microbiology and Infection* 2013;**19**:501–  
1568 9.

1569 Gottesman S, Storz G. Bacterial small RNA regulators: versatile roles and rapidly evolving  
1570 variations. *Cold Spring Harb Perspect Biol* 2011;**3**.

1571 Gowen JW, Stadler J, Plough HH *et al*. Virulence and immunizing capacity of *Salmonella*  
1572 *typhimurium* as related to mutations in metabolic requirements. *Genetics* 1953;**38**:531–  
1573 49.

1574 Grim KP, San Francisco B, Radin JN *et al*. The metallophore staphylopine enables  
1575 *Staphylococcus aureus* to compete with the host for zinc and overcome nutritional  
1576 immunity. *mBio* 2017;**8**.

1577 Groisman EA, Duprey A, Choi J. How the PhoP/PhoQ system controls virulence and Mg<sup>2+</sup>  
1578 homeostasis: lessons in signal transduction, pathogenesis, physiology, and evolution.  
1579 *Microbiology and Molecular Biology Reviews* 2021;**85**:e0017620.

1580 Groisman EA, Parra-Lopez C, Salcedo M *et al*. Resistance to host antimicrobial peptides is  
1581 necessary for *Salmonella* virulence. *Proceedings of the National Academy of Sciences*

1582 1992;**89**:11939–43.

1583 Groma M, Horst SA, Das S *et al.* Identification of a novel LysR-type transcriptional regulator in  
1584 *Staphylococcus aureus* that is crucial for secondary tissue colonization during metastatic  
1585 bloodstream infection. *mBio* 2020;**11**:e01646-20.

1586 De Groote MA, Ochsner UA, Shiloh MU *et al.* Periplasmic superoxide dismutase protects  
1587 *Salmonella* from products of phagocyte NADPH-oxidase and nitric oxide synthase. *Proc*  
1588 *Natl Acad Sci U S A* 1997;**94**:13997–4001.

1589 Grunenwald CM, Choby JE, Juttukonda LJ *et al.* Manganese detoxification by MntE is critical  
1590 for resistance to oxidative stress and virulence of *Staphylococcus aureus*. *mBio*  
1591 2019;**10**:e02915-18.

1592 Guiney DG, Fierer J. The role of the *spv* genes in *Salmonella* pathogenesis. *Front Microbiol*  
1593 2011;**2**:10768.

1594 Günel-Özcan A, Brown KA, Allen AG *et al.* *Salmonella typhimurium aroB* mutants are  
1595 attenuated in BALB/c mice. *Microb Pathog* 1997;**23**:311–6.

1596 Gunn JS, Ryan SS, Van Velkinburgh JC *et al.* Genetic and functional analysis of a PmrA-  
1597 PmrB-regulated locus necessary for lipopolysaccharide modification, antimicrobial  
1598 peptide resistance, and oral virulence of *Salmonella enterica* serovar Typhimurium. *Infect*  
1599 *Immun* 2000;**68**:6139–46.

1600 Guo H, Hall JW, Yang J *et al.* The SaeRS two-component system controls survival of  
1601 *Staphylococcus aureus* in human blood through regulation of coagulase. *Front Cell Infect*  
1602 *Microbiol* 2017;**7**:204.

1603 Gupta R, Bhatta M, Swiatlo E *et al.* Role of an iron-dependent transcriptional regulator in the  
1604 pathogenesis and host response to infection with *Streptococcus pneumoniae*. *PLoS One*  
1605 2013;**8**:e55157.

1606 Ha U, Jin S. Expression of the *soxR* gene of *Pseudomonas aeruginosa* is inducible during  
1607 infection of burn wounds in mice and is required to cause efficient bacteremia. *Infect*  
1608 *Immun* 1999;**67**:5324–31.

1609 De Haas CJC, Veldkamp KE, Peschel A *et al.* Chemotaxis inhibitory protein of *Staphylococcus*

1610 *aureus*, a bacterial antiinflammatory agent. *J Exp Med* 2004;**199**:687–95.

1611 De Haas CJC, Weeterings C, Vughs MM *et al.* Staphylococcal superantigen-like 5 activates  
1612 platelets and supports platelet adhesion under flow conditions, which involves  
1613 glycoprotein Iba and  $\alpha_{IIb}\beta_3$ . *Journal of Thrombosis and Haemostasis* 2009;**7**:1867–74.

1614 Hair PS, Ward MD, Semmes OJ *et al.* *Staphylococcus aureus* clumping factor A binds to  
1615 complement regulator factor I and increases factor I cleavage of C3b. *J Infect Dis*  
1616 2008;**198**:125–33.

1617 Hall JW, Yang J, Guo H *et al.* The AirSR two-component system contributes to *Staphylococcus*  
1618 *aureus* survival in human blood and transcriptionally regulates *sspABC* operon. *Front*  
1619 *Microbiol* 2015;**6**:682.

1620 Hall JW, Yang J, Guo H *et al.* The *Staphylococcus aureus* AirSR two-component system  
1621 mediates reactive oxygen species resistance via transcriptional regulation of  
1622 staphyloxanthin production. *Infect Immun* 2017;**85**:e00838-16.

1623 Hallström T, Uhde M, Singh B *et al.* *Pseudomonas aeruginosa* uses dihydrolipoamide  
1624 dehydrogenase (Lpd) to bind to the human terminal pathway regulators vitronectin and  
1625 clusterin to inhibit terminal pathway complement attack. *PLoS One* 2015;**10**:e0137630.

1626 Hammerschmidt S, Hilse R, Van Putten JPM *et al.* Modulation of cell surface sialic acid  
1627 expression in *Neisseria meningitidis* via a transposable genetic element. *EMBO J*  
1628 1996;**15**:192–8.

1629 Hankins J V., Madsen JA, Giles DK *et al.* Amino acid addition to *Vibrio cholerae* LPS  
1630 establishes a link between surface remodeling in Gram-positive and Gram-negative  
1631 bacteria. *Proc Natl Acad Sci U S A* 2012;**109**:8722–7.

1632 Hart PJ, O’Shaughnessy CM, Siggins MK *et al.* Differential killing of *Salmonella enterica*  
1633 serovar Typhi by antibodies targeting Vi and lipopolysaccharide O:9 antigen. *PLoS One*  
1634 2016;**11**:e0145945.

1635 Hattori H, Maeda M, Nagatomo Y *et al.* Epidemiology and risk factors for mortality in  
1636 bloodstream infections: a single-center retrospective study in Japan. *Am J Infect Control*  
1637 2018;**46**:e75–9.

- 1638 Hayashi M, Machida T, Ishida Y *et al.* Cutting edge: role of MASP-3 in the physiological  
1639 activation of factor D of the alternative complement pathway. *The Journal of Immunology*  
1640 2019;**203**:1411–6.
- 1641 Heffernan EJ, Reed S, Hackett J *et al.* Mechanism of resistance to complement-mediated  
1642 killing of bacteria encoded by the *Salmonella typhimurium* virulence plasmid gene *rck*. *J*  
1643 *Clin Invest* 1992;**90**:953–64.
- 1644 Hensel M, Shea JE, Gleeson C *et al.* Simultaneous identification of bacterial virulence genes  
1645 by negative selection. *Science (1979)* 1995;**269**:400–3.
- 1646 Herrera CM, Crofts AA, Henderson JC *et al.* The *Vibrio cholerae* VprA-VprB two-component  
1647 system controls virulence through endotoxin modification. *mBio* 2014;**5**:2283–97.
- 1648 Hesse LE, Lonergan ZR, Beavers WN *et al.* The *Acinetobacter baumannii* Znu system  
1649 overcomes host-imposed nutrient zinc limitation. Whiteley M (ed.). *Infect Immun* 2019;**87**.
- 1650 Higgins J, Loughman A, Van Kessel KPM *et al.* Clumping factor A of *Staphylococcus aureus*  
1651 inhibits phagocytosis by human polymorphonuclear leucocytes. *FEMS Microbiol Lett*  
1652 2006;**258**:290–6.
- 1653 Hirschmann S, Gómez-mejia A, Kohler TP *et al.* The two-component system 09 of  
1654 *Streptococcus pneumoniae* is important for metabolic fitness and resistance during  
1655 dissemination in the host. *Microorganisms* 2021a;**9**:1365.
- 1656 Hirschmann S, Gómez-Mejia A, Mäder U *et al.* The two-component system 09 regulates  
1657 pneumococcal carbohydrate metabolism and capsule expression. *Microorganisms*  
1658 2021b;**9**:468.
- 1659 Ho DK, Jarva H, Meri S. Human complement factor H binds to outer membrane protein Rck of  
1660 *Salmonella*. *The Journal of Immunology* 2010;**185**:1763–9.
- 1661 Ho DK, Ram S, Nelson KL *et al.* *LgtC* expression modulates resistance to C4b deposition on  
1662 an invasive nontypeable *Haemophilus influenzae*. *Journal of Immunology*  
1663 2007;**178**:1002–12.
- 1664 Ho DK, Riva R, Skurnik M *et al.* The *Yersinia pseudotuberculosis* outer membrane protein Ail  
1665 recruits the human complement regulatory protein factor H. *Journal of Immunology*

1666 2012;**189**:3593–9.

1667 Ho DK, Skurnik M, Blom AM *et al.* *Yersinia pestis* Ail recruitment of C4b-binding protein leads  
1668 to factor I-mediated inactivation of covalently and noncovalently bound C4b. *Eur J*  
1669 *Immunol* 2014;**44**:742–51.

1670 Ho DK, Tissari J, Järvinen HM *et al.* Functional recruitment of human complement inhibitor  
1671 C4b-binding protein to outer membrane protein Rck of *Salmonella*. *PLoS One*  
1672 2011;**6**:e27546.

1673 Ho YC, Hung FR, Weng CH *et al.* Lrp, a global regulator, regulates the virulence of *Vibrio*  
1674 *vulnificus*. *J Biomed Sci* 2017;**24**:54.

1675 Hoch JA. Two-component and phosphorelay signal transduction. *Curr Opin Microbiol*  
1676 2000;**3**:165–70.

1677 Hoiseth SK, Stocker BAD. Aromatic-dependent *Salmonella typhimurium* are non-virulent and  
1678 effective as live vaccines. *Nature* 1981;**291**:238–9.

1679 Holmes CL, Anderson MT, Mobley HLT *et al.* Pathogenesis of Gram-negative bacteremia. *Clin*  
1680 *Microbiol Rev* 2021;**34**:e00234-20.

1681 Holmes CL, Smith SN, Gurczynski SJ *et al.* The ADP-heptose biosynthesis enzyme GmhB is  
1682 a conserved Gram-negative bacteremia fitness factor. *Infect Immun* 2022;**90**.

1683 Hong Y, Ghebrehiwet B. Effect of *Pseudomonas aeruginosa* elastase and alkaline protease  
1684 on serum complement and isolated components C1q and C3. *Clin Immunol*  
1685 *Immunopathol* 1992;**62**:133–8.

1686 Hood MI, Skaar EP. Nutritional immunity: transition metals at the pathogen–host interface. *Nat*  
1687 *Rev Microbiol* 2012;**10**:525–37.

1688 Hooven TA, Catomeris AJ, Bonakdar M *et al.* The *Streptococcus agalactiae* stringent response  
1689 enhances virulence and persistence in human blood. *Infect Immun* 2018;**86**:e00612-17.

1690 Horwitz MA, Silverstein SC. Influence of the *Escherichia coli* capsule on complement fixation  
1691 and on phagocytosis and killing by human phagocytes. *J Clin Invest* 1980;**65**:82–94.

1692 Hotchkiss RS, Moldawer LL, Opal SM *et al.* Sepsis and septic shock. *Nat Rev Dis Primers*  
1693 2016;**2**:16045.



1694 Hovingh ES, van den Broek B, Jongerius I. Hijacking complement regulatory proteins for  
1695 bacterial immune evasion. *Front Microbiol* 2016;**7**:2004.

1696 Hsieh P, Lin T, Lee C *et al.* Serum-induced iron-acquisition systems and TonB contribute to  
1697 virulence in *Klebsiella pneumoniae* causing primary pyogenic liver abscess. *J Infect Dis*  
1698 2008;**197**:1717–27.

1699 Huang X, Lao W, Zhou Y *et al.* Glutamate dehydrogenase enables *Salmonella* to survive under  
1700 oxidative stress and escape from clearance in macrophages. *FEBS Lett* 2022;**596**:81–  
1701 94.

1702 Hui X, Xu Z, Cao L *et al.* HP0487 contributes to the virulence of *Streptococcus suis* serotype  
1703 2 by mediating bacterial adhesion and anti-phagocytosis to neutrophils. *Vet Microbiol*  
1704 2021;**260**:109164.

1705 Huja S, Oren Y, Biran D *et al.* Fur is the master regulator of the extraintestinal pathogenic  
1706 *Escherichia coli* response to serum. *mBio* 2014;**5**:e01460-14.

1707 Huja S, Oren Y, Trost E *et al.* Genomic avenue to avian colisepticemia. *mBio* 2015;**6**.

1708 Hyams C, Camberlein E, Cohen JM *et al.* The *Streptococcus pneumoniae* capsule inhibits  
1709 complement activity and neutrophil phagocytosis by multiple mechanisms. *Infect Immun*  
1710 2010;**78**:704–15.

1711 Hyre A, Casanova-Hampton K, Subashchandrabose S. Copper homeostatic mechanisms and  
1712 their role in the virulence of *Escherichia coli* and *Salmonella enterica*. *EcoSal Plus*  
1713 2021;**9**:eESP00142020.

1714 Irving SE, Choudhury NR, Corrigan RM. The stringent response and physiological roles of  
1715 (pp)pGpp in bacteria. *Nat Rev Microbiol* 2020;**19**:256–71.

1716 Itoh S, Hamada E, Kamoshida G *et al.* Staphylococcal superantigen-like protein 10 (SSL10)  
1717 binds to human immunoglobulin G (IgG) and inhibits complement activation via the  
1718 classical pathway. *Mol Immunol* 2010;**47**:932–8.

1719 Itoh S, Yokoyama R, Kamoshida G *et al.* Staphylococcal superantigen-like protein 10 (SSL10)  
1720 inhibits blood coagulation by binding to prothrombin and factor Xa via their  $\gamma$ -  
1721 carboxyglutamic acid (Gla) domain. *Journal of Biological Chemistry* 2013;**288**:21569–80.

- 1722 Ivánovics G, Marjai E, Dobozy A. The growth of purine mutants of *Bacillus anthracis* in the  
1723 body of the mouse. *J Gen Microbiol* 1968;**53**:147–62.
- 1724 Iwashyna TJ, Ely EW, Smith DM *et al.* Long-term cognitive impairment and functional disability  
1725 among survivors of severe sepsis. *JAMA* 2010;**304**:1787–94.
- 1726 Jacob-Dubuisson F, Mechaly A, Betton JM *et al.* Structural insights into the signalling  
1727 mechanisms of two-component systems. *Nat Rev Microbiol* 2018;**16**:585–93.
- 1728 James EH, Edwards AM, Wigneshweraraj S. Transcriptional downregulation of agr expression  
1729 in *Staphylococcus aureus* during growth in human serum can be overcome by  
1730 constitutively active mutant forms of the sensor kinase AgrC. *FEMS Microbiol Lett*  
1731 2013;**349**:153–62.
- 1732 Janet-Maitre M, Pont S, Masson FM *et al.* Genome-wide screen in human plasma identifies  
1733 multifaceted complement evasion of *Pseudomonas aeruginosa*. *PLoS Pathog*  
1734 2023;**19**:e1011023.
- 1735 Jarva H, Ram S, Vogel U *et al.* Binding of the complement inhibitor C4BP to serogroup B  
1736 *Neisseria meningitidis*. *The Journal of Immunology* 2005;**174**:6299–307.
- 1737 Jelsbak L, Thomsen LE, Wallrodt I *et al.* Polyamines are required for virulence in *Salmonella*  
1738 *enterica* serovar Typhimurium. *PLoS One* 2012;**7**:e36149.
- 1739 Jenkins A, Cote C, Twenhafel N *et al.* Role of purine biosynthesis in *Bacillus anthracis*  
1740 pathogenesis and virulence. *Infect Immun* 2011;**79**:153–66.
- 1741 Jenne CN, Urrutia R, Kubes P *et al.* Platelets: bridging hemostasis, inflammation, and  
1742 immunity. *Int J Lab Hematol* 2013;**35**:254–61.
- 1743 Jennings E, Thurston TLM, Holden DW. *Salmonella* SPI-2 type III secretion system effectors:  
1744 molecular mechanisms and physiological consequences. *Cell Host Microbe*  
1745 2017;**22**:217–31.
- 1746 Johnson CR, Newcombe J, Thorne S *et al.* Generation and characterization of a PhoP  
1747 homologue mutant of *Neisseria meningitidis*. *Mol Microbiol* 2001;**39**:1345–55.
- 1748 Johnson JR. Virulence factors in *Escherichia coli* urinary tract infection. *Clin Microbiol Rev*  
1749 1991;**4**:80-128.

- 1750 Johnson JR, Magistro G, Clabots C *et al.* Contribution of yersiniabactin to the virulence of an  
1751 *Escherichia coli* sequence type 69 (“clonal group A”) cystitis isolate in murine models of  
1752 urinary tract infection and sepsis. *Microb Pathog* 2018;**120**:128–31.
- 1753 Johnson MDL, Kehl-Fie TE, Klein R *et al.* Role of copper efflux in pneumococcal pathogenesis  
1754 and resistance to macrophage-mediated immune clearance. *Infect Immun* 2015;**83**:1684.
- 1755 Joiner KA, Grossman N, Schmetz M *et al.* C3 binds preferentially to long-chain  
1756 lipopolysaccharide during alternative pathway activation by *Salmonella montevideo*.  
1757 *Journal of Immunology* 1986;**136**:710–5.
- 1758 Joiner KA, Hammer CH, Brown EJ *et al.* Studies on the mechanism of bacterial resistance to  
1759 complement-mediated killing. I. Terminal complement components are deposited and  
1760 released from *Salmonella minnesota* S218 without causing bacterial death. *Journal of*  
1761 *Experimental Medicine* 1982;**155**:797–808.
- 1762 Jongerius I, von Köckritz-Blickwede M, Horsburgh MJ *et al.* *Staphylococcus aureus* virulence  
1763 is enhanced by secreted factors that block innate immune defenses. *J Innate Immun*  
1764 2012;**4**:301–11.
- 1765 Jongerius I, Köhl J, Pandey MK *et al.* Staphylococcal complement evasion by various  
1766 convertase-blocking molecules. *Journal of Experimental Medicine* 2007;**204**:2461–71.
- 1767 Jung CJ, Zheng QH, Shieh YH *et al.* *Streptococcus mutans* autolysin AtlA is a fibronectin-  
1768 binding protein and contributes to bacterial survival in the bloodstream and virulence for  
1769 infective endocarditis. *Mol Microbiol* 2009;**74**:888–902.
- 1770 Kaiser JC, Heinrichs DE. Branching out: alterations in bacterial physiology and virulence due  
1771 to branched-chain amino acid deprivation. *mBio* 2018;**9**.
- 1772 Kaiser JC, Omer S, Sheldon JR *et al.* Role of BrnQ1 and BrnQ2 in branched-chain amino acid  
1773 transport and virulence in *Staphylococcus aureus*. *Infect Immun* 2015;**83**:1019.
- 1774 Kandler JL, Joseph SJ, Balthazar JT *et al.* Phase-variable expression of *lptA* modulates the  
1775 resistance of *Neisseria gonorrhoeae* to cationic antimicrobial peptides. *Antimicrob Agents*  
1776 *Chemother* 2014;**58**:4230–3.
- 1777 Kanehisa M, Furumichi M, Sato Y *et al.* KEGG for taxonomy-based analysis of pathways and

1778 genomes. *Nucleic Acids Res* 2023;**51**:D587–92.

1779 Kanehisa M, Goto S. KEGG: Kyoto Encyclopedia of Genes and Genomes. *Nucleic Acids Res*  
1780 2000;**28**:27–30.

1781 Kang I-H, Kim J-S, Lee J-K. The virulence of *Vibrio vulnificus* is affected by the cellular level  
1782 of superoxide dismutase activity. *J Microbiol Biotechnol* 2007;**17**:1399–402.

1783 Kehl-Fie TE, Zhang Y, Moore JL *et al.* MntABC and MntH contribute to systemic  
1784 *Staphylococcus aureus* infection by competing with calprotectin for nutrient manganese.  
1785 *Infect Immun* 2013;**81**:3395.

1786 Kern W V., Rieg S. Burden of bacterial bloodstream infection—a brief update on epidemiology  
1787 and significance of multidrug-resistant pathogens. *Clinical Microbiology and Infection*  
1788 2020;**26**:151–7.

1789 Kho ZY, Azad MAK, Han ML *et al.* Correlative proteomics identify the key roles of stress  
1790 tolerance strategies in *Acinetobacter baumannii* in response to polymyxin and human  
1791 macrophages. *PLoS Pathog* 2022;**18**.

1792 Kim HJ, Lee H, Lee Y *et al.* The ThiL enzyme is a valid antibacterial target essential for both  
1793 thiamine biosynthesis and salvage pathways in *Pseudomonas aeruginosa*. *Journal of*  
1794 *Biological Chemistry* 2020;**295**:10081–91.

1795 Kim HK, Falugi F, Thomer L *et al.* Protein A suppresses immune responses during  
1796 *Staphylococcus aureus* bloodstream infection in guinea pigs. *mBio* 2015;**6**:e02369-14.

1797 Kim JO, Weiser JN. Association of intrastrain phase variation in quantity of capsular  
1798 polysaccharide and teichoic acid with the virulence of *Streptococcus pneumoniae*. *J Infect*  
1799 *Dis* 1998;**177**:368–77.

1800 Kim SH, Lee BY, Lau GW *et al.* IscR modulates catalase A (KatA) activity, peroxide resistance  
1801 and full virulence of *Pseudomonas aeruginosa* PA14. *J Microbiol Biotechnol*  
1802 2009a;**19**:1520–6.

1803 Kim SW, Choi CH, Moon DC *et al.* Serum resistance of *Acinetobacter baumannii* through the  
1804 binding of factor H to outer membrane proteins. *FEMS Microbiol Lett* 2009b;**301**:224–31.

1805 Kim YR, Lee SE, Kim CM *et al.* Characterization and pathogenic significance of *Vibrio*

1806 *vulnificus* antigens preferentially expressed in septicemic patients. *Infect Immun*  
1807 2003;**71**:5461–71.

1808 Kirjavainen V, Jarva H, Biedzka-Sarek M *et al.* *Yersinia enterocolitica* serum resistance  
1809 proteins YadA and Ail bind the complement regulator C4b-binding protein. *PLoS Pathog*  
1810 2008;**4**:e1000140.

1811 Ko YP, Kuipers A, Freitag CM *et al.* Phagocytosis escape by a *Staphylococcus aureus* protein  
1812 that connects complement and coagulation proteins at the bacterial surface. *PLoS Pathog*  
1813 2013;**9**:e1003816.

1814 Koch TK, Reuter M, Barthel D *et al.* *Staphylococcus aureus* proteins Sbi and Efb recruit human  
1815 plasmin to degrade complement C3 and C3b. *PLoS One* 2012;**7**:e47638.

1816 Kolodziejek AM, Hovde CJ, Minnich SA. Contributions of *Yersinia pestis* outer membrane  
1817 protein Ail to plague pathogenesis. *Curr Opin Infect Dis* 2022;**35**:188–95.

1818 Kovács M, Halfmann A, Fedtke I *et al.* A functional *dlt* operon, encoding proteins required for  
1819 incorporation of D-alanine in teichoic acids in gram-positive bacteria, confers resistance  
1820 to cationic antimicrobial peptides in *Streptococcus pneumoniae*. *J Bacteriol*  
1821 2006;**188**:5797–805.

1822 Krishna A, Holde MTG, Peacock SJ *et al.* Naturally occurring polymorphisms in the virulence  
1823 regulator Rsp modulate *Staphylococcus aureus* survival in blood and antibiotic  
1824 susceptibility. *Microbiology (N Y)* 2018;**164**:1189.

1825 Kronvall G, Gewurz H. Activation and inhibition of IgG mediated complement fixation by  
1826 staphylococcal protein A. *Clin Exp Immunol* 1970;**7**:211–20.

1827 Krukonis ES, Thomson JJ. Complement evasion mechanisms of the systemic pathogens  
1828 *Yersiniae* and *Salmonellae*. *FEBS Lett* 2020;**594**:2598–620.

1829 Kuo CF, Lin YS, Chuang WJ *et al.* Degradation of complement 3 by streptococcal pyrogenic  
1830 exotoxin B inhibits complement activation and neutrophil opsonophagocytosis. *Infect*  
1831 *Immun* 2008;**76**:1163–9.

1832 Laabei M, Ermert D. Catch me if you can: *Streptococcus pyogenes* complement evasion  
1833 strategies. *J Innate Immun* 2019;**11**:3–12.

- 1834 Laarman AJ, Bardoel BW, Ruyken M *et al.* *Pseudomonas aeruginosa* alkaline protease blocks  
1835 complement activation via the classical and lectin pathways. *The Journal of Immunology*  
1836 2012;**188**:386–93.
- 1837 Lambris JD, Ricklin D, Geisbrecht B V. Complement evasion by human pathogens. *Nat Rev*  
1838 *Microbiol* 2008;**6**:132–42.
- 1839 Langereis JD, Cremers AJH, Vissers M *et al.* Nontypeable *Haemophilus influenzae* invasive  
1840 blood isolates are mainly phosphorylcholine negative and show decreased complement-  
1841 mediated killing that is associated with lower binding of IgM and CRP in comparison to  
1842 colonizing isolates from the oropharynx. *Infect Immun* 2019;**87**:e00604-18.
- 1843 Langereis JD, Weiser JN. Shielding of a lipooligosaccharide IgM epitope allows evasion of  
1844 neutrophil-mediated killing of an invasive strain of nontypeable *Haemophilus influenzae*.  
1845 *mBio* 2014;**5**:e01478-14.
- 1846 Larochette V, Miot C, Poli C *et al.* IL-26, a cytokine with roles in extracellular DNA-induced  
1847 inflammation and microbial defense. *Front Immunol* 2019;**10**:204.
- 1848 Lathem WW, Bergsbaken T, Welch RA. Potentiation of C1 esterase inhibitor by StcE, a  
1849 metalloprotease secreted by *Escherichia coli* O157:H7. *J Exp Med* 2004;**199**:1077–87.
- 1850 Lee AK, Detweiler CS, Falkow S. OmpR regulates the two-component system SsrA-SsrB in  
1851 *Salmonella* pathogenicity island 2. *J Bacteriol* 2000;**182**:771–81.
- 1852 Lee EJ, Choi J, Groisman EA. Control of a *Salmonella* virulence operon by proline-charged  
1853 tRNA<sup>Pro</sup>. *Proc Natl Acad Sci U S A* 2014;**111**:3140–5.
- 1854 Lee EJ, Pontes MH, Groisman EA. A bacterial virulence protein promotes pathogenicity by  
1855 inhibiting the bacterium's own F<sub>1</sub>F<sub>o</sub> ATP synthase. *Cell* 2013;**154**:146–56.
- 1856 Le Guennec L, Coureuil M, Nassif X *et al.* Strategies used by bacterial pathogens to cross the  
1857 blood-brain barrier. *Cell Microbiol* 2020;**22**:e13132.
- 1858 Lemichez E, Lecuit M, Nassif X *et al.* Breaking the wall: targeting of the endothelium by  
1859 pathogenic bacteria. *Nat Rev Microbiol* 2010;**8**:93–104.
- 1860 Lensmire JM, Dodson JP, Hsueh BY *et al.* The *Staphylococcus aureus* cystine transporters  
1861 TcyABC and TcyP facilitate nutrient sulfur acquisition during infection. *Infect Immun*

- 1862 2020;**88**.
- 1863 Leung KY, Reisner BS, Straley SC. YopM inhibits platelet aggregation and is necessary for  
1864 virulence of *Yersinia pestis* in mice. *Infect Immun* 1990;**58**:3262–71.
- 1865 Levine HB, Maurer RL. Immunization with an induced avirulent auxotrophic mutant of  
1866 *Pseudomonas pseudomallei*. *The Journal of Immunology* 1958;**81**:433–8.
- 1867 Lewis LA, Carter M, Ram S. The relative roles of factor H binding protein, neisserial surface  
1868 protein A, and lipooligosaccharide sialylation in regulation of the alternative pathway of  
1869 complement on meningococci. *The Journal of Immunology* 2012;**188**:5063–72.
- 1870 Lewis LA, Choudhury B, Balthazar JT *et al*. Phosphoethanolamine substitution of lipid A and  
1871 resistance of *Neisseria gonorrhoeae* to cationic antimicrobial peptides and complement-  
1872 mediated killing by normal human serum. *Infect Immun* 2009;**77**:1112–20.
- 1873 Lewis LA, Ram S. Complement interactions with the pathogenic *Neisseriae*: clinical features,  
1874 deficiency states, and evasion mechanisms. *FEBS Lett* 2020;**594**:2670–94.
- 1875 Lewis LA, Rice PA, Ram S. Role of gonococcal neisserial surface protein A (NSpA) in serum  
1876 resistance and comparison of its factor H binding properties with those of its  
1877 meningococcal counterpart. *Infect Immun* 2019;**87**.
- 1878 Lewis LA, Shafer WM, Ray TD *et al*. Phosphoethanolamine residues on the lipid a moiety of  
1879 *Neisseria gonorrhoeae* lipooligosaccharide modulate binding of complement inhibitors  
1880 and resistance to complement killing. *Infect Immun* 2013;**81**:33–42.
- 1881 Li L, Bayer AS, Cheung A *et al*. The stringent response contributes to persistent methicillin-  
1882 resistant *Staphylococcus aureus* endovascular infection through the purine biosynthetic  
1883 pathway. *J Infect Dis* 2020;**222**:1188–98.
- 1884 Li MS, Chow NYS, Sinha S *et al*. A *Neisseria meningitidis* NMB1966 mutant is impaired for  
1885 invasion of respiratory epithelial cells, survival in human blood and for virulence *in vivo*.  
1886 *Med Microbiol Immunol* 2009;**198**:57–67.
- 1887 Li P, Wang X, Smith C *et al*. Dissecting *psa* locus regulation in *Yersinia pestis*. *J Bacteriol*  
1888 2021;**203**.
- 1889 Li W, Wen L, Li C *et al*. Contribution of the outer membrane protein OmpW in *Escherichia coli*

1890 to complement resistance from binding to factor H. *Microb Pathog* 2016;**98**:57–62.

1891 Libby SJ, Goebel W, Ludwig A *et al.* A cytolysin encoded by *Salmonella* is required for survival  
1892 within macrophages. *Proceedings of the National Academy of Sciences* 1994;**91**:489–93.

1893 Lindler LE, Klempner MS, Straley SC. *Yersinia pestis* pH 6 antigen: genetic, biochemical, and  
1894 virulence characterization of a protein involved in the pathogenesis of bubonic plague.  
1895 *Infect Immun* 1990;**58**:2569–77.

1896 Linehan SA, Rytönen A, Yu XJ *et al.* SlyA regulates function of *Salmonella* pathogenicity  
1897 island 2 (SPI-2) and expression of SPI-2-associated genes. *Infect Immun* 2005;**73**:4354.

1898 Liu H, Ye C, Fu H *et al.* Stk and Stp1 participate in *Streptococcus suis* serotype 2 pathogenesis  
1899 by regulating capsule thickness and translocation of certain virulence factors. *Microb*  
1900 *Pathog* 2021;**152**:104607.

1901 Liu Y, Zhang D, Engström Å *et al.* Dynamic niche-specific adaptations in *Neisseria meningitidis*  
1902 during infection. *Microbes Infect* 2016;**18**:109–17.

1903 Locke JB, Colvin KM, Datta AK *et al.* *Streptococcus iniae* capsule impairs phagocytic clearance  
1904 and contributes to virulence in fish. *J Bacteriol* 2007;**189**:1279–87.

1905 Lockhart PB, Brennan MT, Sasser HC *et al.* Bacteremia associated with toothbrushing and  
1906 dental extraction. *Circulation* 2008;**117**:3118–25.

1907 Loh E, Kugelberg E, Tracy A *et al.* Temperature triggers immune evasion by *Neisseria*  
1908 *meningitidis*. *Nature* 2013;**502**:237–40.

1909 Loh E, Righetti F, Eichner H *et al.* RNA thermometers in bacterial pathogens. *Microbiol Spectr*  
1910 2018;**6**.

1911 Lourdault K, Matsunaga J, Haake DA. High-Throughput parallel sequencing to measure fitness  
1912 of *Leptospira interrogans* transposon insertion mutants during acute infection. *PLoS Negl*  
1913 *Trop Dis* 2016;**10**:e0005117.

1914 Lynskey NN, Reglinski M, Calay D *et al.* Multi-functional mechanisms of immune evasion by  
1915 the streptococcal complement inhibitor C5a peptidase. *PLoS Pathog* 2017;**13**:e1006493.

1916 Ma J, Cheng Z, Bai Q *et al.* Screening virulence factors of porcine extraintestinal pathogenic  
1917 *Escherichia coli* (an emerging pathotype) required for optimal growth in swine blood.



- 1918 *Transbound Emerg Dis* 2021;**68**:2005–16.
- 1919 Ma J, Pan X, Zhong X *et al.* Preferential use of carbon central metabolism and anaerobic  
1920 respiratory chains in porcine extraintestinal pathogenic *Escherichia coli* during  
1921 bloodstream infection. *Vet Microbiol* 2020;**249**:108830.
- 1922 MacKinnon MC, McEwen SA, Pearl DL *et al.* Mortality in *Escherichia coli* bloodstream  
1923 infections: a multinational population-based cohort study. *BMC Infect Dis* 2021;**21**:606.
- 1924 Madico G, Welsch JA, Lewis LA *et al.* The meningococcal vaccine candidate GNA1870 binds  
1925 the complement regulatory protein factor H and enhances serum resistance. *Journal of*  
1926 *Immunology* 2006;**177**:501–10.
- 1927 Maisey HC, Quach D, Hensler ME *et al.* A group B streptococcal pilus protein promotes  
1928 phagocyte resistance and systemic virulence. *The FASEB Journal* 2008;**22**:1715–24.
- 1929 Malachowa N, DeLeo FR. *Staphylococcus aureus* survival in human blood. *Virulence*  
1930 2011;**2**:567–9.
- 1931 Malachowa N, Whitney AR, Kobayashi SD *et al.* Global changes in *Staphylococcus aureus*  
1932 gene expression in human blood. *PLoS One* 2011;**6**:18617.
- 1933 Mandell GL. Catalase, superoxide dismutase, and virulence of *Staphylococcus aureus*. *In vitro*  
1934 and *in vivo* studies with emphasis on staphylococcal–leukocyte interaction. *J Clin Invest*  
1935 1975;**55**:561–6.
- 1936 Mann B, van Opijnen T, Wang J *et al.* Control of virulence by small RNAs in *Streptococcus*  
1937 *pneumoniae*. *PLoS Pathog* 2012;**8**:34.
- 1938 Marketon MM, DePaolo RW, DeBord KL *et al.* Plague bacteria target immune cells during  
1939 infection. *Science (1979)* 2005;**309**:1739–41.
- 1940 Mason KM, Bruggeman ME, Munson RS *et al.* The non-typeable *Haemophilus influenzae* Sap  
1941 transporter provides a mechanism of antimicrobial peptide resistance and SapD-  
1942 dependent potassium acquisition. *Mol Microbiol* 2006;**62**:1357–72.
- 1943 Mason KM, Munson RS, Bakaletz LO. A mutation in the *sap* operon attenuates survival of  
1944 nontypeable *Haemophilus influenzae* in a chinchilla model of otitis media. *Infect Immun*  
1945 2005;**73**:599–608.

- 1946 Mastellos DC, Hajishengallis G, Lambris JD. A guide to complement biology, pathology and  
1947 therapeutic opportunity. *Nat Rev Immunol* 2023;**24**:118–41.
- 1948 Mateu-Borrás M, Zamorano L, González-Alsina A *et al.* Molecular analysis of the contribution  
1949 of alkaline protease A and elastase B to the virulence of *Pseudomonas aeruginosa*  
1950 bloodstream infections. *Front Cell Infect Microbiol* 2022;**11**:816356.
- 1951 McAdow M, Kim HK, DeDent AC *et al.* Preventing *Staphylococcus aureus* sepsis through the  
1952 inhibition of its agglutination in blood. *PLoS Pathog* 2011;**7**:e1002307.
- 1953 McCarthy AJ, Stabler RA, Taylor PW. Genome-wide identification by transposon insertion  
1954 sequencing of *Escherichia coli* K1 genes essential for in vitro growth, gastrointestinal  
1955 colonizing capacity, and survival in serum. *J Bacteriol* 2018;**200**:e00698-17.
- 1956 McFarland WC, Stocker BAD. Effect of different purine auxotrophic mutations on mouse-  
1957 virulence of a Vi-positive strain of *Salmonella dublin* and of two strains of *Salmonella*  
1958 *typhimurium*. *Microb Pathog* 1987;**3**:129–41.
- 1959 Mei JM, Nourbakhsh F, Ford CW *et al.* Identification of *Staphylococcus aureus* virulence genes  
1960 in a murine model of bacteraemia using signature-tagged mutagenesis. *Mol Microbiol*  
1961 1997;**26**:399–407.
- 1962 Mendum TA, Newcombe J, Mannan AA *et al.* Interrogation of global mutagenesis data with a  
1963 genome scale model of *Neisseria meningitidis* to assess gene fitness *in vitro* and in sera.  
1964 *Genome Biol* 2011;**12**:R127.
- 1965 Merino S, Camprubi S, Alberti S *et al.* Mechanisms of *Klebsiella pneumoniae* resistance to  
1966 complement-mediated killing. *Infect Immun* 1992;**60**:2529–35.
- 1967 Miajlovic H, Smith SG. Bacterial self-defence: how *Escherichia coli* evades serum killing.  
1968 *FEMS Microbiol Lett* 2014;**354**:1–9.
- 1969 Miller SI, Kukral AM, Mekalanos JJ. A two-component regulatory system (*phoP phoQ*) controls  
1970 *Salmonella typhimurium* virulence. *Proc Natl Acad Sci U S A* 1989;**86**:5054.
- 1971 Minato Y, Ghosh A, Faulkner WJ *et al.* Na<sup>+</sup>/H<sup>+</sup> antiport is essential for *Yersinia pestis* virulence.  
1972 *Infect Immun* 2013;**81**:3163–72.
- 1973 Mishra M, Byrd MS, Sergeant S *et al.* *Pseudomonas aeruginosa* Psl polysaccharide reduces

- 1974 neutrophil phagocytosis and the oxidative response by limiting complement-mediated  
1975 opsonization. *Cell Microbiol* 2012;**14**:95–106.
- 1976 Murdoch CC, Skaar EP. Nutritional immunity: the battle for nutrient metals at the host–  
1977 pathogen interface. *Nat Rev Microbiol* 2022;**20**:657–70.
- 1978 Nabera CK. *Staphylococcus aureus* bacteremia: epidemiology, pathophysiology, and  
1979 management strategies. *Clinical Infectious Diseases* 2009;**48**:S231–7.
- 1980 Nathan C. Neutrophils and immunity: challenges and opportunities. *Nat Rev Immunol*  
1981 2006;**6**:173–82.
- 1982 Needham BD, Trent MS. Fortifying the barrier: the impact of lipid A remodelling on bacterial  
1983 pathogenesis. *Nat Rev Microbiol* 2013;**11**:467–81.
- 1984 Newcombe J, Eales-Reynolds LJ, Wootton L *et al.* Infection with an avirulent *phoP* mutant of  
1985 *Neisseria meningitidis* confers broad cross-reactive immunity. *Infect Immun*  
1986 2004;**72**:338–44.
- 1987 Noel GJ, Brittingham A, Granato AA *et al.* Effect of amplification of the Cap b locus on  
1988 complement-mediated bacteriolysis and opsonization of type b *Haemophilus influenzae*.  
1989 *Infect Immun* 1996;**64**:4769–75.
- 1990 O’Keeffe KM, Wilk MM, Leech JM *et al.* Manipulation of autophagy in phagocytes facilitates  
1991 *Staphylococcus aureus* bloodstream infection. *Infect Immun* 2015;**83**:3445–57.
- 1992 Olive AJ, Sasseti CM. Metabolic crosstalk between host and pathogen: sensing, adapting and  
1993 competing. *Nat Rev Microbiol* 2016;**14**:221–34.
- 1994 Ong CLY, Berking O, Walker MJ *et al.* New insights into the role of zinc acquisition and zinc  
1995 tolerance in group A streptococcal infection. *Infect Immun* 2018;**86**:e00048-18.
- 1996 Oogai Y, Yamaguchi M, Kawada-Matsuo M *et al.* Lysine and threonine biosynthesis from  
1997 aspartate contributes to *Staphylococcus aureus* growth in calf serum. *Appl Environ*  
1998 *Microbiol* 2016;**82**:6150–7.
- 1999 Osborne SE, Coombes BK. RpoE fine tunes expression of a subset of SsrB-regulated  
2000 virulence factors in *Salmonella enterica* serovar Typhimurium. *BMC Microbiol* 2009;**9**:45.
- 2001 Painter KL, Hall A, Ha KP *et al.* The electron transport chain sensitizes *Staphylococcus aureus*

- 2002 and *Enterococcus faecalis* to the oxidative burst. *Infect Immun* 2017;**85**:e00659-17.
- 2003 Palace SG, Proulx MK, Lu S *et al.* Genome-wide mutant fitness profiling identifies nutritional  
2004 requirements for optimal growth of *Yersinia pestis* in deep tissue. *mBio* 2014;**5**:e01385-  
2005 14.
- 2006 Palace SG, Vitseva O, Proulx MK *et al.* *Yersinia pestis* escapes entrapment in thrombi by  
2007 targeting platelet function. *Journal of Thrombosis and Haemostasis* 2020;**18**:3236–48.
- 2008 Palm F, Sjöholm K, Malmström J *et al.* Complement activation occurs at the surface of platelets  
2009 activated by streptococcal M1 protein and this results in phagocytosis of platelets. *The*  
2010 *Journal of Immunology* 2019;**202**:503–13.
- 2011 Palmqvist N, Patti JM, Tarkowski A *et al.* Expression of staphylococcal clumping factor A  
2012 impedes macrophage phagocytosis. *Microbes Infect* 2004;**6**:188–95.
- 2013 Pappesch R, Warnke P, Mikkat S *et al.* The regulatory small RNA MarS supports virulence of  
2014 *Streptococcus pyogenes*. *Sci Rep* 2017;**7**:12241.
- 2015 Parra-Lopez C, Lin R, Aspedon A *et al.* A *Salmonella* protein that is required for resistance to  
2016 antimicrobial peptides and transport of potassium. *EMBO J* 1994;**13**:3964–72.
- 2017 Paterson GK, Cone DB, Peters SE *et al.* The enzyme phosphoglucomutase (Pgm) is required  
2018 by *Salmonella enterica* serovar Typhimurium for O-antigen production, resistance to  
2019 antimicrobial peptides and *in vivo* fitness. *Microbiology (N Y)* 2009;**155**:3403–10.
- 2020 Pei X, Liu M, Zhou H *et al.* Screening for phagocytosis resistance-related genes via a  
2021 transposon mutant library of *Streptococcus suis* serotype 2. *Virulence* 2020;**11**:825–38.
- 2022 Perry RD, Bobrov AG, Fetherston JD. The role of transition metal transporters for iron, zinc,  
2023 manganese, and copper in the pathogenesis of *Yersinia pestis*. *Metallomics* 2015;**7**:965–  
2024 78.
- 2025 Phan M-D, Peters KM, Sarkar S *et al.* The serum resistome of a globally disseminated  
2026 multidrug resistant uropathogenic *Escherichia coli* clone. *PLoS Genet* 2013;**9**:e1003834.
- 2027 Pian Y, Li X, Zheng Y *et al.* Binding of human fibrinogen to MRP enhances *Streptococcus suis*  
2028 survival in host blood in a  $\alpha_x\beta_2$  integrin-dependent manner. *Sci Rep* 2016;**6**:26966.
- 2029 Pietrocola G, Nobile G, Rindi S *et al.* *Staphylococcus aureus* manipulates innate immunity

2030 through own and host-expressed proteases. *Front Cell Infect Microbiol* 2017;**7**:166.

2031 Pinaud L, Sansonetti PJ, Phalipon A. Host cell targeting by enteropathogenic bacteria T3SS  
2032 effectors. *Trends Microbiol* 2018;**26**:266–83.

2033 Pishchany G, McCoy AL, Torres VJ *et al.* Specificity for human hemoglobin enhances  
2034 *Staphylococcus aureus* infection. *Cell Host Microbe* 2010;**8**:544–50.

2035 Pishchany G, Sheldon JR, Dickson CF *et al.* IsdB-dependent hemoglobin binding is required  
2036 for acquisition of heme by *Staphylococcus aureus*. *J Infect Dis* 2014;**209**:1764–72.

2037 Pokorzynski ND, Groisman EA. How bacterial pathogens coordinate appetite with virulence.  
2038 *Microbiology and Molecular Biology Reviews* 2023;**87**:e0019822.

2039 Polissi A, Pontiggia A, Feger G *et al.* Large-scale identification of virulence genes from  
2040 *Streptococcus pneumoniae*. *Infect Immun* 1998;**66**:5620–9.

2041 Pont S, Fraikin N, Caspar Y *et al.* Bacterial behavior in human blood reveals complement  
2042 evaders with some persister-like features. *PLoS Pathog* 2020;**16**:e1008893.

2043 Poyart C, Pellegrini E, Gaillot O *et al.* Contribution of Mn-cofactored superoxide dismutase  
2044 (SodA) to the virulence of *Streptococcus agalactiae*. *Infect Immun* 2001;**69**:5098–106.

2045 Poyart C, Pellegrini E, Marceau M *et al.* Attenuated virulence of *Streptococcus agalactiae*  
2046 deficient in D-alanyl-lipoteichoic acid is due to an increased susceptibility to defensins  
2047 and phagocytic cells. *Mol Microbiol* 2003;**49**:1615–25.

2048 Pramoonjago P, Kaneko M, Kinoshita T *et al.* Role of TraT protein, an anticomplementary  
2049 protein produced in *Escherichia coli* by R100 factor, in serum resistance. *The Journal of*  
2050 *Immunology* 1992;**148**.

2051 Priebe GP, Dean CR, Zaidi T *et al.* The *galU* gene of *Pseudomonas aeruginosa* is required for  
2052 corneal infection and efficient systemic spread following pneumonia but not for infection  
2053 confined to the lung. *Infect Immun* 2004;**72**:4224–32.

2054 Qadi M, Izquierdo-Rabassa S, Mateu Borrás M *et al.* Sensing Mg<sup>2+</sup> contributes to the  
2055 resistance of *Pseudomonas aeruginosa* to complement-mediated opsonophagocytosis.  
2056 *Environ Microbiol* 2017;**19**:4278–86.

2057 Qiu P, Li Y, Shiloach J *et al.* *Bacillus anthracis* cell wall peptidoglycan but not lethal or edema

2058 toxins produces changes consistent with disseminated intravascular coagulation in a rat  
2059 model. *J Infect Dis* 2013;**208**:978–89.

2060 Quinn JD, Weening EH, Miller VL. PsaF is a membrane-localized pH sensor that regulates  
2061 *psaA* expression in *Yersinia pestis*. *J Bacteriol* 2021;**203**.

2062 Quinn JD, Weening EH, Miner TA *et al*. Temperature control of *psaA* expression by PsaE and  
2063 PsaF in *Yersinia pestis*. *J Bacteriol* 2019;**201**:e00217-19.

2064 Rajagopal L, Vo A, Silvestroni A *et al*. Regulation of cytotoxin expression by converging  
2065 eukaryotic-type and two-component signalling mechanisms in *Streptococcus agalactiae*.  
2066 *Mol Microbiol* 2006;**62**:941–57.

2067 Ram S, Cullinane M, Blom AM *et al*. Binding of C4b-binding protein to porin: a molecular  
2068 mechanism of serum resistance of *Neisseria gonorrhoeae*. *Journal of Experimental*  
2069 *Medicine* 2001;**193**:281–96.

2070 Ram S, Ngampasutadol J, Cox AD *et al*. Heptose I glycan substitutions on *Neisseria*  
2071 *gonorrhoeae* lipooligosaccharide influence C4b-binding protein binding and serum  
2072 resistance. *Infect Immun* 2007;**75**:4071–81.

2073 Ramu P, Tanskanen R, Holmberg M *et al*. The surface protease PgtE of *Salmonella enterica*  
2074 affects complement activity by proteolytically cleaving C3b, C4b and C5. *FEBS Lett*  
2075 2007;**581**:1716–20.

2076 Reckseidler-Zenteno SL, DeVinney R, Woods DE. The capsular polysaccharide of  
2077 *Burkholderia pseudomallei* contributes to survival in serum by reducing complement  
2078 factor C3b deposition. *Infect Immun* 2005;**73**:1106–15.

2079 Reddy EA, Shaw A V., Crump JA. Community-acquired bloodstream infections in Africa: a  
2080 systematic review and meta-analysis. *Lancet Infect Dis* 2010;**10**:417–32.

2081 Reinhart K, Daniels R, Kisson N *et al*. Recognizing sepsis as a global health priority — A  
2082 WHO resolution. *New England Journal of Medicine* 2017;**377**:414–7.

2083 Renauld-Mongénie G, Poncet D, Mignon M *et al*. Role of transferrin receptor from a *Neisseria*  
2084 *meningitidis* *tbpB* isotype II strain in human transferrin binding and virulence. *Infect Immun*  
2085 2004;**72**:3461.

2086 Ricklin D, Hajishengallis G, Yang K *et al.* Complement: a key system for immune surveillance  
2087 and homeostasis. *Nat Immunol* 2010;**11**:785–97.

2088 Riesbeck K. Complement evasion by the human respiratory tract pathogens  
2089 *Haemophilus influenzae* and *Moraxella catarrhalis*. *FEBS Lett* 2020;**594**:2586–97.

2090 Riva R, Korhonen TK, Meri S. The outer membrane protease PgtE of *Salmonella enterica*  
2091 interferes with the alternative complement pathway by cleaving factors B and H. *Front*  
2092 *Microbiol* 2015;**6**:63.

2093 Robertson BD, Frosch M, van Putten JPM. The role of *galE* in the biosynthesis and function of  
2094 gonococcal lipopolysaccharide. *Mol Microbiol* 1993;**8**:891–901.

2095 Roggenkamp A, Bittner T, Leitritz L *et al.* Contribution of the Mn-cofactored superoxide  
2096 dismutase (SodA) to the virulence of *Yersinia enterocolitica* serotype O8. *Infect Immun*  
2097 1997;**65**:4705.

2098 Rooijackers SHM, Ruyken M, Roos A *et al.* Immune evasion by a staphylococcal complement  
2099 inhibitor that acts on C3 convertases. *Nat Immunol* 2005a;**6**:920–7.

2100 Rooijackers SHM, Van Wamel WJB, Ruyken M *et al.* Anti-opsonic properties of  
2101 staphylokinase. *Microbes Infect* 2005b;**7**:476–84.

2102 Rosch JW, Sublett J, Gao G *et al.* Calcium efflux is essential for bacterial survival in the  
2103 eukaryotic host. *Mol Microbiol* 2008;**70**:435–44.

2104 Rosso ML, Chauvaux S, Dessein R *et al.* Growth of *Yersinia pseudotuberculosis* in human  
2105 plasma: impacts on virulence and metabolic gene expression. *BMC Microbiol* 2008;**8**:211.

2106 Runci F, Gentile V, Frangipani E *et al.* Contribution of active iron uptake to *Acinetobacter*  
2107 *baumannii* pathogenicity. *Infect Immun* 2019;**87**.

2108 Sabri M, Caza M, Proulx J *et al.* Contribution of the SitABCD, MntH, and FeoB metal  
2109 transporters to the virulence of avian pathogenic *Escherichia coli* O78 strain  $\chi$ 7122. *Infect*  
2110 *Immun* 2008;**76**:601–11.

2111 Samant S, Hsu FF, Neyfakh AA *et al.* The *Bacillus anthracis* protein MprF is required for  
2112 synthesis of lysylphosphatidylglycerols and for resistance to cationic antimicrobial  
2113 peptides. *J Bacteriol* 2009;**191**:1311–9.

- 2114 Samant S, Lee H, Ghassemi M *et al.* Nucleotide biosynthesis is critical for growth of bacteria  
2115 in human blood. *PLoS Pathog* 2008;**4**:e37.
- 2116 Sanchez-Larrayoz AF, Elhosseiny NM, Chevrette MG *et al.* Complexity of complement  
2117 resistance factors expressed by *Acinetobacter baumannii* needed for survival in human  
2118 serum. *The Journal of Immunology* 2017;**199**:2803–14.
- 2119 Sarkar S, Ulett GC, Totsika M *et al.* Role of capsule and O antigen in the virulence of  
2120 uropathogenic *Escherichia coli*. *PLoS One* 2014;**9**:e94786.
- 2121 Sassetti CM, Boyd DH, Rubin EJ. Comprehensive identification of conditionally essential  
2122 genes in *Mycobacteria*. *Proc Natl Acad Sci U S A* 2001;**98**:12712.
- 2123 Schatz-Jakobsen JA, Pedersen D V., Andersen GR. Structural insight into proteolytic  
2124 activation and regulation of the complement system. *Immunol Rev* 2016;**274**:59–73.
- 2125 Schauer K, Stolz J, Scherer S *et al.* Both thiamine uptake and biosynthesis of thiamine  
2126 precursors are required for intracellular replication of *Listeria monocytogenes*. *J Bacteriol*  
2127 2009;**191**:2218–27.
- 2128 Schneider MC, Exley RM, Ram S *et al.* Interactions between *Neisseria meningitidis* and the  
2129 complement system. *Trends Microbiol* 2007;**15**:233–40.
- 2130 Schwan WR, Warrener P, Keunz E *et al.* Mutations in the *cueA* gene encoding a copper  
2131 homeostasis P-type ATPase reduce the pathogenicity of *Pseudomonas aeruginosa* in  
2132 mice. *International Journal of Medical Microbiology* 2005;**295**:237–42.
- 2133 Sebbane F, Jarrett CO, Gardner D *et al.* Role of the *Yersinia pestis* plasminogen activator in  
2134 the incidence of distinct septicemic and bubonic forms of flea-borne plague. *Proc Natl*  
2135 *Acad Sci U S A* 2006;**103**:5526–30.
- 2136 Sebbane F, Uversky VN, Anisimov AP. *Yersinia pestis* plasminogen activator. *Biomolecules*  
2137 2020;**10**:1554.
- 2138 Sebkova A, Karasova D, Crhanova M *et al.* *aro* mutations in *Salmonella enterica* cause defects  
2139 in cell wall and outer membrane integrity. *J Bacteriol* 2008;**190**:3155–60.
- 2140 Seib KL, Serruto D, Oriente F *et al.* Factor H-binding protein is important for meningococcal  
2141 survival in human whole blood and serum and in the presence of the antimicrobial peptide



2142 LL-37. *Infect Immun* 2009;**77**:292–9.

2143 Sharma S, Bhatnagar R, Gaur D. *Bacillus anthracis* poly-γ-D-glutamate capsule inhibits  
2144 opsonic phagocytosis by impeding complement activation. *Front Immunol* 2020;**11**:462.

2145 Sharp JA, Echague CG, Hair PS *et al.* *Staphylococcus aureus* surface protein SdrE binds  
2146 complement regulator factor H as an immune evasion tactic. *PLoS One* 2012;**7**:e38407.

2147 Sheldon JR, Skaar EP. Metals as phagocyte antimicrobial effectors. *Curr Opin Immunol*  
2148 2019;**60**:1–9.

2149 Shin K, Lechtenberg BC, Fujimoto LM *et al.* Structure of human Vitronectin C-terminal domain  
2150 and interaction with *Yersinia pestis* outer membrane protein Ail. *Sci Adv*  
2151 2019;**5**:eaax5068.

2152 Short FL, Di Sario G, Reichmann NT *et al.* Genomic profiling reveals distinct routes to  
2153 complement resistance in *Klebsiella pneumoniae*. *Infect Immun* 2020;**88**:e00043-20.

2154 Siemens N, Fiedler T, Normann J *et al.* Effects of the ERES pathogenicity region regulator  
2155 Ralp3 on *Streptococcus pyogenes* serotype M49 virulence factor expression. *J Bacteriol*  
2156 2012;**194**:3618–26.

2157 Skorek K, Raczowska A, Dudek B *et al.* Regulatory protein OmpR influences the serum  
2158 resistance of *Yersinia enterocolitica* O:9 by modifying the structure of the outer  
2159 membrane. *PLoS One* 2013;**8**:e79525.

2160 Smith RE, Salamaga B, Szkuta P *et al.* Decoration of the enterococcal polysaccharide antigen  
2161 EPA is essential for virulence, cell surface charge and interaction with effectors of the  
2162 innate immune system. *PLoS Pathog* 2019;**15**:e1007730.

2163 Soutourina O, Dubrac S, Poupel O *et al.* The pleiotropic CymR regulator of *Staphylococcus*  
2164 *aureus* plays an important role in virulence and stress response. *PLoS Pathog*  
2165 2010;**6**:e1000894.

2166 De Souza-Hart JA, Blackstock W, Di Modugno V *et al.* Two-component systems in  
2167 *Haemophilus influenzae*: a regulatory role for ArcA in serum resistance. *Infect Immun*  
2168 2003;**71**:163–72.

2169 Spaan AN, Reyes-Robles T, Badiou C *et al.* *Staphylococcus aureus* targets the Duffy antigen

2170 receptor for chemokines (DARC) to lyse erythrocytes. *Cell Host Microbe* 2015;**18**:363–  
2171 70.

2172 Spinsanti M, Brignoli T, Bodini M *et al.* Deconvolution of intergenic polymorphisms determining  
2173 high expression of Factor H binding protein in meningococcus and their association with  
2174 invasive disease. *PLoS Pathog* 2021;**17**:e1009461.

2175 Stewardson AJ, Allignol A, Beyersmann J *et al.* The health and economic burden of  
2176 bloodstream infections caused by antimicrobial-susceptible and non-susceptible  
2177 *Enterobacteriaceae* and *Staphylococcus aureus* in European hospitals, 2010 and 2011:  
2178 a multicentre retrospective cohort study. *Eurosurveillance* 2016;**21**:30319.

2179 Stojjkovic I, Hwa V, de Saint Martin L *et al.* The *Neisseria meningitidis* haemoglobin receptor:  
2180 its role in iron utilization and virulence. *Mol Microbiol* 1995;**15**:531–41.

2181 Stritzker J, Janda J, Schoen C *et al.* Growth, virulence, and immunogenicity of *Listeria*  
2182 *monocytogenes* aro mutants. *Infect Immun* 2004;**72**:5622–9.

2183 Stubben CJ, Duffield ML, Cooper IA *et al.* Steps toward broad-spectrum therapeutics:  
2184 discovering virulence-associated genes present in diverse human pathogens. *BMC*  
2185 *Genomics* 2009;**10**:501.

2186 Su J, Gong H, Lai J *et al.* The potassium transporter Trk and external potassium modulate  
2187 *Salmonella enterica* protein secretion and virulence. *Infect Immun* 2009;**77**:667–75.

2188 Subashchandrabose S, Smith S, DeOrnellas V *et al.* *Acinetobacter baumannii* genes required  
2189 for bacterial survival during bloodstream infection. *mSphere* 2016;**1**:e00013-15.

2190 Subashchandrabose S, Smith SN, Spurbeck RR *et al.* Genome-wide detection of fitness genes  
2191 in uropathogenic *Escherichia coli* during systemic infection. Camilli A (ed.). *PLoS Pathog*  
2192 2013;**9**:e1003788.

2193 Sugareva V, Arit R, Fiedler T *et al.* Serotype- and strain- dependent contribution of the sensor  
2194 kinase CovS of the CovRS two-component system to *Streptococcus pyogenes*  
2195 pathogenesis. *BMC Microbiol* 2010;**10**:34.

2196 Sun D, Popescu NI, Raisley B *et al.* *Bacillus anthracis* peptidoglycan activates human platelets  
2197 through FcγRII and complement. *Blood* 2013;**122**:571–9.

- 2198 Sun H, Song Y, Chen F *et al.* An ArcA-modulated small RNA in pathogenic *Escherichia coli*  
2199 K1. *Front Microbiol* 2020;**11**:574833.
- 2200 Sun YH, Bakshi S, Chalmers R *et al.* Functional genomics of *Neisseria meningitidis*  
2201 pathogenesis. *Nat Med* 2000;**6**:1269–73.
- 2202 Sundar GS, Islam E, Braza RD *et al.* Route of glucose uptake in the group A *Streptococcus*  
2203 impacts SLS-mediated hemolysis and survival in human blood. *Front Cell Infect Microbiol*  
2204 2018;**8**:71.
- 2205 Syed S, Hakala P, Singh AK *et al.* Role of pneumococcal NanA neuraminidase activity in  
2206 peripheral blood. *Front Cell Infect Microbiol* 2019;**9**:218.
- 2207 Syed S, Viazmina L, Mager R *et al.* Streptococci and the complement system: interplay during  
2208 infection, inflammation and autoimmunity. *FEBS Lett* 2020;**594**:2570–85.
- 2209 Talà A, Monaco C, Nagorska K *et al.* Glutamate utilization promotes meningococcal survival  
2210 in vivo through avoidance of the neutrophil oxidative burst. *Mol Microbiol* 2011;**81**:1330–  
2211 42.
- 2212 Talyansky Y, Nielsen TB, Yan J *et al.* Capsule carbohydrate structure determines virulence in  
2213 *Acinetobacter baumannii*. *PLoS Pathog* 2021;**17**:e1009291.
- 2214 Tang Y, Zhang X, Wu W *et al.* Inactivation of the *sodA* gene of *Streptococcus suis* type 2  
2215 encoding superoxide dismutase leads to reduced virulence to mice. *Vet Microbiol*  
2216 2012;**158**:360–6.
- 2217 Taylor PW. Bactericidal and bacteriolytic activity of serum against Gram-negative bacteria.  
2218 *Microbiol Rev* 1983;**47**:46–83.
- 2219 Terao Y, Mori Y, Yamaguchi M *et al.* Group A streptococcal cysteine protease degrades C3  
2220 (C3b) and contributes to evasion of innate immunity. *J Biol Chem* 2008;**283**:6253–60.
- 2221 Terwilliger A, Swick MC, Pflughoeft KJ *et al.* *Bacillus anthracis* overcomes an amino acid  
2222 auxotrophy by cleaving host serum proteins. *J Bacteriol* 2015;**197**:2400–11.
- 2223 Thakker M, Park JS, Carey V *et al.* *Staphylococcus aureus* serotype 5 capsular polysaccharide  
2224 is antiphagocytic and enhances bacterial virulence in a murine bacteremia model. *Infect*  
2225 *Immun* 1998;**66**:5183–9.

- 2226 Thammavongsa V, Kern JW, Missiakas DM *et al.* *Staphylococcus aureus* synthesizes  
2227 adenosine to escape host immune responses. *Journal of Experimental Medicine*  
2228 2009;**206**:2417–27.
- 2229 Thedieck K, Hain T, Mohamed W *et al.* The MprF protein is required for lysinylation of  
2230 phospholipids in listerial membranes and confers resistance to cationic antimicrobial  
2231 peptides (CAMPs) on *Listeria monocytogenes*. *Mol Microbiol* 2006;**62**:1325–39.
- 2232 Thomson JJ, Plecha SC, Krukonis ES. Ail provides multiple mechanisms of serum resistance  
2233 to *Yersinia pestis*. *Mol Microbiol* 2019;**111**:82–95.
- 2234 Thurlow LR, Thomas VC, Fleming SD *et al.* *Enterococcus faecalis* capsular polysaccharide  
2235 serotypes C and D and their contributions to host innate immune evasion. *Infect Immun*  
2236 2009;**77**:5551–7.
- 2237 Torres VJ, Pishchany G, Humayun M *et al.* *Staphylococcus aureus* IsdB is a hemoglobin  
2238 receptor required for heme iron utilization. *J Bacteriol* 2006;**188**:8421–9.
- 2239 Tsao N, Tsai WH, Lin YS *et al.* Streptococcal pyrogenic exotoxin B cleaves properdin and  
2240 inhibits complement-mediated opsonophagocytosis. *Biochem Biophys Res Commun*  
2241 2006;**339**:779–84.
- 2242 Tseng YT, Wang SW, Kim KS *et al.* Nlpl facilitates deposition of C4BP on *Escherichia coli* by  
2243 blocking classical complement-mediated killing, which results in high-level bacteremia.  
2244 *Infect Immun* 2012;**80**:3669–78.
- 2245 Tuffs SW, Goncheva MI, Xu SX *et al.* Superantigens promote *Staphylococcus aureus*  
2246 bloodstream infection by eliciting pathogenic interferon-gamma production. *Proc Natl*  
2247 *Acad Sci U S A* 2022;**119**:e2115987119.
- 2248 Tzeng YL, Kahler CM, Zhang X *et al.* MisR/MisS two-component regulon in *Neisseria*  
2249 *meningitidis*. *Infect Immun* 2008;**76**:704–16.
- 2250 Uchiyama S, Sun J, Fukahori K *et al.* Dual actions of group B *Streptococcus* capsular sialic  
2251 acid provide resistance to platelet-mediated antimicrobial killing. *Proceedings of the*  
2252 *National Academy of Sciences* 2019;**116**:7465–70.
- 2253 Uria MJ, Zhang Q, Li Y *et al.* A generic mechanism in *Neisseria meningitidis* for enhanced

2254 resistance against bactericidal antibodies. *Journal of Experimental Medicine*  
2255 2008;**205**:1423–34.

2256 Valdes KM, Sundar GS, Vega LA *et al.* The *fruRBA* operon is necessary for group A  
2257 streptococcal growth in fructose and for resistance to neutrophil killing during growth in  
2258 whole human blood. *Infect Immun* 2016;**84**:1016–31.

2259 Valentino MD, Foulston L, Sadaka A *et al.* Genes contributing to *Staphylococcus aureus* fitness  
2260 in abscess- and infection-related ecologies. *mBio* 2014;**5**:e01729-14.

2261 Vanaporn M, Wand M, Michell SL *et al.* Superoxide dismutase C is required for intracellular  
2262 survival and virulence of *Burkholderia pseudomallei*. *Microbiology (N Y)* 2011;**157**:2392–  
2263 400.

2264 Vance RE, Rietsch A, Mekalanos JJ. Role of the type III secreted exoenzymes S, T, and Y in  
2265 systemic spread of *Pseudomonas aeruginosa* PAO1 *in vivo*. *Infect Immun* 2005;**73**:1706–  
2266 13.

2267 van Hensbergen VP, Mover E, de Maat V *et al.* Streptococcal lancefield polysaccharides are  
2268 critical cell wall determinants for human group IIA secreted phospholipase A2 to exert its  
2269 bactericidal effects. *PLoS Pathog* 2018;**14**:e1007348.

2270 Veyrier FJ, Boneca IG, Cellier MF *et al.* A novel metal transporter mediating manganese export  
2271 (MntX) regulates the Mn to Fe intracellular ratio and *Neisseria meningitidis* virulence.  
2272 *PLoS Pathog* 2011;**7**:1002261.

2273 Vorobjeva N V., Chernyak B V. NETosis: molecular mechanisms, role in physiology and  
2274 pathology. *Biochemistry* 2020;**85**:1178–90.

2275 Voyich JM, Vuong C, DeWald M *et al.* The SaeR/S gene regulatory system is essential for  
2276 innate immune evasion by *Staphylococcus aureus*. *Journal of Infectious Diseases*  
2277 2009;**199**:1698–706.

2278 Waite RD, Struthers JK, Dowson CG. Spontaneous sequence duplication within an open  
2279 reading frame of the pneumococcal type 3 capsule locus causes high-frequency phase  
2280 variation. *Mol Microbiol* 2001;**42**:1223–32.

2281 Walker JN, Crosby HA, Spaulding AR *et al.* The *Staphylococcus aureus* ArIRS two-component

2282 system is a novel regulator of agglutination and pathogenesis. *PLoS Pathog*  
2283 2013;**9**:e1003819.

2284 Walport MJ. Complement. First of two parts. *N Engl J Med* 2001;**344**:1058–66.

2285 Wang R, Braughton KR, Kretschmer D *et al.* Identification of novel cytolytic peptides as key  
2286 virulence determinants for community-associated MRSA. *Nat Med* 2007;**13**:1510–4.

2287 Wang YC, Shih SM, Chen YT *et al.* Clinical and economic impact of intensive care unit-  
2288 acquired bloodstream infections in Taiwan: a nationwide population-based retrospective  
2289 cohort study. *BMJ Open* 2020;**10**:e037484.

2290 Ware D, Jiang Y, Lin W *et al.* Involvement of *potD* in *Streptococcus pneumoniae* polyamine  
2291 transport and pathogenesis. *Infect Immun* 2006;**74**:352–61.

2292 Wartha F, Beiter K, Albiger B *et al.* Capsule and d-alanylated lipoteichoic acids protect  
2293 *Streptococcus pneumoniae* against neutrophil extracellular traps. *Cell Microbiol*  
2294 2007;**9**:1162–71.

2295 Watts A, Ke D, Wang Q *et al.* *Staphylococcus aureus* strains that express serotype 5 or  
2296 serotype 8 capsular polysaccharides differ in virulence. *Infect Immun* 2005;**73**:3502–11.

2297 Weakland DR, Smith SN, Bell B *et al.* The *Serratia marcescens* siderophore serratiochelin is  
2298 necessary for full virulence during bloodstream infection. *Infect Immun* 2020;**88**:e00117-  
2299 20.

2300 Weber BS, De Jong AM, Guo ABY *et al.* Genetic and chemical screening in human blood  
2301 serum reveals unique antibacterial targets and compounds against *Klebsiella*  
2302 *pneumoniae*. *Cell Rep* 2020;**32**:107927.

2303 Weidenmaier C, Peschel A, Kempf VAJ *et al.* DltABCD- and MprF-mediated cell envelope  
2304 modifications of *Staphylococcus aureus* confer resistance to platelet microbicidal proteins  
2305 and contribute to virulence in a rabbit endocarditis model. *Infect Immun* 2005;**73**:8033–8.

2306 Wilks KE, Dunn KLR, Farrant JL *et al.* Periplasmic superoxide dismutase in meningococcal  
2307 pathogenicity. *Infect Immun* 1998;**66**:213.

2308 Will WR, Brzovic P, Trong I Le *et al.* The evolution of SlyA/RovA transcription factors from  
2309 repressors to counter silencers in *Enterobacteriaceae*. *mBio* 2019;**10**:e00009-19.

- 2310 Wilson RP, Winter SE, Spees AM *et al.* The Vi capsular polysaccharide prevents complement  
2311 receptor 3-mediated clearance of *Salmonella enterica* serotype Typhi. *Infect Immun*  
2312 2011;**79**:830–7.
- 2313 Woehl JL, Stapels DAC, Garcia BL *et al.* The extracellular adherence protein from  
2314 *Staphylococcus aureus* inhibits the classical and lectin pathways of complement by  
2315 blocking formation of the C3 proconvertase. *Journal of Immunology* 2014;**193**:6161–71.
- 2316 Wong SMS, St. Michael F, Cox A *et al.* ArcA-regulated glycosyltransferase Lic2B promotes  
2317 complement evasion and pathogenesis of nontypeable *Haemophilus influenzae*. *Infect*  
2318 *Immun* 2011;**79**:1971–83.
- 2319 Wooster DG, Maruvada R, Blom AM *et al.* Logarithmic phase *Escherichia coli* K1 efficiently  
2320 avoids serum killing by promoting C4BP-mediated C3b and C4b degradation.  
2321 *Immunology* 2006;**117**:482–93.
- 2322 Van Der Woude MW, Bäumlér AJ. Phase and antigenic variation in bacteria. *Clin Microbiol*  
2323 *Rev* 2004;**17**:581.
- 2324 Xayarath B, Marquis H, Port GC *et al.* *Listeria monocytogenes* CtaP is a multifunctional  
2325 cysteine transport-associated protein required for bacterial pathogenesis. *Mol Microbiol*  
2326 2009;**74**:956–73.
- 2327 Xu J, Zheng C, Cao M *et al.* The manganese efflux system MntE contributes to the virulence  
2328 of *Streptococcus suis* serotype 2. *Microb Pathog* 2017;**110**:23–30.
- 2329 Xu L, Wang M, Yuan J *et al.* The KbvR regulator contributes to capsule production, outer  
2330 membrane protein biosynthesis, antiphagocytosis, and virulence in *Klebsiella*  
2331 *pneumoniae*. *Infect Immun* 2021;**89**:e00016-21.
- 2332 Xu Y, Singh K V., Qin X *et al.* Analysis of a gene cluster of *Enterococcus faecalis* involved in  
2333 polysaccharide biosynthesis. *Infect Immun* 2000;**68**:815–23.
- 2334 Yeaman MR. Platelets: at the nexus of antimicrobial defence. *Nat Rev Microbiol* 2014;**12**:426–  
2335 37.
- 2336 Yoon H, McDermott JE, Porwollik S *et al.* Coordinated regulation of virulence during systemic  
2337 infection of *Salmonella enterica* Serovar Typhimurium. *PLoS Pathog* 2009;**5**:1000306.

2338 Zaharik ML, Cullen VL, Fung AM *et al.* The *Salmonella enterica* serovar Typhimurium divalent  
2339 cation transport systems MntH and SitABCD are essential for virulence in an  
2340 Nramp1G169 murine typhoid model. *Infect Immun* 2004;**72**:5522–5.

2341 Zhang L, Jacobsson K, Vasi J *et al.* A second IgG-binding protein in *Staphylococcus aureus*.  
2342 *Microbiology (N Y)* 1998;**144**:985–91.

2343 Zhang LF, Lepenies B, Nakamae S *et al.* The Vi capsular polysaccharide of *Salmonella* Typhi  
2344 promotes macrophage phagocytosis by binding the human C-type lectin DC-SIGN. *mBio*  
2345 2022;**13**.

2346 Zhang X, de Maat V, Guzmán Prieto AM *et al.* RNA-seq and Tn-seq reveal fitness determinants  
2347 of vancomycin-resistant *Enterococcus faecium* during growth in human serum. *BMC*  
2348 *Genomics* 2017;**18**:893.

2349 Zhu B, Green SP, Ge X *et al.* Genome-wide identification of *Streptococcus sanguinis* fitness  
2350 genes in human serum and discovery of potential selective drug targets. *Mol Microbiol*  
2351 2021;**115**:658–71.

2352 Zhu L, Yerramilli P, Pruitt L *et al.* Genome-wide assessment of *Streptococcus agalactiae* genes  
2353 required for survival in human whole blood and plasma. *Infect Immun* 2020;**88**:e00357-  
2354 20.

2355 Zipfel PF, Würzner R, Skerka C. Complement evasion of pathogens: common strategies are  
2356 shared by diverse organisms. *Mol Immunol* 2007;**44**:3850–7.

2357 Zou Y, Feng S, Xu C *et al.* The role of *galU* and *galE* of *Haemophilus parasuis* SC096 in serum  
2358 resistance and biofilm formation. *Vet Microbiol* 2013;**162**:278–84.

2359

2360



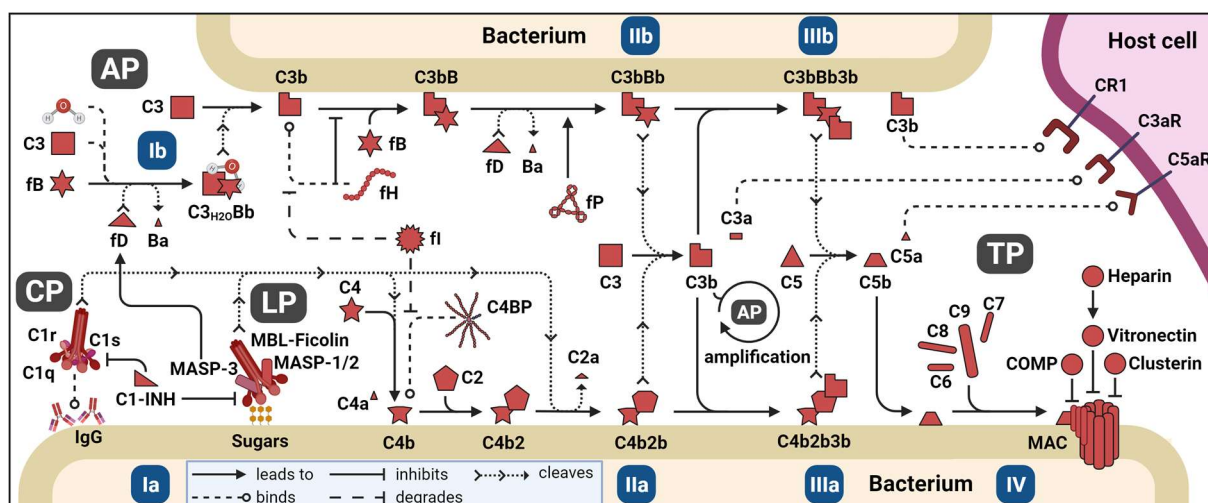

Figure 1.

2362

2363 **Figure 1.** The complement pathways. The classical pathway (CP) and lectin pathway (LP) are activated by binding to immunoglobulins and carbohydrate patterns, respectively

2364 (Ia). The alternative pathway (AP) is activated by the soluble C3 convertase  $C3H_2OBb$

2365 (Ib) or serves as amplification loop for the three pathways. The downstream cascades both

2366 lead to the formation of C3 convertases, converting C3 in C3a and C3b: C4b2b for the CP

2367 and LP (IIa) and C3bBb for the AP (IIb). Enrichment in C3b leads to the formation of C5

2368 convertases, converting C5 in C5a and C5b: C4b2b3b for the CP and LP (IIIa) and

2369 C3bBb3b for the AP (IIIb). C5b deposition activates the terminal pathway (TP) consisting

2370 in C6-C9 recruitment and membrane attack complex formation (IV). Abbreviations: C1-

2371 INH: C1-inhibitor. C3aR: C3a receptor. C4BP: C4-binding protein. C5aR: C5a receptor.

2372 COMP: cartilage oligomeric matrix protein. CR1: complement receptor 1. fB: factor B. fD:

2373 factor D. fH: factor H. fI: factor I. fP: factor P (properdin). IgG: immunoglobulin G. MAC:

2374 membrane attack complex. MASP: mannose-binding lectin-associated protease.

2375 MBL: mannose-binding lectin.

2377

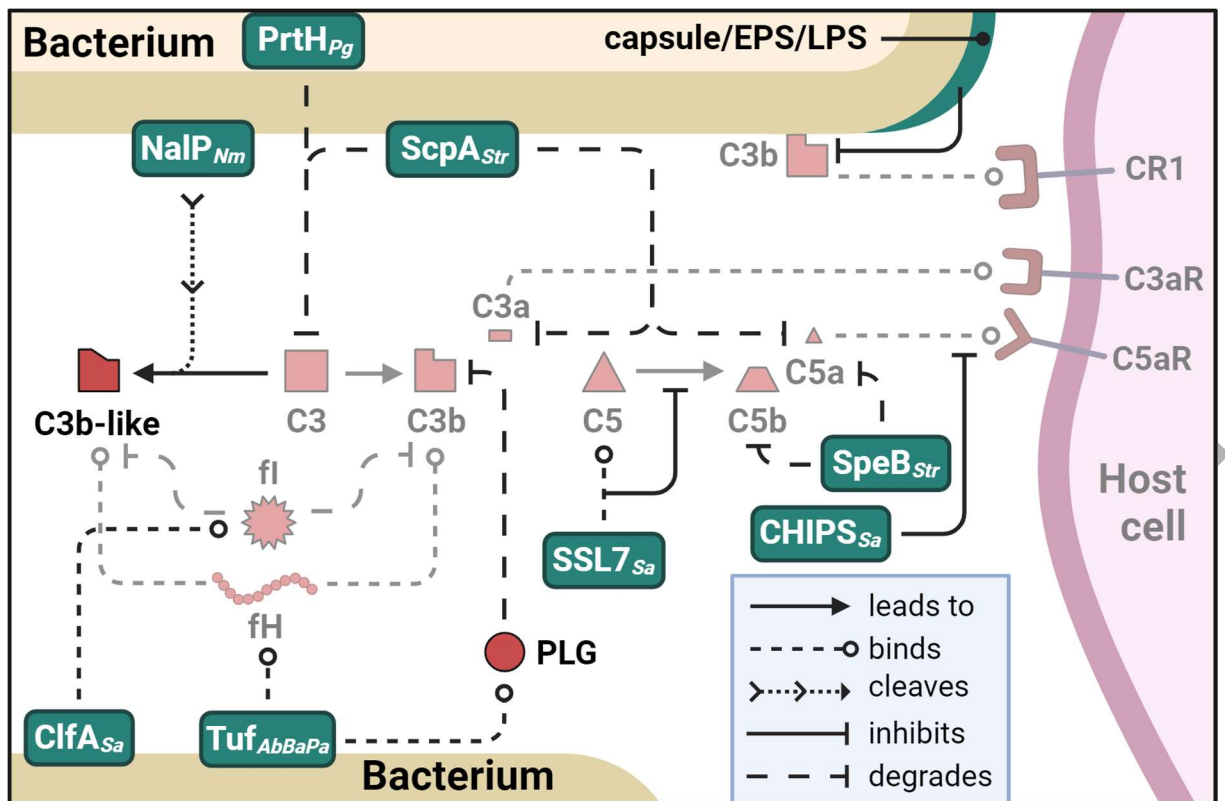

Figure 2.

2379

2380

2381

2382

2383

2384

2385

2386

2387

**Figure 2.** Examples of bacterial factors (green) targeting common components of the complement pathways (red). Factors involved in host subversion are displayed at the foreground. Bacterial species: *Ab*: *Acinetobacter baumannii*. *Ba*: *Bacillus anthracis*. *Nm*: *Neisseria meningitidis*. *Pa*: *Pseudomonas aeruginosa*. *Pg*: *Porphyromonas gingivalis*. *Sa*: *Staphylococcus aureus*. *Str*: *Streptococcus* species. Abbreviations: C3aR: C3a receptor. C5aR: C5a receptor. CR1: complement receptor 1. EPS: exopolysaccharide. fH: factor H. fl: factor I. LPS: lipopolysaccharide. PLG: plasminogen.

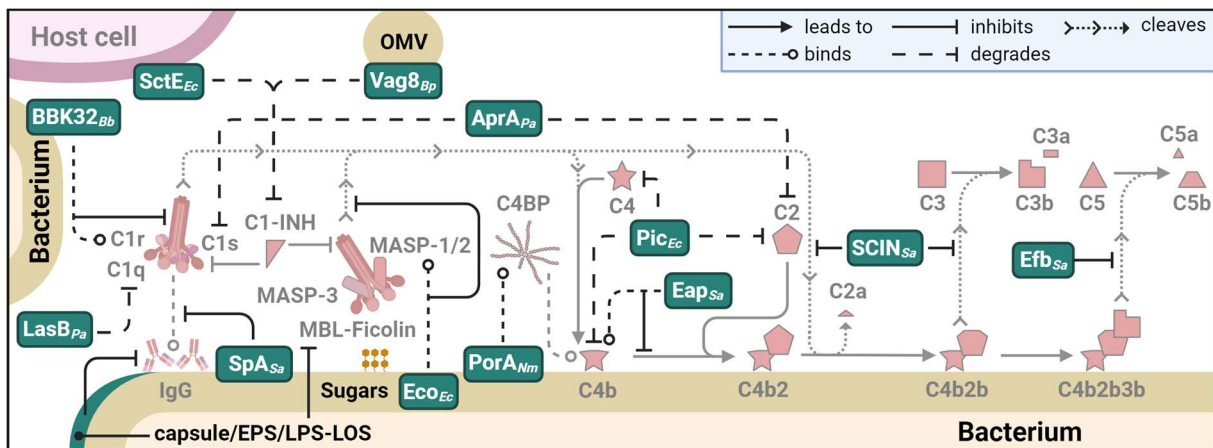

Figure 3.

2389

2390 **Figure 3.** Examples of bacterial factors (green) targeting host components (red) of the  
 2391 classical and lectin pathways. Factors involved in host subversion are displayed at the  
 2392 foreground. Bacterial species: *Bb*: *Borrelia burgdorferi*. *Bp*: *Bordetella pertussis*. *Ec*:  
 2393 *Escherichia coli*. *Nm*: *Neisseria meningitidis*. *Pa*: *Pseudomonas aeruginosa*. *Sa*:  
 2394 *Staphylococcus aureus*. Abbreviations: C4BP: C4-binding protein. EPS:  
 2395 exopolysaccharide. IgG: immunoglobulin G. LOS: lipooligosaccharide. LPS:  
 2396 lipopolysaccharide. MASP: mannan-binding lectin-associated protease. MBL:  
 2397 mannan-binding lectin. OMV: outer membrane vesicle.

2398

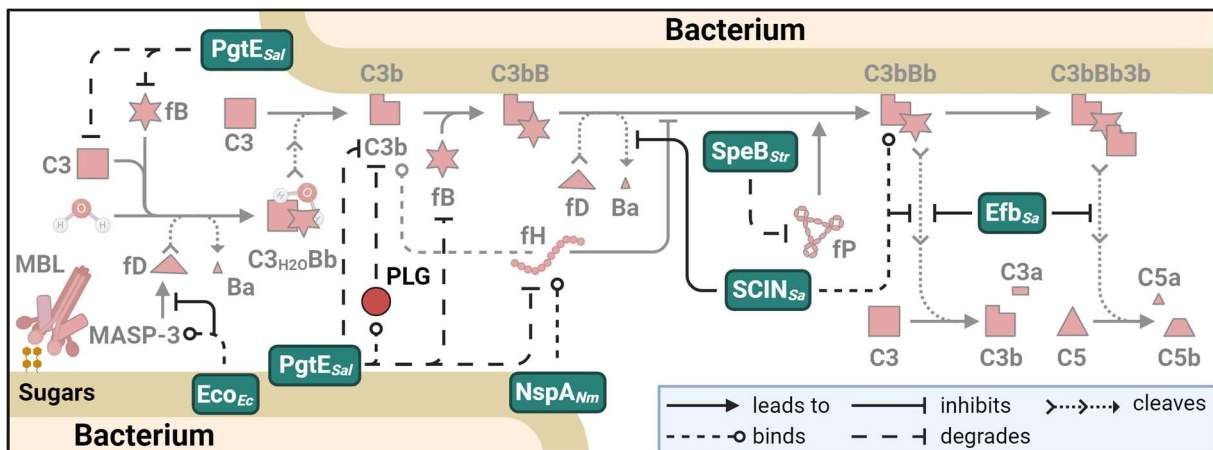

Figure 4.

2400

2401 **Figure 4.** Examples of bacterial factors (green) targeting host components (red) of  
 2402 the alternative pathway. Factors involved in host subversion are displayed at the  
 2403 foreground. Bacterial species: *Nm*: *Neisseria meningitidis*. *Sa*: *Staphylococcus aureus*.  
 2404 *Sal*: *Salmonella* species. *Str*: *Streptococcus* species. Abbreviations: fB: factor B. fD: factor  
 2405 D. fH: factor H. fP: factor P (properdin). MASP: mannose-binding lectin-associated  
 2406 protease. MBL: mannose-binding lectin. PLG: plasminogen.

2407

ORIGINAL UNEDITED MANUSCRIPT

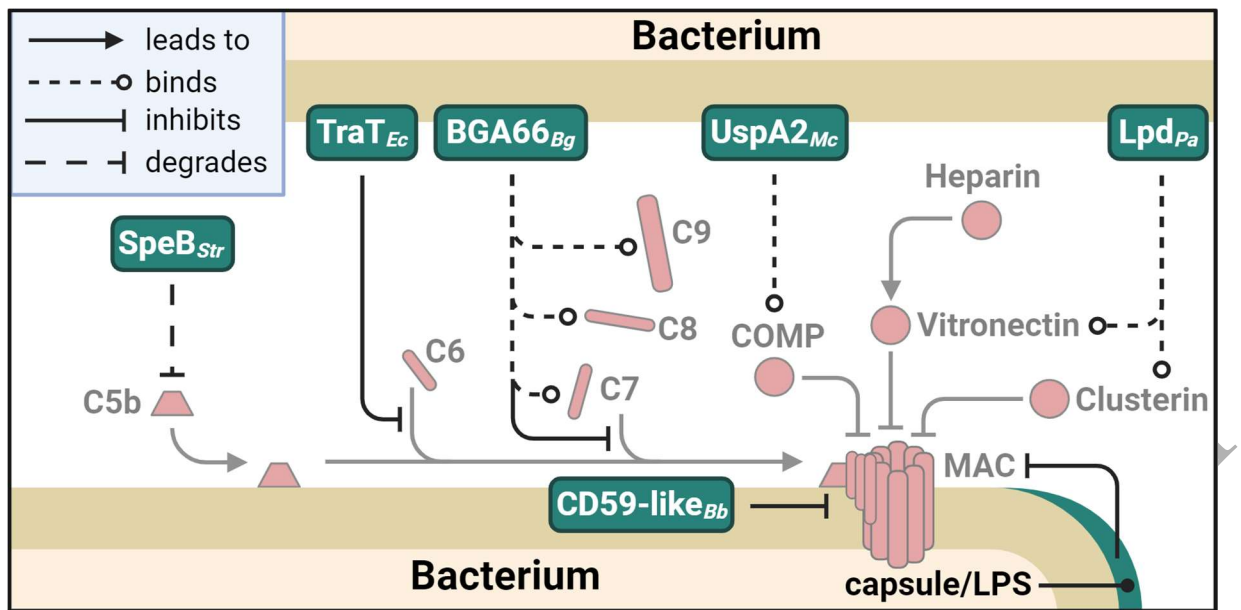

Figure 5.

2409

2410

**Figure 5.** Examples of bacterial factors (green) targeting host components (red) of the terminal pathway. Factors involved in host subversion are displayed at the foreground.

2411

2412

Bacterial species: *Bb*: *Borrelia burgdorferi*. *Bg*: *Borrelia garinii*. *Ec*: *Escherichia coli*. *Mc*: *Moraxella catarrhalis*. *Pa*: *Pseudomonas aeruginosa*. *Str*: *Streptococcus* species.

2413

2414

Abbreviations: COMP: cartilage oligomeric matrix protein. LPS: lipopolysaccharide. MAC:

2415

membrane attack complex.

2416

ORIGINAL UNEDITED MANUSCRIPT

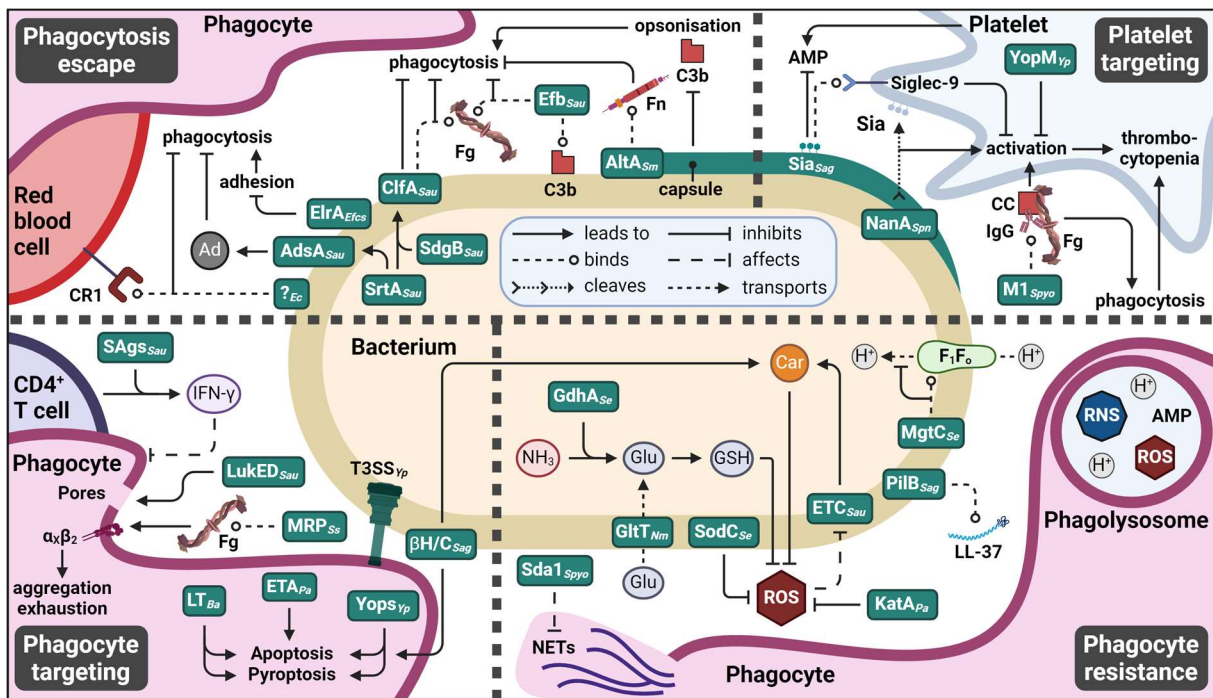

Figure 6.

2418

2419 **Figure 6.** Examples of bacterial factors (green) subverting host cell defenses in the  
 2420 blood. Bacterial species: *Ba*: *Bacillus anthracis*. *Ec*: *Escherichia coli*. *Efc*: *Enterococcus*  
 2421 *faecalis*. *Nm*: *Neisseria meningitidis*. *Pa*: *Pseudomonas aeruginosa*. *Sag*: *Streptococcus*  
 2422 *agalactiae*. *Sau*: *Staphylococcus aureus*. *Se*: *Salmonella enterica*. *Sm*: *Streptococcus*  
 2423 *mutans*. *Spn*: *Streptococcus pneumoniae*. *Spyo*: *Streptococcus pyogenes*. *Ss*:  
 2424 *Streptococcus suis*. *Yp*: *Yersinia pestis*. Abbreviations: Ad: adenosine. AMP: antimicrobial  
 2425 peptide. Car: carotenoid. CC: complement components. CR1: complement receptor 1.  
 2426 Fg: fibrinogen. Fn: fibronectin. Glu: glutamate. GSH: glutathione. IgG: immunoglobulin G.  
 2427 NET: neutrophil extracellular trap. RNS: reactive nitrogen species. ROS: reactive oxygen  
 2428 species. Sia: sialic acid. T3SS: type 3 secretion system.

2429



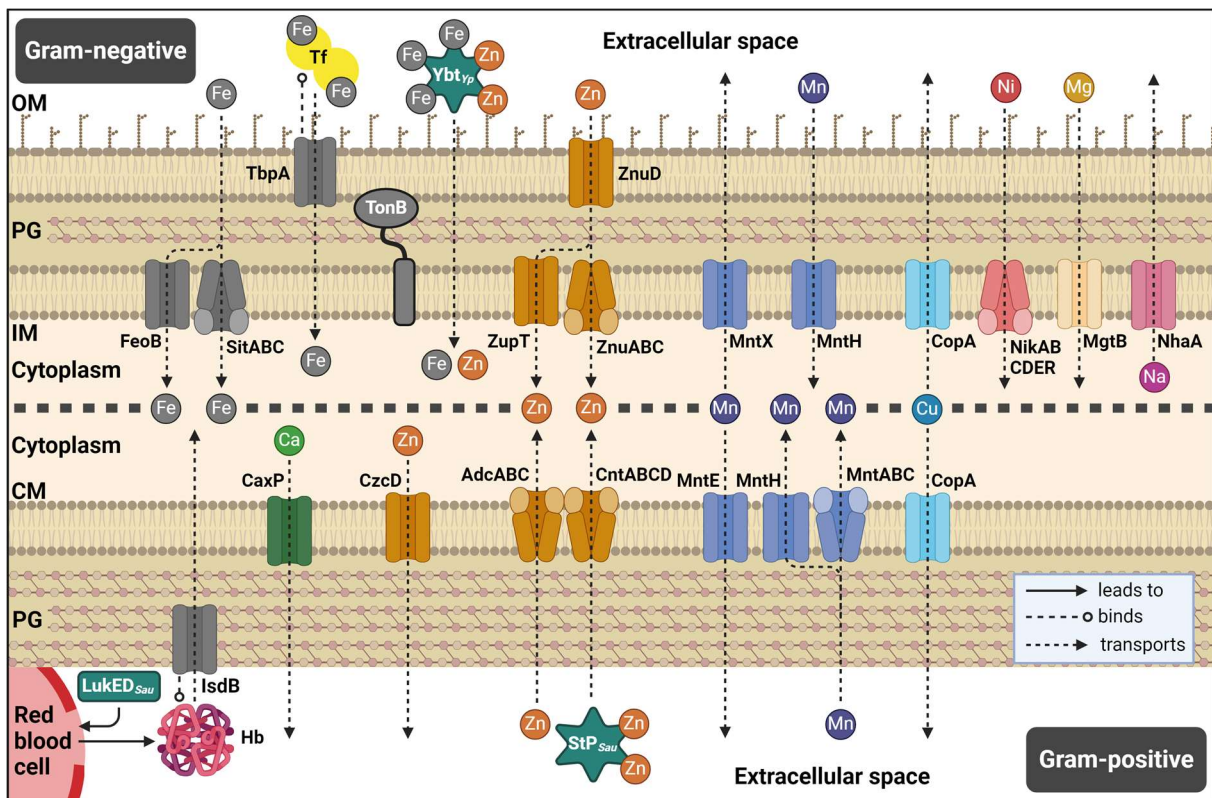

Figure 7.

2431

2432 **Figure 7.** Examples of bacterial factors subverting nutritional immunity in the blood.2433 Bacterial species: *Sau*: *Staphylococcus aureus*. *Yp*: *Yersinia pestis*. Metals: Ca: calcium.

2434 Cu: copper. Fe: iron. Mg: magnesium. Mn: manganese. Na: sodium. Ni: nickel. Zn: zinc.

2435 Abbreviations: CM: cytoplasmic membrane. Hb: hemoglobin. IM: inner membrane. OM:

2436 outer membrane. PG: peptidoglycan. Tf: transferrin.

2437

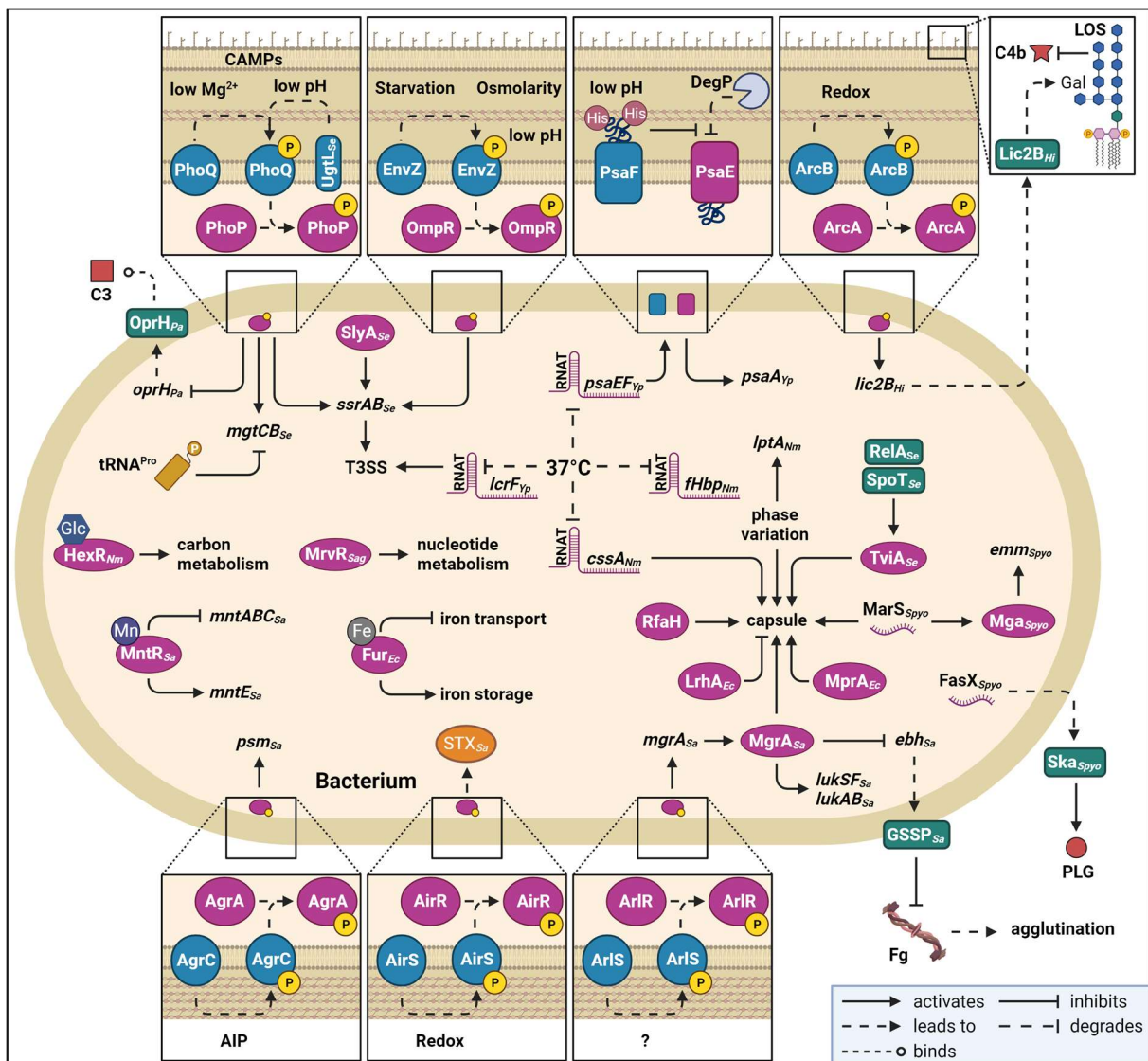

Figure 8.

2439

2440

2441

2442

2443

2444

2445

2446

2447

2448

**Figure 8.** Examples of bacterial regulatory mechanisms involved in adaptation and survival in blood. Regulators are in purple, secondary factors helping in regulation are in blue and bacterial effectors are in green. Bacterial species: *Ec*: *Escherichia coli*. *Hi*: *Haemophilus influenzae*. *Nm*: *Neisseria meningitidis*. *Pa*: *Pseudomonas aeruginosa*. *Sag*: *Streptococcus agalactiae*. *Sau*: *Staphylococcus aureus*. *Se*: *Salmonella enterica*. *Spyo*: *Streptococcus pyogenes*. *Yp*: *Yersinia pestis*. Abbreviations: AIP: auto-inducing peptide. AMP: antimicrobial peptide. Fe: iron. Fg: fibrinogen. Glc: glucose. His: histidine. LOS: lipooligosaccharide. Mn: manganese. P: phosphate. PLG: plasminogen. RNAT: RNA thermometer. STX: staphyloxantin.



2449

2450 **Box 1. The complement system**

2451 The complement cascade can be activated by three different pathways upon bloodstream  
2452 infection: the classical pathway (CP), the lectin pathway (LP) and the alternative pathway  
2453 (AP). The three pathways lead to cleavage of C3 and C5 components and activation of the  
2454 terminal pathway (TP) (Figure 1).

2455 The CP is activated by binding of the C1 complex, composed of the scaffold of C1q  
2456 subunits and the C1s and C1r proteases, to immunoglobulins (Ig) bound to a bacterial antigen  
2457 or alternatively by binding of C1 to the C-reactive protein (CRP), recognizing phosphocholine  
2458 on bacterial surfaces. The LP is activated by mannose-binding lectin (MBL) and ficolins,  
2459 complexed with mannose-binding lectin-associated proteases 1 and 2 (MASP-1 and MASP-  
2460 2), and bound to specific target carbohydrates on bacterial surfaces (Figure 1.Ia). Both  
2461 complexes recruit and cleave C4 then C2 components into C4a, C4b, C2a and C2b  
2462 components, forming the C3 convertase C4b2b (formerly known as C4b2a). C4b2b cleaves  
2463 C3 in C3a and C3b (Figure 1.IIa), when C4b is not degraded by the coordinated action of  
2464 C4b-binding protein (C4BP) and the factor I protease (fI). The AP is first activated by  
2465 deposition of C3b and factor B (fB) on bacterial surface. The deposited C3b is a product of  
2466 the soluble C3 convertase, composed of C3 bound to H<sub>2</sub>O and factor B (Figure 1.Ib), or of C3  
2467 convertases from the other pathways, the AP also serving as an amplification loop. C3b  
2468 bound to factor B and stabilized by properdin (factor P, fP) forms a C3 convertase, C3bBb (or  
2469 C3bBbP) (Figure 1 IIb). Factor I can cleave C3b in inactive C3b (iC3b), an opsonin binding to  
2470 complement receptor 3 (CR3). It was recently shown that MASP-3 is the activator of factor D  
2471 (fD), linking the LP to the AP (Hayashi *et al.* 2019). FD in turn activates the AP by cleaving  
2472 factor B, generating C3(H<sub>2</sub>O)Bb and C3bBb. Factor H (fH) and factor I prevent activation of  
2473 the AP.

2474 C3 convertases cleave C3 in C3a and C3b. C3a is a multifunctional peptide required for  
2475 chemotaxis, which binds to C3a receptor (C3aR), and activates immune cells. C3b is an  
2476 opsonin that binds to complement receptor 1 (CR1) and is essential for the propagation of

2477 the complement cascade. C3b binds to all C3 convertases, forming C5 convertases C4b2b3b  
2478 (CP/LP) (Figure 1.IIIa) and C3bBb3b (AP) (Figure 1.IIIb), which cleave C5 in C5a and C5b.  
2479 C5a is a chemoattractant for immune cells. Upon binding to the bacterial surface, C5b triggers  
2480 the TP. C5b deposition recruits C6, C7, C8 and C9 that insert and polymerize in the bacterial  
2481 membrane, forming the membrane-attack complex (MAC), a pore forming complex resulting  
2482 in bacterial lysis (Figure 1.IV). MAC assembly can be negatively regulated by heparin-binding  
2483 vitronectin, clusterin, CD59 or the cartilage oligomeric matrix protein (COMP). For  
2484 comprehensive views of the structure, function and dynamics of the complement system, the  
2485 reader is referred to previous reviews (Walport 2001; Ricklin *et al.* 2010; Schatz-Jakobsen *et*  
2486 *al.* 2016; Mastellos *et al.*, 2023).

2487

2488

2489

2490

ORIGINAL UNEDITED MANUSCRIPT

2491

2492 **Box 2. Transposon-based mutational screens**

2493 Transposon-based mutational screen approaches rely on mutant libraries generated by  
2494 random transposition in the genome. These pooled libraries can then be used to screen  
2495 mutants for various phenotypes such as resistance to serum or survival in blood, by  
2496 measuring the differences in mutant abundance between the input and the output. Several  
2497 techniques have been developed over the years:

- 2498 • **STM:** The first signature-tagged mutagenesis (STM) was developed in 1995. It  
2499 consisted of unique nucleotidic tags inserted in the transposon. Depletion of specific  
2500 mutants in a pool was revealed by hybridization arrays (Hensel *et al.* 1995).
- 2501 • **TraSH:** To circumvent the small size of pools in STM, another technique called  
2502 transposon site hybridization (TraSH) was developed. It is based on genomic DNA  
2503 hybridization on microarray (Sasseti *et al.* 2001).
- 2504 • **TIS:** Higher throughput is now achieved by next-generation sequencing (NGS), which  
2505 opened new possibilities in transposon screening and led to the development of  
2506 transposon insertion sequencing (TIS) falling into four different methods: transposon  
2507 sequencing (**Tn-seq**), transposon-directed insertion sequencing (**TraDIS**), insertion  
2508 sequencing (**INSeq**) and high-throughput insertion tracking by deep sequencing  
2509 (**HITS**) (Cain *et al.* 2020).

2510 These screens have been widely used to discover new factors involved in bacteremia of  
2511 the most clinically relevant bacteria such as *S. aureus* (Mei *et al.* 1997; Coulter *et al.* 1998;  
2512 Benton *et al.* 2004; Christiansen *et al.* 2014; Valentino *et al.* 2014; Oogai *et al.* 2016; Groma  
2513 *et al.* 2020) or *E. coli* (Phan *et al.* 2013; Subashchandrabose *et al.* 2013; McCarthy *et al.*  
2514 2018; Ma *et al.* 2021) as well as other bacteria associated with bloodstream infection such as  
2515 *A. baumannii* (Subashchandrabose *et al.* 2016; Sanchez-Larrayoz *et al.* 2017), *Citrobacter*  
2516 *freundii* (Anderson *et al.* 2018), *E. faecium* (Zhang *et al.* 2017), *H. influenzae* (Langereis and  
2517 Weiser 2014), *K. pneumoniae* (Short *et al.* 2020; Holmes *et al.* 2022), *Leptospira interrogans*  
2518 (Lourdault *et al.* 2016), *N. meningitidis* (Sun *et al.* 2000; Geoffroy *et al.* 2003; Mendum *et al.*

2519 2011; Capel *et al.* 2017), *Pasteurella multocida* (Fuller *et al.* 2000), *Proteus mirabilis*  
2520 (*Armbruster et al.* 2019), *P. aeruginosa* (Janet-Maitre *et al.* 2023), *S. enterica* (Hensel *et al.*  
2521 1995; Chaudhuri *et al.* 2009), *S. marcescens* (Anderson *et al.* 2017), *S. agalactiae* (Hooven  
2522 *et al.* 2018; Zhu *et al.* 2020; Dammann *et al.* 2021), *Streptococcus equi* (Charbonneau *et al.*  
2523 2020), *S. pneumoniae* (Polissi *et al.* 1998; Mann *et al.* 2012), *S. pyogenes* (Le Breton *et al.*  
2524 2013; van Hensbergen *et al.* 2018), *S. suis* (Arenas *et al.* 2020), *Y. pestis* (Palace *et al.* 2014)  
2525 or *Y. pseudotuberculosis* (Crimmins *et al.* 2012). Additionally, a genetic screen using a library  
2526 of *K. pneumoniae* transposon mutant recently identified factors required for bacterial survival  
2527 in human serum (Weber *et al.* 2020). The mode of action of most of these factors remains to  
2528 be deciphered.

2529

ORIGINAL UNEDITED MANUSCRIPT