



HAL
open science

Effect of nirsevimab on hospitalisations for respiratory syncytial virus bronchiolitis in France, 2023–24: a modelling study

Antoine Brault, Isabelle Pontais, Vincent Enouf, Christine Debeuret, Emma Bloch, Juliette Paireau, Marie Anne Rameix-Welti, Michael White, Gaëlle Baudemont, Bruno Lina, et al.

► To cite this version:

Antoine Brault, Isabelle Pontais, Vincent Enouf, Christine Debeuret, Emma Bloch, et al.. Effect of nirsevimab on hospitalisations for respiratory syncytial virus bronchiolitis in France, 2023–24: a modelling study. *The Lancet Child & Adolescent Health*, 2024, 8 (10), pp.721-729. 10.1016/S2352-4642(24)00143-3. pasteur-04501465v2

HAL Id: pasteur-04501465

<https://pasteur.hal.science/pasteur-04501465v2>

Submitted on 18 Nov 2024

HAL is a multi-disciplinary open access archive for the deposit and dissemination of scientific research documents, whether they are published or not. The documents may come from teaching and research institutions in France or abroad, or from public or private research centers.

L'archive ouverte pluridisciplinaire **HAL**, est destinée au dépôt et à la diffusion de documents scientifiques de niveau recherche, publiés ou non, émanant des établissements d'enseignement et de recherche français ou étrangers, des laboratoires publics ou privés.



Distributed under a Creative Commons Attribution - NonCommercial 4.0 International License

Effect of nirsevimab on hospitalisations for respiratory syncytial virus bronchiolitis in France, 2023–24: a modelling study

Antoine Brault¹, PhD; Isabelle Pontais², PhD; Vincent Enouf^{3,4,5}, PhD; Christine Debeuret⁶, PhD; Emma Bloch⁷, MSc; Juliette Paireau^{1,8}, PhD; Prof Marie-Anne Rameix-Welti^{3,4}, PhD; Michael White⁷, PhD; Gaëlle Baudemont⁷, MsC; Prof Bruno Lina⁹, PhD; Isabelle Parent du Châtelet⁸, MD; Jean-Sébastien Casalegno⁹, MD; Sophie Vaux⁸, PharmD; Prof Simon Cauchemez¹, PhD

1. Mathematical Modelling of Infectious Diseases Unit, Institut Pasteur, Université Paris Cité, CNRS UMR 2000, Paris, France
2. Direction Appui, Traitements et Analyses de données, Santé publique France, Saint-Maurice, France
3. Molecular Mechanisms of Multiplication of Pneumovirus, Université Paris-Saclay-Versailles St. Quentin, Institut Pasteur, Université Paris Cité, UMR 1173 (2I), INSERM; Assistance Publique des Hôpitaux de Paris, Paris, France.
4. National Reference Center for Respiratory viruses, Université Paris Cité, Institut Pasteur, Paris, France
5. Mutualized Platform of Microbiology, Pasteur International Bioresources Network, Université Paris Cité, Institut Pasteur, Paris, France
6. Direction alerte et crise, établissement pharmaceutique, Santé publique France, Saint-Maurice, France
7. Infectious Disease Epidemiology and Analytics G5 Unit, Department of Global Health, Institut Pasteur, Université Paris-Cité, Paris, France
8. Direction des Maladies Infectieuses, Santé publique France, Saint-Maurice, France
9. Virology Laboratory, CNR des Virus des Infections Respiratoires, Institut des Agents Infectieux, Hôpital de la Croix Rouse, Hospices Civils de Lyon, Lyon, France

Corresponding author:

Simon Cauchemez

Mathematical Modelling of Infectious Diseases Unit, Institut Pasteur

28 rue du Dr Roux

75015 Paris, France

simon.cauchemez@pasteur.fr

This manuscript is the accepted version of the article published on August 26, 2024, in *The Lancet Child & Adolescent Health*, Volume 8, Issue 10, 721 - 729. The published version is available at <https://www.sciencedirect.com/science/article/pii/S2352464224001433> (DOI: 10.1016/S2352-4642(24)00143-3).

© 2024. This manuscript version is made available under the CC-BY-NC-ND 4.0 license <https://creativecommons.org/licenses/by-nc-nd/4.0/>

Summary

Background

Respiratory syncytial virus (RSV) is a major cause of hospitalisations and deaths among infants worldwide. France was one of the first countries to administer nirsevimab, a single-dose long-acting monoclonal antibody treatment to prevent lower respiratory tract infection caused by RSV. We aimed to assess real-world nirsevimab effectiveness and its impact in terms of hospitalisations averted.

Methods

We developed an age-structured deterministic model characterising RSV transmission as well as plausible scenarios for the administration of nirsevimab doses based on delivery data to maternity wards and community pharmacies. We retrospectively estimated nirsevimab effectiveness and the number of hospitalisations for RSV bronchiolitis following emergency room visits (HBER-RSV) averted in France (excluding overseas territories), by calibrating the model to hospital and virological surveillance data from mid-2017 to February 4, 2024, alongside serological data. To assess the robustness of our estimates, we conducted sensitivity analyses in which we modified our assumptions about the number of doses administered, the reconstruction of the number of HBER-RSV, the duration of maternal and post-infection immunity, and the number of contacts in children aged 0-2 months.

Findings

We estimated that nirsevimab administration prevented 5,800 (95% Credible Interval: 3,700-7,800) HBER-RSV, including 4,200 (2,900-5,600) among those aged 0-2 months, between September 15, 2023 and February 4, 2024. This corresponds to a 23% (16%-30%) reduction in the total number of HBER-RSV (35%, 25%-44%, among 0-2 months) compared to the scenario without administration. In our baseline scenario with 215,000 doses administered by January 31, 2024, the effectiveness of nirsevimab against HBER-RSV was

estimated at 73% (61%-84%), which corresponds to one HBER-RSV case prevented for every 39 (26-54) doses administered. In sensitivity analyses, estimated number of HBER-RSV averted, effectiveness and doses administered to avert one HBER-RSV varied between 5,100-6,300, 68%-76%, and 36-43, respectively.

Interpretation

With one hospitalisation averted for every 40 treated children, our study highlights the relevance of nirsevimab administration campaigns to reduce RSV-related hospital burden.

Funding

European Commission under the EU4Health programme 2021-2027 DURABLE, Laboratoire d'Excellence Integrative Biology of Emerging Infectious Diseases program and INCEPTION project.

Research in context

Evidence before this study

On May 2, 2024, we searched on PubMed all articles published after January 1, 2023, estimating the impact of nirsevimab or its effectiveness in real-world settings with the following search terms: “(nirsevimab OR Beyfortus) AND (impact OR effectiveness)”. We found 34 publications associated with this query. We excluded off-topic studies, clinical trials HARMONIE and MELODY measuring efficacy (not effectiveness in real-world settings), modelling studies that did not estimate effectiveness or impact of nirsevimab. We found five relevant studies. The effectiveness against RSV-related lower respiratory tract infections (LRTI) hospitalisations was estimated at 84% (77%-90%) using screening design and 70% (38%-86%) using test-negative design in Spain (López-Lacort et al. 2024); 89% (70%-96%) in a prospective cohort among 1,177 infants in Navarre (Spain) (Ezpeleta et al. 2024); 82% (66%-90%) in population-based longitudinal study among 10,259 infants in Galicia (Spain) (Ares-Gómez et al. 2024). Effectiveness against RSV-related hospitalisations was estimated at 90% (75%-96%) among 699 infants in the United States (Moline et al. 2024). Comparing the season 2023-2024 with previous ones, reductions in RSV-related hospitalisations of 38% in children under 5 years old and 68% in infants under 6 months old were observed in Luxembourg (Ernst et al. 2024). A 90% reduction of RSV-related LRTI hospitalisation was noted in Galicia (Ares-Gómez et al. 2024), where it was estimated that for every 25 (24–32) children receiving nirsevimab, one RSV-related LRTI hospitalisation was averted.

Added value of this study

Estimates of effectiveness and impact of nirsevimab are still emerging. This study offers a distinct methodology from existing research, analysing nationwide surveillance and treatment delivery data with mathematical models to estimate nirsevimab effectiveness and evaluating the population level impact of the treatment campaign on hospitalisations for RSV bronchiolitis (e.g. number of hospitalisations averted).

Implications of all the available evidence

All real-world studies, including our own, demonstrate an important effectiveness of nirsevimab in preventing RSV-related hospitalisations and reducing the hospital paediatric burden related with RSV. These findings are crucial for public health policy, highlighting the relevance of widespread nirsevimab immunisation campaigns. Further research will be needed to assess its effectiveness and impact over longer periods of time, in different populations, and geographic contexts.

Introduction

Respiratory syncytial virus (RSV) is a major cause of lower respiratory tract infections (LRTI) in young children.¹ Globally, it led to between 2.9 and 4.6 million hospitalisations and 100,000 deaths among children under the age of five in 2019. The burden of this disease disproportionately affects low- and middle-income countries, where 97% of these deaths occur. However, even in high-income countries, RSV constitutes an important healthcare challenge.^{2,3}

In France, RSV typically circulates in the winter months. The consequences of this widespread circulation are particularly observed in paediatric wards, which may necessitate substantial reorganisation to admit children requiring hospitalisation for bronchiolitis, a condition mostly induced by RSV.^{4,5} Following the emergence of SARS-CoV-2, RSV epidemic and hospitalisations for bronchiolitis have been severely disrupted.^{6,7}

In October 2022, the European Union granted approval for nirsevimab (Beyfortus®), a single-dose long-acting monoclonal antibody administered via intramuscular injection. It is designed for neonates and infants to prevent RSV LRTI during their first year of exposure. In clinical studies, the efficacy against hospitalisation for RSV LRTI was estimated between 77% (49%-89%) and 83% (68%-92%).^{8,9} In September 2023, France was one of the first countries to organise a national immunisation campaign with this preventive treatment.¹⁰ At the end of January 2024, about 232,000 doses had been delivered to maternity wards and community pharmacies. Given the limited availability of doses and high adherence to the treatment, priority was given to neonates in maternity wards.¹¹

Here, using a mathematical model, we leveraged France's early delivery of nirsevimab with the aim of measuring its impact on the dynamics of hospitalisations for RSV bronchiolitis following emergency room visits (HBER-RSV). Our model was retrospectively calibrated to French hospitalisation, virological and serological data up to February 4, 2024, *i.e.* parameters such as nirsevimab effectiveness against HBER-RSV were estimated through

solid statistical methodology identifying parameter values that maximised model adequacy to the data. In addition, the number of HBER-RSV averted was assessed by simulating counterfactual scenarios with no treatments.

Methods

Data sources and assumptions

We used several sets of data including syndromic surveillance data on hospitalisations for bronchiolitis, stratified by age; virological data from hospitalised patients; serological data; and information on the distribution and stock levels of nirsevimab doses in maternity hospitals and community pharmacies.

The French syndromic surveillance network of emergency rooms (OSCOUR®¹²), coordinated by Santé publique France, records daily numbers of hospitalisations with bronchiolitis following emergency room visits (HBER) per age group. The network has progressively grown: in 2022, 718 emergency rooms participated; 96.6% of emergency room visits in France were registered in OSCOUR®; and of these, 87.2% were coded with a diagnosis (compared to 696, 92.3% and 76.6% in 2017, respectively) (Table S1 appendix p. 3). To calculate the number of HBER in France (excluding overseas regions), we divided the number of HBER by an annual factor that is the product of the proportion of emergency room visits registered in OSCOUR and the number of emergency room visits coded in the system.^{13,14}

The number of RSV-related HBER (HBER-RSV) is unknown. We reconstructed the weekly number of HBER-RSV among infants aged 0-2 months, 3-5 months, 6-8 months, 9-11 months, and 12-23 months by combining data from the syndromic hospital surveillance (OSCOUR®) and virological surveillance. Virologically confirmed RSV case data were obtained from the hospital surveillance network (RENAL), mainly comprising University Hospital Centers (UHCs). This dataset lacks age stratification, and the subset of patients

tested for RSV does not exclusively include those diagnosed with bronchiolitis. Given that the peak of the RSV epidemic typically corresponds to the period with the highest incidence of RSV-related bronchiolitis, we assumed in our baseline scenario that the HBER-RSV peak corresponds to 90% of the HBER peak.¹⁵ Combining this hypothesis with other assumptions, we show (appendix p. 2) that for each age group and season (from week 34, typically starting August 17-23, to week 33 of the following year, typically ending August 16-22), HBER-RSV correspond to RSV cases in the RENAL network scaled by a season-dependent factor ensuring the HBER-RSV peak reaches 90% of the HBER peak.

Between February and August 2020, the SeroPed study,¹⁶ a cross-sectional serological survey, was carried out among patients admitted to French hospitals for reasons other than COVID-19 with 1,132 samples available for serological testing, including 275 from children under 10 years of age (Table S2 appendix p. 3). RSV IgG antibody levels were measured using a bead-based multiplex serological assay (appendix p. 3). 19 patients <12 months were excluded due to the potential confounding effect of rapidly declining maternal antibodies post-birth.

Nirsevimab administration in France officially started on September 15, 2023, with a focus on maternity wards. Two types of single dose formulations administered via intramuscular injection exist: 50 mg for infants weighing < 5 kg and 100mg for those weighing more. According to data collected by Santé publique France, a total of 232,000 doses of nirsevimab were delivered by January 31, 2024 (Figure S1 appendix p.4): 167,000 50 mg doses and 11,000 100 mg doses were delivered in maternity wards; community pharmacies received 54,000 100 mg doses. Based on stock statistics available in maternity wards (appendix p. 4), we estimated in our baseline scenario that approximately 215,000 doses of nirsevimab (74% of 50 mg doses and 26% of 100 mg doses) had been administered by January 31, 2024, with a sensitivity analysis of 205,000 and 220,000 doses. We presumed that neonates received 50 mg doses at birth, while infants aged 0-2 months and 3-5 months each received 50% of the 100 mg doses, respectively, with a constant number of doses

administered daily between September 15, 2023 and January 7, 2024. We assumed that the number of doses administered daily was twice lower between January 8 and 31, 2024 (after the intense epidemic period had passed) than between September 15, 2023 and January 7, 2024.

We did not have access to sex-specific or race/ethnicity data to inform the model. Ethical approval was not necessary since this study used routine surveillance data for which no patient consent was required.

Transmission model

We adapted a deterministic compartmental model previously employed for describing RSV transmission dynamics¹⁷⁻¹⁹ to assess the impact of nirsevimab administration (Figure 2 for a simplified flow diagram without age-structure, Figure S2 in appendix p. 4 for the complete flow diagram). The model is structured in 7 age groups: 0-2 months, 3-5 months, 6-8 months, 9-11 months, 12-23 months, 24-35 months, ≥ 36 months. It accounts for the ageing of individuals, with the rate of transition between age groups corresponding to the size of each age group (Figure S3 in appendix p. 7). An age-dependent rate was implemented to account for natural mortality and migrations.

We calculated the average number of daily contacts between age groups (Figure S4 in appendix p. 8) using the contact matrix provided in Mistry et al.²⁰ We assumed that all individuals aged <12 months had the same number of contacts with other age groups (appendix p. 7).

The population was partitioned in compartments M , S , I and R (Figure 2). A portion receives maternal immunity against RSV (M), which wanes after an average duration $1/\omega_M$ fixed to 2 months in the baseline scenario, leading to their transition to the susceptible state (S). Neonates not receiving maternal immunity are directly classified as susceptible. Upon infection by RSV, susceptible individuals become infectious (I) for an average duration $1/\gamma$ of

7 days¹⁸ after which they move to the temporarily immune compartment (R). Immunity lasts for an average duration of $1/\omega$ fixed to 9 months in the baseline scenario, after which individuals revert to susceptibility. The model accounts for reduced susceptibility following sequential infections, with susceptibility multiplied by a factor λ_1 fixed to 0.76 after the first infection and a factor $\lambda_2 \cdot \lambda_1$ fixed to 0.67 after the second infection.²¹

We hypothesised that the transmission rate varies seasonally (cosine function with minimum and maximum transmission rates estimated, peak timing fixed at 320 days), with an additional effect estimated for summer holidays (from July 1 to August 31). During the COVID-19 period, three estimated parameters captured the impact on the transmission rate of lockdowns, curfews, and periods with other protective measures (mask-wearing, physical distancing). Two estimated parameters measured potential changes in the transmission rate during the 2022-2023 and 2023-2024 seasons.

The probability of HBER-RSV upon RSV infection p_h is estimated with an exponential function decreasing with age up to 11 months; and an independent estimated parameter for the 12-23 months age group.

The population is also partitioned into individuals who have received nirsevimab and others. Individuals can receive nirsevimab at birth (50 mg doses), or when aged 0-5 months (100 mg doses). Individuals who received the treatment have the same susceptibility to infection, infectivity and duration of infectivity; but a probability of HBER-RSV upon RSV infection which is multiplied by a factor $1 - TE$, relative to those who did not, where TE is nirsevimab effectiveness against HBER-RSV estimated from calibration to the data. The mathematical model is detailed in appendix p. 4.

Model calibration

The model was initialised in January 1, 2005, with 1 infection per age group so that it reached a steady state before being compared to the data. It was calibrated jointly to the

reconstructed weekly HBER-RSV between August 2017-February 4, 2024 for age groups <24 months and our serological data (appendix p. 10). In a Bayesian framework, the posterior distribution of model parameters was explored by Markov chain Monte Carlo sampling. A comprehensive breakdown of fitted and fixed parameters, along with their corresponding priors, is provided in Table S3. In short, a total of 13 parameters were estimated: transmission parameters (n=8), hospitalisation probabilities (n=3), nirsevimab effectiveness and a dispersion parameter of the likelihood. The reduction of susceptibility after infection, the peak timing of the transmission rate, the different durations of immunity were fixed. We give the mean and 95% credible interval (CI) of the posterior distribution.

Impact assessment of nirsevimab

To estimate the number of HBER-RSV averted, we compared the number of HBER-RSV in the simulation scenario where nirsevimab is administered to the counterfactual scenario where it is not, sampling 1,000 epidemic trajectories for each scenario.

To assess the robustness of our estimations, we conducted 9 sensitivity analyses assuming:

- 1) 205,000 or 220,000 doses administered by January 31, 2024 (205,000 doses; 220,000 doses);
- 2) peak of HBER-RSV equal to 80% or 100% of the HBER peak (peak 80%; peak 100%);
- 3) peak of HBER-RSV equal to 90% of the HBER peak in 0-2 months and 3-5 months age groups and 80% in older age groups (peak age);
- 4) peak of HBER-RSV lasting 3 weeks (peak 3 weeks);
- 5) 1 month of maternal immunity and 6 months of immunity following infection (short immunity);
- 6) 4 months of maternal immunity and 12 months of immunity following infection (long immunity);
- 7) 50% reduction of contacts in the 0-2 months age group.

All analyses were conducted using R software (version 4.3.2). The *odin* package was used to run the RSV dynamical models.

Role of the funding source

The funding source of the study had no role in study design, data collection, data analysis, data interpretation, or writing of the report.

Results

The annual number of hospitalisations for bronchiolitis following emergency room visits (HBER) in children <24 months of age ranged from 37,700 (2017-2018) to 39,000 (2018-2019) in the pre-COVID period. Following SARS-CoV-2 emergence, it decreased to 30,100 (2019-2020), 23,300 (2020-2021), 36,700 (2021-2022) before increasing to 44,700 HBER in 2022-2023. For the ongoing 2023-2024 season, 26,200 HBER were recorded as of January 31, 2024 (Figure 1).

The behaviour of our reconstructed indicator for hospitalisations for RSV bronchiolitis following emergency room visits (HBER-RSV) aligns with our expectations and synthesises data from both the hospital and virologic surveillance networks (Figure 1). During epidemic periods, the majority of HBER are attributed to RSV, whereas outside of these periods HBER are generally not related to RSV. Based on this indicator, we estimate that in the pre-COVID-19 era, there were between 25,200 and 29,400 HBER-RSV annually; around 14,200 to 25,300 during the COVID-19 period (between mid-2019 and mid-2022); and then 32,600 in 2022-2023. There have been 19,500 HBER-RSV in the first part of the 2023-2024 season (up to February 4, 2024), (Figure 1).

The model was able to accurately reproduce the dynamics of HBER-RSV across different age groups (Figure 3) as well as age-specific seroprevalence data (Figure S5 and Figure S6 appendix p. 11). It captured the important disruptions associated with the implementation of non-pharmaceutical interventions (NPIs) during the COVID-19 pandemic, leading to a delayed peak and a reduction in HBER-RSV during the 2020-2021 season, and a rebound in 2022-2023. Estimates of the reduction of RSV transmission rates due to COVID-19 NPIs are

provided in appendix (Figure S7A appendix p. 12). . We also estimated a slight rise in transmission rates during the 2022-2023 and 2023-2024 seasons. The probability of HBER-RSV upon RSV infection was estimated to rapidly decrease with age from 14% in 0-2 months to 0.5% in 12-23 months age groups (Figure S7B appendix p. 12). The model estimated that, in the pre-COVID-19 period, seasonal incidence was 60% in infants aged 0-5 months, and 54% in individuals aged ≥ 36 months, with important reductions during COVID-19 NPIs and a rebound in 2022-2023 (Figure S7C appendix p. 12).

In the age groups to which nirsevimab was not administered (>5 months age group), the peak of HBER-RSV was of the same magnitude in 2023-2024 as in 2022-2023 (Figure 3). However, for children aged 0-2 months, the peak of HBER-RSV was 47% lower in 2023-2024 (with nirsevimab administration) than in 2022-2023 (without nirsevimab administration). These age group differences suggest an important impact of nirsevimab on HBER-RSV in the target group in 2023-2024.

These observations were confirmed by the mathematical model (Figure 3), which predicted that the number of HBER-RSV observed in the 0-2 months age group was 35% (25%-44%) lower than what would have been expected without nirsevimab administration. This corresponds to a 23% (16%-30%) reduction in the total number of HBER-RSV due to nirsevimab administration.

The model estimated that, in France (excluding overseas territories), nirsevimab administration averted 5,800 (3,700-7,800) HBER-RSV (Table 1), including 4,200 (2,900-5,600) among infants aged 0-2 months as well as noticeable reductions in the 3-5 months age group (Figure S8 in appendix p. 13), between September 15 and February 4, 2024. In our baseline scenario with $n=215,000$ doses administered by January 31, 2024, the effectiveness of nirsevimab against HBER-RSV was estimated at 73% (61%-84%), corresponding to one HBER-RSV case prevented for every 39 (26-54) doses administered.

In the sensitivity analysis, the number of HBER-RSV averted varied slightly with assumptions about the duration of immunity (short: 6,000, 4,000-8,000; long: 5,400, 3,200-7,600), the magnitude of HBER-RSV peak (100% of the HBER peak: 6,300, 4,200-8,700; 80%: 5,100, 3,200-6,800), and the duration of the peak (3 weeks: 5,500, 3,600-7,700).

Nirsevimab effectiveness varied slightly with assumptions about the number of doses administered (205,000 doses: 76%, 64%-89%; 220,000 doses: 71%, 58%-82%), the duration of immunity (short: 74%, 62%-85%; long: 70%, 57%-83%), infant contact rates (50% reduction in contacts in the 0-2 months age group: 76%, 61%-89%), and the duration of the peak (3 weeks: 68%; 57%-80%).

The number of doses administered to avert one HBER-RSV case was minimum (36; 24-51) and maximum (43; 29-62) when the HBER-RSV peak was assumed to be 100% and 80% of the HBER peak, respectively.

The probability of HBER-RSV upon infection increased when duration of immunity increased and when 50% reduction of contact in the 0-2 months age group was assumed (Figure S9 in appendix p. 13).

Discussion

In this study, we capitalised on France's early administration of nirsevimab, along with strong population adherence, to evaluate its real-world population-level impact and effectiveness in reducing HBER-RSV. Our findings reveal an important reduction in HBER-RSV in France in 2023-2024, among infants aged 0-2 months who were mostly targeted by the nirsevimab campaign. With one HBER-RSV averted for about every 40 children who received nirsevimab, our study highlights the relevance of the treatment to reduce RSV-related hospitalisations.

A previous study²² in Luxembourg highlighted the impact of nirsevimab at the beginning of the 2023-2024 season, with a 38% decrease in RSV-related hospitalisations compared to the previous season. This reduction was particularly notable among infants under 6 months of age, where a 69% decrease was recorded. Another study²³ in Galicia (Spain) showed a reduction of 90% of RSV-related LRTI hospitalisations in 2023-2024 compared to historical seasons. However, given the important disruptions of RSV epidemic patterns during and post COVID-19 NPIs, inter-seasonal variations might be caused by multiple factors. To address this challenge, we developed a mathematical model that we used to construct counterfactual scenarios simulating what would have happened in the absence of nirsevimab administration.

In clinical trials, efficacy against hospitalisation for RSV LRTI was estimated between 77% (49%-89%) and 83% (68%-92%).^{8,9} In real-world studies,²³⁻²⁶ effectiveness of nirsevimab against RSV-related hospitalisations was estimated between 70% and 90%, in line with our point estimate of effectiveness of 73% against HBER-RSV. The variability observed among the different studies could stem from several factors, including differences in outcome of interest, study design, study duration with a waning of nirsevimab effectiveness, demographics, and sample sizes.

COVID-19 NPIs disrupted RSV epidemiology. This must be accounted for to achieve unbiased estimation of the impact of nirsevimab. This is why we dedicated a lot of effort modelling the impact of the different NPIs and RSV immunity, ensuring that we correctly captured HBER-RSV dynamics, overall and by age group (Figure 3). Three lockdowns were implemented in France in March-May 2020, November 2020 and April 2021, with schools closed only in the first one. The first lockdown occurred out of the RSV epidemic season. We hypothesise that open schools during the last two lockdowns explain why reductions in transmission rates during these lockdowns were limited to 29%. Our estimated reductions in transmission rates for the different NPIs translate in an overall reduction in the cumulative number of RSV-related bronchiolitis of 71% between April 1, 2020 and March 31, 2021

compared to the same period during season 2018-2019, which is consistent with the literature.²⁷ Our baseline scenario with an average duration of immunity following infection of 9 months had higher likelihood than those with durations of 6 and 12 months (Figure S10 in appendix p. 14) suggesting that post-COVID RSV dynamics might inform on RSV immunity. In the model, the large peaks of HBER-RSV observed in 2022-2023 and 2023-2024 were explained by the depletion of susceptibles during the COVID-19 pandemic (Figure S11 in appendix p. 14) as well as slight increases (5-8%) in transmission rates in post-COVID seasons.

In our study, we estimated a seasonal incidence of 54% for RSV in ≥ 3 years age group. These results are compatible with a longitudinal household study conducted in South Africa reporting attack rates of 49% in the 5-12 year age group and 30% among those aged 19-44 years, the majority of whom were asymptomatic.²⁸ Conducting similar studies in France would help quantifying infants risk of contracting RSV according to household composition, and thus designing effective preventive measures.

It is important to note that HBER-RSV are a subset of hospitalisations for RSV bronchiolitis, which form part of the wider spectrum of RSV-related hospitalisations. As a result, the total number of RSV-related hospitalisations averted due to nirsevimab is greater than the number of HBER-RSV averted that we estimated here. The estimated number of hospitalisations averted depends on how the nirsevimab campaign was performed in France and cannot be applied to other countries.

Our work has a number of limitations. Although there was no age-specific data on nirsevimab administration, we used data on doses delivered to maternity wards and community pharmacies to develop credible administration scenarios. However, uncertainty remains. We might underestimate nirsevimab effectiveness if we assumed that too many children received the treatment; however, our estimates are consistent with those in the literature. French age-specific data on RSV-related hospitalisations are lacking. As a

consequence, we constructed an indicator to capture age-stratified HBER-RSV dynamics, derived from hospital surveillance for bronchiolitis hospitalisations and hospital laboratory surveillance for confirmed RSV cases. Given uncertainty about our indicator, we explored sensitivity of our results to assumptions about the proportion of RSV bronchiolitis hospitalisations during peak periods. Establishing a comprehensive virological surveillance network in French hospitals, incorporating key covariates such as age, would be instrumental to obtain more accurate and reliable data for future research. The French Medicalisation of Information Systems Programme dataset contains age-stratified RSV-bronchiolitis hospitalisation data. We did not use it here because of delays in data availability but it may be a valuable source of information for future retrospective assessments. The cross-sectional serological study has a small sample size. In addition, the sample is representative of patients attending hospital in France, which may differ from the general population. We note however that our seroprevalence estimates are consistent with those from a Dutch study.²⁹ Furthermore, in the absence of seroprevalence estimates in <1 year old infants, our model reconstructed levels of circulation in this group by jointly analysing all available data, in particular seroprevalence in other age groups and contact data between age groups. We also explored how our results would be modified if <1 year old children were less exposed to RSV than assumed in our baseline scenario. Access to representative samples, in particular in <1 year old infants, would enhance our understanding of transmission. In the model, individuals move between age groups with a constant ageing rate. As a result, the age distribution of treated individuals may not perfectly match what might be expected when following up birth cohorts. However, we expect the phenomenon to be relatively limited given the short time period we consider here. We did not account for the use of palivizumab, a monoclonal antibody recommended for infants at high-risk for RSV. During the 2023-2024 season, it is conceivable that a subset of these high-risk infants might have received nirsevimab as an alternative to palivizumab. Such substitution could lead to underestimating nirsevimab effectiveness in our analysis. Finally, we assumed that nirsevimab reduced severity upon infection, not the susceptibility to

infection. To our knowledge, the efficacy of nirsevimab against susceptibility is largely unknown. Nonetheless, given that the majority of contacts of individuals <12 months come from contacts with those ≥ 36 months, a reduction in susceptibility after treatment should not dramatically modify RSV dynamics and the number of HBER-RSV averted.

Compared to the use of palivizumab that has been limited to specific risk groups for severe RSV disease, our study shows the benefits of a broader delivery of nirsevimab to newborns in terms of hospitalisations averted. Other control strategies are becoming available such as maternal vaccination and vaccination for the elderly. Our modelling framework could be expanded to prospectively investigate how these strategies could be optimised; and to retrospectively quantify their impact when implemented in future epidemics.

Data sharing

The code and data are available at <https://gitlab.pasteur.fr/mmmi-pasteur/rsv-nirse>.

Contributors

AB, SV and SC conceived the study. AB developed the code. JP, IPC, JSC, SV, and SC supervised the project. IP, VE, CD, MARW, BL collected data. EB, GB and MW generated and analysed serological data. AB and SC wrote the initial draft of the manuscript; had access and verified the existence of the model code and the data used as input for the model; had final responsibility for the decision to submit the manuscript for publication. All authors reviewed and approved the final manuscript.

Declaration of interests

The authors declare no competing interests.

Acknowledgments

This project is supported by the European Commission under the EU4Health programme 2021-2027, Grant Agreement - Project: 101102733 — DURABLE, the Laboratoire

d'Excellence Integrative Biology of Emerging Infectious Diseases program (grant ANR-10-LABX-62-IBEID) and the INCEPTION project (PIA/ANR16-CONV-0005). Authors thank all emergency rooms for their participation in the OSCOUR® network and hospital laboratories participating in the RENAL network. AB expresses his gratitude to Paolo Bosetti and Noé Ochida for their insightful discussions.

References

- 1 Li Y, Wang X, Blau DM, *et al.* Global, regional, and national disease burden estimates of acute lower respiratory infections due to respiratory syncytial virus in children younger than 5 years in 2019: a systematic analysis. *Lancet* 2022; **399**: 2047–64.
- 2 Reeves RM, Hardelid P, Gilbert R, Warburton F, Ellis J, Pebody RG. Estimating the burden of respiratory syncytial virus (RSV) on respiratory hospital admissions in children less than five years of age in England, 2007-2012. *Influenza Other Respi Viruses* 2017; **11**: 122–9.
- 3 Del Riccio M, Spreuwenberg P, Osei-Yeboah R, *et al.* Burden of Respiratory Syncytial Virus in the European Union: estimation of RSV-associated hospitalizations in children under 5 years. *J Infect Dis* 2023; **228**: 1528–38.
- 4 Freymuth F, Vabret A, Dina J, *et al.* [Bronchiolitis viruses]. *Arch Pediatr* 2010; **17**: 1192–201.
- 5 García CG, Bhore R, Soriano-Fallas A, *et al.* Risk factors in children hospitalized with RSV bronchiolitis versus non-RSV bronchiolitis. *Pediatrics* 2010; **126**: e1453–60.
- 6 Vaux S, Viriot D, Forgeot C, *et al.* Bronchiolitis epidemics in France during the SARS-CoV-2 pandemic: The 2020-2021 and 2021-2022 seasons. *Infect Dis Now* 2022; **52**: 374–8.
- 7 SPF. Bulletin épidémiologique bronchiolite. Bilan de la surveillance 2022-2023. <https://www.santepubliquefrance.fr/maladies-et-traumatismes/maladies-et-infections-respiratoires/bronchiolite/documents/bulletin-national/bulletin-epidemiologique-bronchiolite.-bilan-de-la-surveillance-2022-2023> (accessed Feb 22, 2024).
- 8 Drysdale SB, Cathie K, Flamein F, *et al.* Nirsevimab for Prevention of Hospitalizations Due to RSV in Infants. *N Engl J Med* 2023; **389**: 2425–35.
- 9 Muller WJ, Madhi SA, Seoane Nuñez B, *et al.* Nirsevimab for Prevention of RSV in Term and Late-Preterm Infants. *N Engl J Med* 2023; **388**: 1533–4.
- 10 De Luca D, Sanchez-Luna M, Schettler K, Bont L, Baraldi E. Universal infant immunisation against respiratory syncytial virus and European inequalities: the pandemics lesson has not been learnt. *Lancet Reg Health Eur* 2023; **34**: 100753.
- 11 Ministère du travail, de la santé et des solidarités. Direction générale de la Santé. DGS-Urgent n° 2023-19, 26 septembre 2023. Beyfortus (Nirsevimab) : priorisation temporaire des patients à immuniser [Beyfortus (Nirsevimab): temporary prioritisation of patients to be immunised].

https://sante.gouv.fr/IMG/pdf/dgs-urgent_-19_mise_a_disposition_beyfortus.pdf
(accessed Feb 27, 2024).

- 12 Réseau OSCOUR®.
<https://www.santepubliquefrance.fr/surveillance-syndromique-sursaud-R/reseau-oscour-R>
(accessed Jan 18, 2024).
- 13 Bhatia R. Bronchiolitis. MSD Manual Professional Edition.
<https://www.msmanuals.com/professional/pediatrics/respiratory-disorders-in-young-children/bronchiolitis> (accessed Feb 28, 2024).
- 14 Polack FP, Stein RT, Custovic A. The Syndrome We Agreed to Call Bronchiolitis. *J Infect Dis* 2019; **220**: 184–6.
- 15 Petat H, Gajdos V, Angoulvant F, *et al.* High Frequency of Viral Co-Detections in Acute Bronchiolitis. *Viruses* 2021; **13**. DOI:10.3390/v13060990.
- 16 Woudenberg T, Pelleau S, Anna F, *et al.* Humoral immunity to SARS-CoV-2 and seasonal coronaviruses in children and adults in north-eastern France. *EBioMedicine* 2021; **70**: 103495.
- 17 Hodgson D, Pebody R, Panovska-Griffiths J, Baguelin M, Atkins KE. Evaluating the next generation of RSV intervention strategies: a mathematical modelling study and cost-effectiveness analysis. *BMC Med* 2020; **18**: 348.
- 18 Koltai M, Krauer F, Hodgson D, *et al.* Determinants of RSV epidemiology following suppression through pandemic contact restrictions. *Epidemics* 2022; **40**: 100614.
- 19 Pitzer VE, Viboud C, Alonso WJ, *et al.* Environmental drivers of the spatiotemporal dynamics of respiratory syncytial virus in the United States. *PLoS Pathog* 2015; **11**: e1004591.
- 20 Mistry D, Litvinova M, Pastore Y Piontti A, *et al.* Inferring high-resolution human mixing patterns for disease modeling. *Nat Commun* 2021; **12**: 323.
- 21 Henderson FW, Collier AM, Clyde WA Jr, Denny FW. Respiratory-syncytial-virus infections, reinfections and immunity. A prospective, longitudinal study in young children. *N Engl J Med* 1979; **300**: 530–4.
- 22 Ernst C, Bejko D, Gaasch L, *et al.* Impact of nirsevimab prophylaxis on paediatric respiratory syncytial virus (RSV)-related hospitalisations during the initial 2023/24 season in Luxembourg. *Euro Surveill* 2024; **29**. DOI:10.2807/1560-7917.ES.2024.29.4.2400033.
- 23 Effectiveness and impact of universal prophylaxis with nirsevimab in infants against hospitalisation for respiratory syncytial virus in Galicia, Spain: initial results of a population-based longitudinal study. *Lancet Infect Dis* 2024; published online April 30. DOI:10.1016/S1473-3099(24)00215-9.
- 24 López-Lacort M, Muñoz-Quiles C, Mira-Iglesias A, *et al.* Early estimates of nirsevimab immunoprophylaxis effectiveness against hospital admission for respiratory syncytial virus lower respiratory tract infections in infants, Spain, October 2023 to January 2024. *Euro Surveill* 2024; **29**. DOI:10.2807/1560-7917.ES.2024.29.6.2400046.
- 25 Moline HL, Tannis A, Toepfer AP, *et al.* Early Estimate of Nirsevimab Effectiveness for Prevention of Respiratory Syncytial Virus-Associated Hospitalization Among Infants

Entering Their First Respiratory Syncytial Virus Season - New Vaccine Surveillance Network, October 2023-February 2024. *MMWR Morb Mortal Wkly Rep* 2024; **73**: 209–14.

- 26 Ezpeleta G, Navascués A, Viguria N, *et al.* Effectiveness of Nirsevimab Immunoprophylaxis Administered at Birth to Prevent Infant Hospitalisation for Respiratory Syncytial Virus Infection: A Population-Based Cohort Study. *Vaccines (Basel)* 2024; **12**. DOI:10.3390/vaccines12040383.
- 27 Lenglar L, Ouldali N, Honeyford K, *et al.* Respective roles of non-pharmaceutical interventions in bronchiolitis outbreaks: an interrupted time-series analysis based on a multinational surveillance system. *Eur Respir J* 2023; **61**. DOI:10.1183/13993003.01172-2022.
- 28 Cohen C, Kleynhans J, Moyes J, *et al.* Incidence and transmission of respiratory syncytial virus in urban and rural South Africa, 2017-2018. *Nat Commun* 2024; **15**: 116.
- 29 Andeweg SP, Schepp RM, van de Kasstele J, Mollema L, Berbers GAM, van Boven M. Population-based serology reveals risk factors for RSV infection in children younger than 5 years. *Sci Rep* 2021; **11**: 8953.

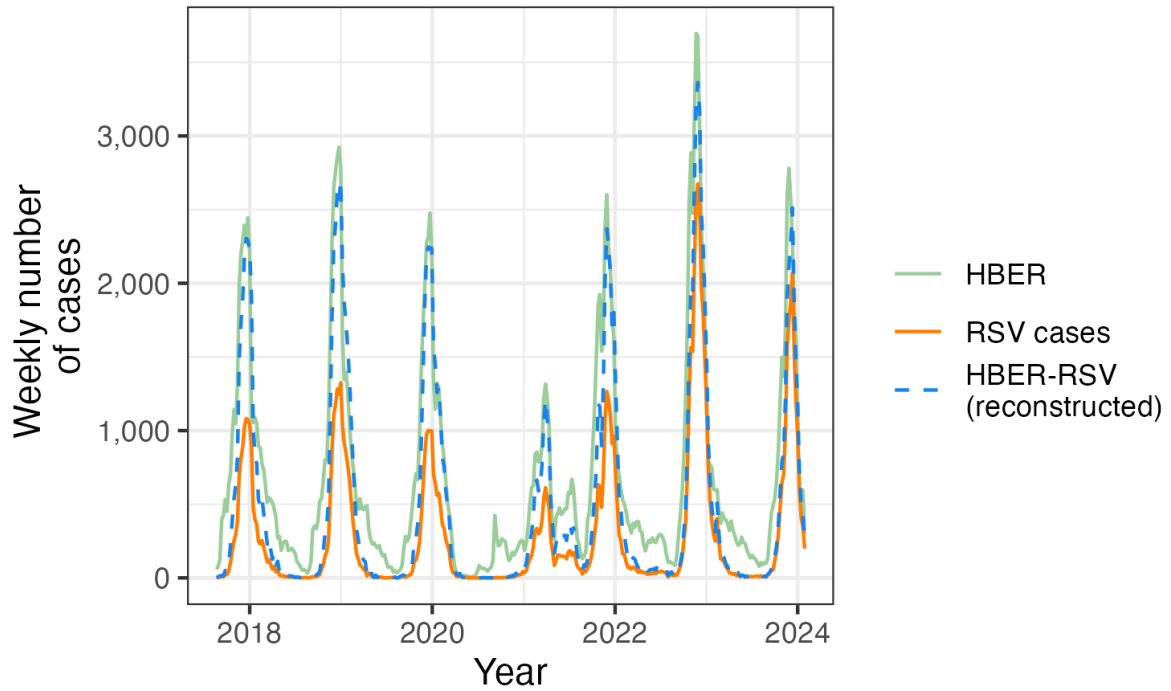

Figure 1: Hospital syndromic and virological surveillance. Number of hospitalisations for bronchiolitis following emergency room visits (HBER; OSCOUR® data - green), number of RSV positive tests in the RENAL hospital laboratory network (RSV cases in RENAL - orange), and reconstructed number of hospitalisations for RSV bronchiolitis following emergency room visits (HBER-RSV - dashed blue).

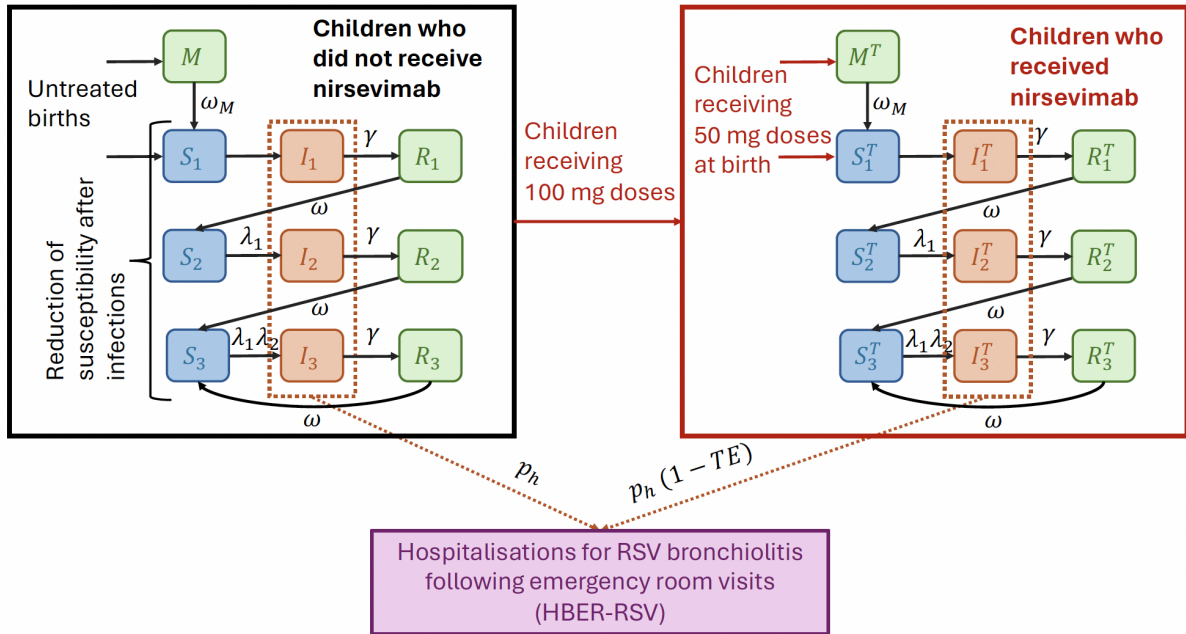

Figure 2: Flow diagram of the RSV transmission model (without age-structure).

Simplified representation of the compartmental RSV transmission model with nirsevimab administration, without age-structure. The green compartments represent individuals immunised against infection, the blue compartments individuals susceptible to infection, and the orange compartments infected/infectious individuals. Individuals in S_3 are less susceptible to infection than in S_2 , which are less susceptible than in S_1 . Children who receive nirsevimab are given either a 50 mg dose at birth (arrows entering the M^T and S_1^T compartments) or a 100 mg dose between the ages of 0-5 years (middle arrow between the compartments for treated and untreated children). Some children do not receive the treatment at all, while others go through a period without nirsevimab before eventually receiving it, and a third group receives the treatment at birth. The probability of HBER-RSV upon infection p_h is multiplied by $1 - TE$ for children who received nirsevimab, with TE is the nirsevimab effectiveness. The age-structure of the model is not represented in the figure (see Figure S2 in appendix p. 4 for a complete flow diagram).

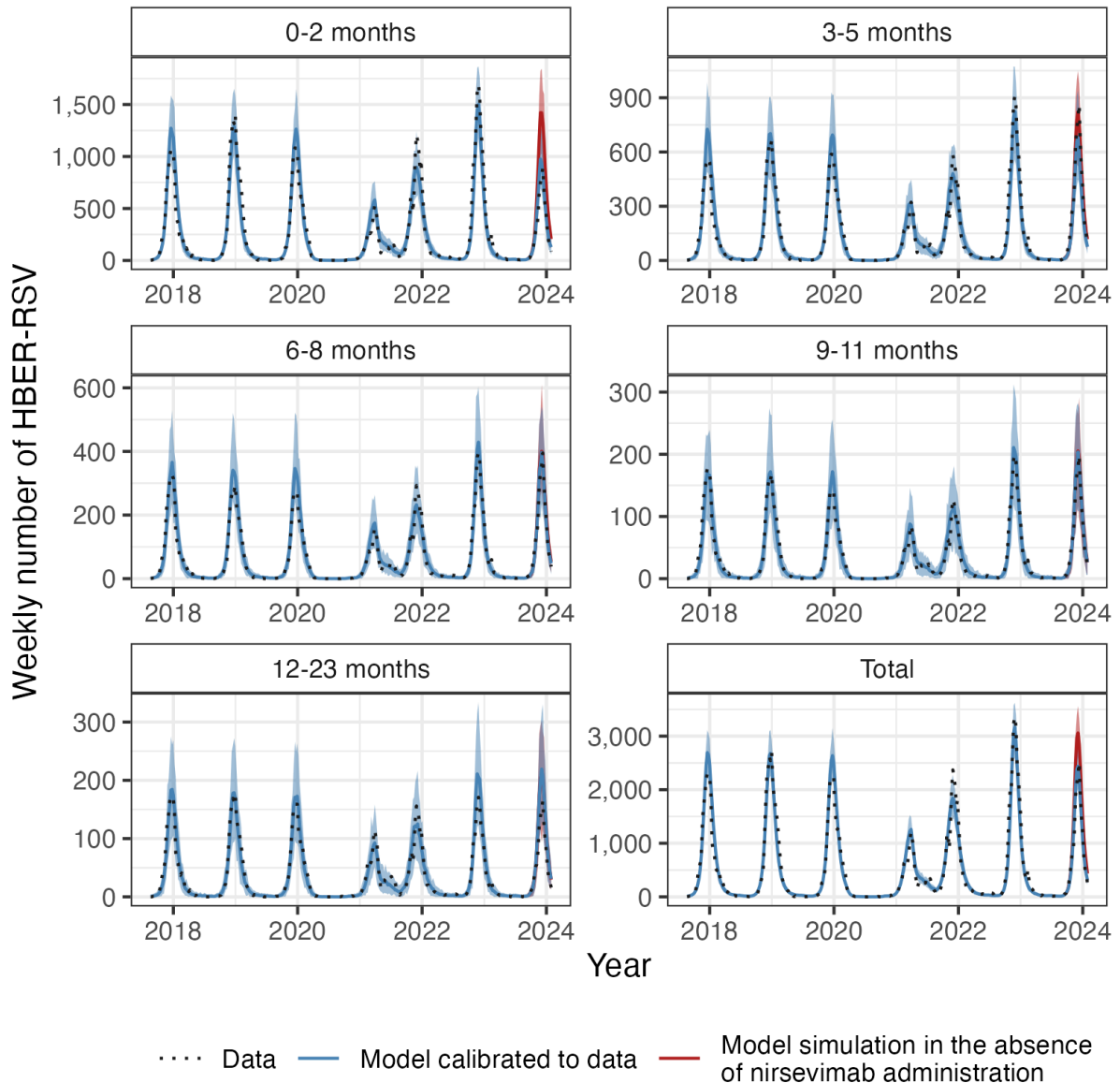

Figure 3: Model calibration to data. Observed (black dots) and predicted (blue curves) dynamics of hospitalisations for RSV bronchiolitis following emergency room visits (HBER-RSV) in different age groups, assuming that 215,000 doses of nirsevimab were administered by 31 January 2024. The red curves correspond to model simulations in the absence of nirsevimab administration. The solid lines represent the medians predicted by the model and the transparent areas represent the 95% quantile intervals predicted by the model. The comparison between the reconstruction of the RSV serology in the model and the data is available in appendix p. 11, Figure S5.

Scenario	Nirsevimab effectiveness against HBER-RSV	Number of HBER-RSV averted	Number of doses administered to avert one HBER-RSV
baseline	73% (61%-84%)	5800 (3700-7800)	39 (26-54)
205,000 doses	76% (64%-89%)	5800 (3800-7900)	37 (26-53)
220,000 doses	71% (58%-82%)	5700 (3800-7700)	40 (27-55)
peak 80%	73% (59%-85%)	5100 (3200-6800)	43 (29-62)
peak 100%	73% (60%-85%)	6300 (4200-8700)	36 (24-51)
peak age	73% (61%-85%)	5800 (4000-7800)	38 (27-53)
peak 3 weeks	68% (57%-80%)	5500 (3600-7700)	41 (27-59)
short immunity	74% (62%-85%)	6000 (4000-8000)	37 (26-52)
long immunity	70% (57%-83%)	5400 (3200-7600)	42 (25-61)
50% contact reduction in the 0-2 months age group	76% (61%-89%)	5900 (3400-8100)	39 (24-56)

Table 1: Nirsevimab effectiveness and HBER-RSV averted for different scenarios.

Nirsevimab effectiveness against hospitalisations for RSV bronchiolitis following emergency room visits (HBER-RSV), number of HBER-RSV averted, and number of doses administered to avert one HBER-RSV with respect to the scenarios considered in the sensitivity analysis. The different scenarios are: 205,000 or 220,000 doses administered by January 31, 2024 (205,000 doses; 220,000 doses); peak of HBER-RSV equal to 80% or 100% of the HBER peak (peak 80%; peak 100%); peak of HBER-RSV equal to 90% of the HBER peak in 0-2 months and 3-5 months age groups and 80% in older age groups (peak age); peak of HBER-RSV lasting 3 weeks (peak 3 weeks); 1 month of maternal immunity and 6 months of immunity following infection (short immunity); 4 months of maternal immunity and 12 months of immunity following infection (long immunity); 50% reduction of contacts in the 0-2 months age group. Ranges in parenthesis are the 95% credible intervals.

Supplementary Materials

Estimates of effectiveness and impact of nirsevimab on hospitalisations for RSV bronchiolitis in France, 2023-2024 : a modeling study

Antoine Brault, Isabelle Pontais, Vincent Enouf, Christine Debeuret, Emma Bloch, Juliette Paireau, Marie Anne Rameix-Welti, Michael White, Gaëlle Baudemont, Bruno Lina, Isabelle Parent du Châtelet, Jean-Sébastien Casalegno, Sophie Vaux, Simon Cauchemez

Table of contents

1. Reconstruction of the number of hospitalisations for RSV bronchiolitis following emergency room visits.....	2
2. Proportion of emergency room visits in OSCOUR network.....	3
3. Serological data.....	3
4. Nirsevimab doses administered.....	4
5. Model flow chart.....	4
6. Ordinary differential equations of the transmission model.....	4
7. Demographic dynamic.....	7
8. Contact matrix.....	7
9. Description of transmission model parameters.....	8
10. Likelihood and Markov chain Monte Carlo calibration.....	10
11. RSV seropositivity inferred by the model.....	11
12. Model estimates.....	12
13. Sensitivity analysis.....	13

1. Reconstruction of the number of hospitalisations for RSV bronchiolitis following emergency room visits

A season period is defined as spanning from week 34 of one year to week 33 of the following year. Let $HBER(t, a)$ the number of hospitalisations for bronchiolitis following emergency room visits (HBER) in week t , in age group a (observed), $HBER_{RSV}(t, a)$ the number of hospitalisations for RSV bronchiolitis following emergency room visits in week t , in age group a (unobserved), $RSV_{renal}(t)$ the number of RSV positive hospital cases in the RENAL network in week t (observed), $RSV_{renal,B}(t)$ the number of bronchiolitis tested positive to RSV in the RENAL network in week t (unobserved), and $B_{renal}(t)$ the number of patients with bronchiolitis tested for RSV in the RENAL network in week t (unobserved). OSCOUR and RENAL data provided $HBER(t, a)$ and $RSV_{renal}(t)$ values, respectively; the other quantities cannot be directly measured from the available data.

We make the following assumptions to estimate $HBER_{RSV}(t, a)$:

1. The proportion of individuals infected by RSV among HBER is equal to the proportion of individuals testing positive to RSV among patients hospitalised with bronchiolitis tested for RSV in the RENAL network:

$$\frac{HBER_{RSV}(t,a)}{HBER(t,a)} = \frac{RSV_{renal,B}(t)}{B_{renal}(t)}.$$

2. During each season, $HBER(t, a)$ is proportional to the number of patients hospitalised with bronchiolitis tested for RSV in the RENAL network, i.e. for t a week in season s :

$$HBER(t, a) = \rho_1(s, a) \cdot B_{renal}(t),$$

where $\rho_1(s, a)$ is a factor depending only on the season s and age group a .

3. In RENAL network, the proportion of patients with bronchiolitis who test positive for RSV among patients tested positive for RSV is constant:

$$\frac{RSV_{renal,B}(t)}{RSV_{renal}(t)} = \rho_2 \text{ where } \rho_2 \text{ is a constant.}$$

4. For each season and in each age group, the peak of HBER-RSV cases corresponds to $p=90\%$ of the peak of HBER cases.

We decompose:

$$\frac{RSV_{renal,B}(t)}{B_{renal}(t)} = \frac{RSV_{renal}(t)}{B_{renal}(t)} \cdot \frac{RSV_{renal,B}(t)}{RSV_{renal}(t)}.$$

Then according to hypothesis 1,

$$\frac{HBER_{RSV}(t,a)}{HBER(t,a)} = \frac{RSV_{renal,B}(t)}{B_{renal}(t)} = \frac{RSV_{renal}(t)}{B_{renal}(t)} \cdot \frac{RSV_{renal,B}(t)}{RSV_{renal}(t)}.$$

It follows from hypothesis 2 that

$$\frac{HBER_{RSV}(t,a)}{HBER(t,a)} = \frac{RSV_{renal}(t)}{HBER(t,a)} \cdot \rho_1(s, a) \cdot \frac{RSV_{renal,B}(t)}{RSV_{renal}(t)},$$

and from hypothesis 3 that

$$\frac{HBER_{RSV}(t,a)}{HBER(t,a)} = \frac{RSV_{renal}(t)}{HBER(t,a)} \cdot \rho_1(s, a) \cdot \rho_2.$$

We then obtain that

$$HBER_{RSV}(t, a) = \rho(s, a) \cdot RSV_{renal}(t),$$

where $\rho(s, a) = \rho_1(s, a) \cdot \rho_2$. According to hypothesis 4, during each season s and each week t in the season s ,

$$\max_{u \text{ weeks in } s} (HBER_{RSV}(u, a)) / \max_{u \text{ weeks in } s} (HBER(u, a)) = p = 0.9.$$

We deduce that for each season s , each week t in season s :

$$HBER_{RSV}(t, a) = p \cdot \frac{\max_{u \text{ weeks in season } s} (HBER(u, a))}{\max_{u \text{ weeks in season } s} (RSV_{renal}(u))} \cdot RSV_{renal}(t).$$

This last formula allows us to reconstruct the number of hospitalisations for RSV bronchiolitis following emergency room visits. The amplitude of the HBER-RSV peak depends solely on HBER, which has not been affected by the increase in RSV testing occurring in RENAL following the COVID-19 pandemic.

2. Proportion of emergency room visits in OSCOUR network

Year	Proportion of emergency room visits in OSCOUR	Proportion of emergency room visits coded with a diagnostic
2017	92.3%	76.6%
2018	94.4%	76.5%
2019	94.3%	77.4%
2020	93.9%	79.4%
2021	95.5%	83.1%
2022	96.6%	87.2%
2023	96.6% (assumed)	87.8%
2024	96.6% (assumed)	87.8% (assumed)

Table S1: Proportion of emergency room visits registered in OSCOUR. The first column is the year, the second column represents the proportion of emergency room visits in French territory registered in the OSCOUR network, and the third column is the proportion of emergency room visits coded with a diagnostic. For 2023 and 2024, some of these statistics were not available, so we assumed they were similar to the previous year and indicated in the table that this was an assumption with the term assumed in brackets.

3. Serological data

Between February and August 2020, the SeroPed study, a cross-sectional serological survey, was carried out among 2,499 patients admitted to French hospitals for reasons other than COVID-19 with extensive sampling among children under 10 years of age (804 of 2,499).¹ Leftover samples from routine diagnostic procedures were used for serological testing of coronaviruses. In the context of our study, we obtained authorisation to test 1,132 samples for RSV serology testing, with 275 from children under 10 years of age. IgG antibody levels to an RSV A lysate were measured using a bead-based multiplex serological assay. Samples were run at a final dilution of 1:200. Plates were read using the Intelliflex® technology from Luminex®, and the median fluorescence intensity was used for analysis. Participants were classified as seropositive for RSV based on measurements of IgG antibodies against viral lysates specific to the RSV-A subtype (purchased from The Native Antigen Company, UK). The threshold for seropositivity was established for paediatric patients by subtracting two standard deviations from the average antibody titers observed in the adult cohort. In each age group (12-23 months, 24-35 months and more than 36 months), we calculated the seroprevalence by dividing the number of seropositive individuals in each age group by the number of individuals within that specific age group.

Age	RSV seropositive samples	Samples	RSV seropositivity
12-23 months	25	29	86% (68%-96%)
24-35 months	20	20	100% (83%-100%)
More than 36 months	1061	1064	100% (99%-100%)

Table S2: Serological data. The table presents the results by age group of the SeroPed cross-sectional study conducted between February and August 2020 in French hospitals. In the column RSV seropositivity, the 95% confidence intervals are given in parentheses.

4. Nirsevimab doses administered

In January 2024, reports from a subset of 160 maternity wards indicated that their remaining stocks constituted only 4% of the 50 mg doses but 63% of the 100mg doses reflecting the typical weight of neonates in these settings. In community pharmacies data on their remaining stock were not available for 2024. Given the high uptake of the medication, we assumed that i) 6% of the doses allocated to pharmacies remained unused and that ii) stock levels were similar in maternity wards that did and did not report their stocks in January 2024.

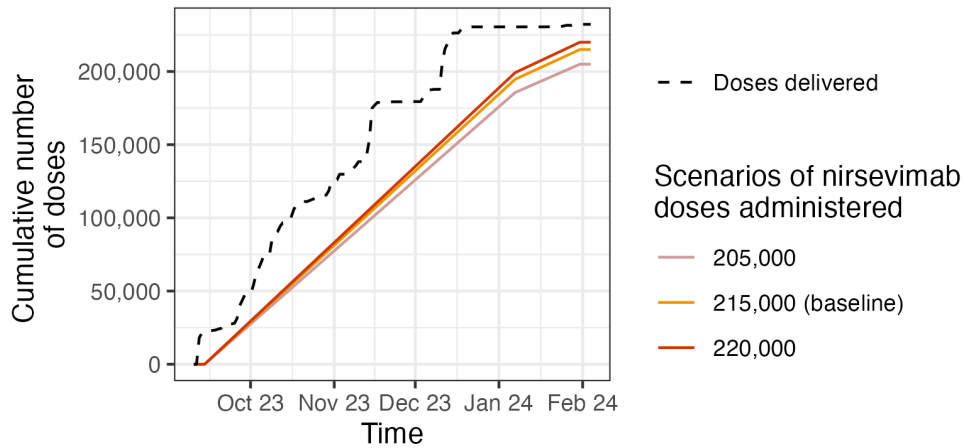

Figure S1: Nirsevimab doses administered. Cumulative number of nirsevimab doses delivered to maternity wards and community pharmacy (dashed black) and scenarios for the cumulative number of nirsevimab doses administered by January 31, 2024: 205,000 (pink), 215,000 (orange) and 220,000 (red) doses.

5. Model flow chart

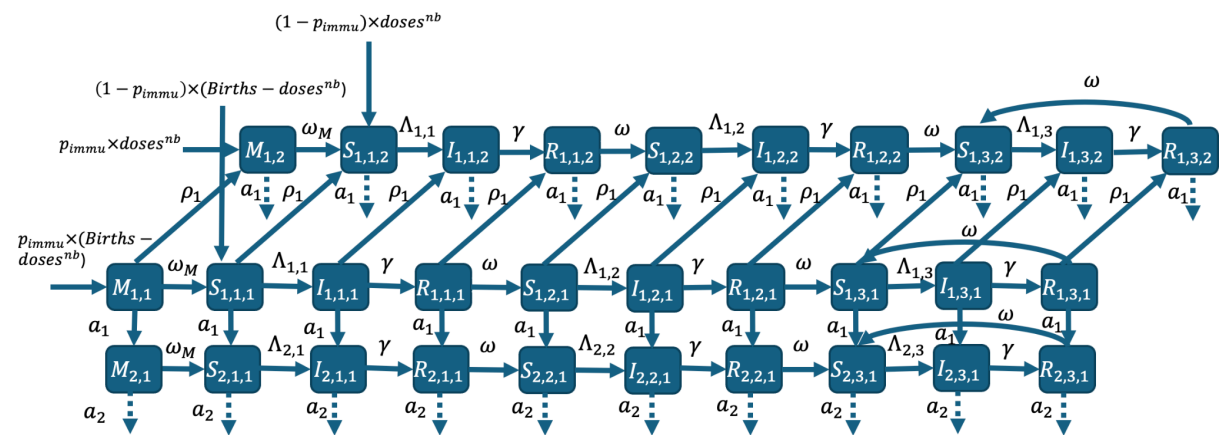

Figure S2: Model flow chart.

6. Ordinary differential equations of the transmission model

We refer to:

- age groups 0-2 months, 3-5 months, 6-8 months, 9-11 months, 1 year, 2 years, ≥ 3 years using indices 1 to 7,
- the levels of exposure with indices 1 to 3 with indice 1 stands for no previous infection, indice 2 stands for 1 previous infection, and indice 3 at least 2 previous infections,
- treatment status with indice 1 for individuals not treated, and indice 2 for individuals treated with nirsevimab.

The population is split in the following compartments:

- $M_{i,k}$: number of individuals in age group i and treatment group k protected from infection by maternal immunity;
- $S_{i,j,k}$: number of susceptible individuals in age group i , exposed group j and treatment group k ;
- $I_{i,j,k}$: number of infectious individuals in age group i , exposed group j and treatment group k ;
- $R_{i,j,k}$: number of immunised individuals in age group i , exposed group j and treatment group k .

The seasonal variation of the transmission rate is defined as:

$$\beta_{seas}(t) = \mu(t) \left(\beta_{min} + (\beta_{max} - \beta_{min}) 0.5 \left(1 + \cos \left(\frac{t - t_{peak}}{2\pi} \right) \right) \right),$$

Where $\mu(t)$ is equal to a parameter of reduction of transmission μ_{school} between July 1 and August 31 of each year, otherwise $\mu(t)$ is equal to 1; β_{min} and β_{max} are the minimum and maximum of the transmission rate ; t_{peak} is the timing in the peak of transmissibility.

We denote respectively λ_1 the reduction of susceptibility following a first infection with respect to no previous infection and λ_2 the reduction of susceptibility following two or more infections with respect to the first infection. Then the relative reduction of susceptibility with respect to no previous infection is:

$$\lambda'_j = \begin{cases} 0, & \text{for } j = 1 \\ \lambda_1, & \text{for } j = 2 \\ \lambda_1 \lambda_2, & \text{for } j = 3 \end{cases}$$

We denote c_{ij} the average number of daily contacts between an individual in age group i and individuals in age group j and $\bar{c}_{ij} := c_{ij}/c_{max}$, the contact matrix normalised by its spectral radius c_{max} (maximum absolute value of the eigenvalues of the contact matrix). The number of individuals in age group i is denoted $N_i(t)$.

The force of infection applied to individuals in $S_{i,j,k}$ is:

$$\Lambda_{i,j}(t) = \lambda'_j \eta(t) \beta_{seas}(t) \sum_{l=1}^{n_{age}} \bar{c}_{i,l} \sum_{m=1}^3 \sum_{m'=1}^2 \frac{I_{l,m,m'}(t)}{N_l(t)}, \quad (S1)$$

where $\eta(t)$ is the change in the transmission rate during summer holiday, lockdown, curfew, protective measures, 2022-2023, 2023-2024.

The model is characterised by the the following ordinary differential equations: for $i \in \{1, \dots, n_{age}\}$, $j \in \{1, 2, 3\}$, $k \in \{1, 2\}$,

$$\begin{aligned} \frac{dM_{i,k}(t)}{dt} &= \delta_{i=1,k=1} P_{immu}(t) (Births(t) - doses^{nb}(t)) + \delta_{i=1,k=2} P_{immu}(t) doses^{nb}(t) \\ &- \omega_M M_{i,k}(t) - m_i M_{i,k}(t) - \delta_{k=1} \rho_i(t) M_{i,k}(t) + \delta_{k=2} \rho_i(t) M_{i,k-1}(t) - \delta_{i < n_{age}} a_i M_{i,k}(t) \\ &+ \delta_{i > 1} a_{i-1} M_{i-1,k}(t) \end{aligned}$$

$$\begin{aligned}
\frac{dS_{i,j,k}(t)}{dt} &= -S_{i,j,k}(t) \Lambda_{i,j}(t) - m_i S_{i,j,k}(t) + \delta_{j=1} \omega_M M_{i,k}(t) \\
&+ \delta_{i=1, j=1, k=1} \left(1 - p_{immu}(t)\right) \left(Births(t) - doses^{nb}(t)\right) + \delta_{i=1, j=1, k=2} \left(1 - p_{immu}(t)\right) doses^{nb}(t) \\
&- \delta_{k=1} \rho_i(t) S_{i,j,k}(t) + \delta_{k=2} \rho_i(t) S_{i,j,k-1}(t) - \delta_{i < n_{age}} a_i S_{i,j,k}(t) \\
&+ \delta_{i > 1} a_{i-1} S_{i-1,j,k}(t) + \delta_{j \in \{2,3\}} \omega R_{i,j-1,k}(t) + \delta_{j=3} \omega R_{i,j,k}(t) \\
\frac{dI_{i,j,k}(t)}{dt} &= S_{i,j,k}(t) \Lambda_{i,j}(t) - \gamma I_{i,j,k}(t) - m_i I_{i,j,k}(t) - \delta_{k=1} \rho_i(t) I_{i,j,k}(t) \\
&+ \delta_{k=2} \rho_i(t) I_{i,j,k-1}(t) - \delta_{i < n_{age}} a_i I_{i,j,k}(t) + \delta_{i > 1} a_{i-1} I_{i-1,j,k}(t) \\
\frac{dR_{i,j,k}(t)}{dt} &= \gamma I_{i,j,k}(t) - \omega R_{i,j,k}(t) - m_i R_{i,j,k}(t) - \delta_{k=1} \rho_i(t) R_{i,j,k}(t) \\
&+ \delta_{k=2} \rho_i(t) R_{i,j,k-1}(t) - \delta_{i < n_{age}} a_i R_{i,j,k}(t) + \delta_{i > 1} a_{i-1} R_{i-1,j,k}(t)
\end{aligned}$$

where:

- $\delta_{i=v} = 1$ if and only if $i = v$, 0 otherwise
- γ is the recovery rate,
- ω is the waning rate of immunity after an infection,
- ω_M is the waning rate of maternal immunity,
- $Births(t)$ is the daily number of birth in metropolitan france
- m_i is a rate that takes into account the mortality and the negative net migration in age group i
- $a_i = 1/(30.5 * \text{number of months in age group } i)$ is the daily ageing rate in age group i
- $doses^{nb}(t)$ is the daily number of doses administered to neonates.
- $\rho_i(t) = doses_i(t)/N_i(t)$ is the daily treatment rate in age group i , with $doses_i(t)$ with the daily number of doses administered in age group i .
- $p_{immu}(t) = \sum_{j=1}^3 \sum_{k=1}^2 R_{7,j,k}(t)/N_7(t)$ is the proportion of neonates immunised with maternal immunity.

The weekly number of HBER-RSV was determined by multiplying the number of individuals leaving the compartments $I_{i,j,k}$ in a week by the probability of HBER-RSV upon infection p_h . For individuals not treated, p_h is parameterised as:

$$\begin{cases} \exp\left(-\left(\varepsilon_0 + \varepsilon_{age} \cdot i\right)\right), & \text{for } i \in \{1, 2, 3, 4\} \\ h, & \text{for } i = 5 \end{cases}$$

Then p_h is multiplied by $1 - TE$ for individuals treated, where TE is the treatment effectiveness against hospitalisation.

7. Demographic dynamic

Daily births in metropolitan France were computed by interpolating monthly births in metropolitan France.² We derived the age-specific population for metropolitan France, spanning from 2005 to 2022, using the annual, department-level age data supplied by the Institut National de la Statistique et des Études Économiques (INSEE) to Santé Publique France. Additionally, we assumed there was the same number of individuals in age groups 0-2 months, 3-5 months, 6-8 months, 9-11 months. The mortality and migration rates were established prior to the Bayesian calibration to ensure alignment between the demographic dynamics in the model and those observed in the data for each age group.

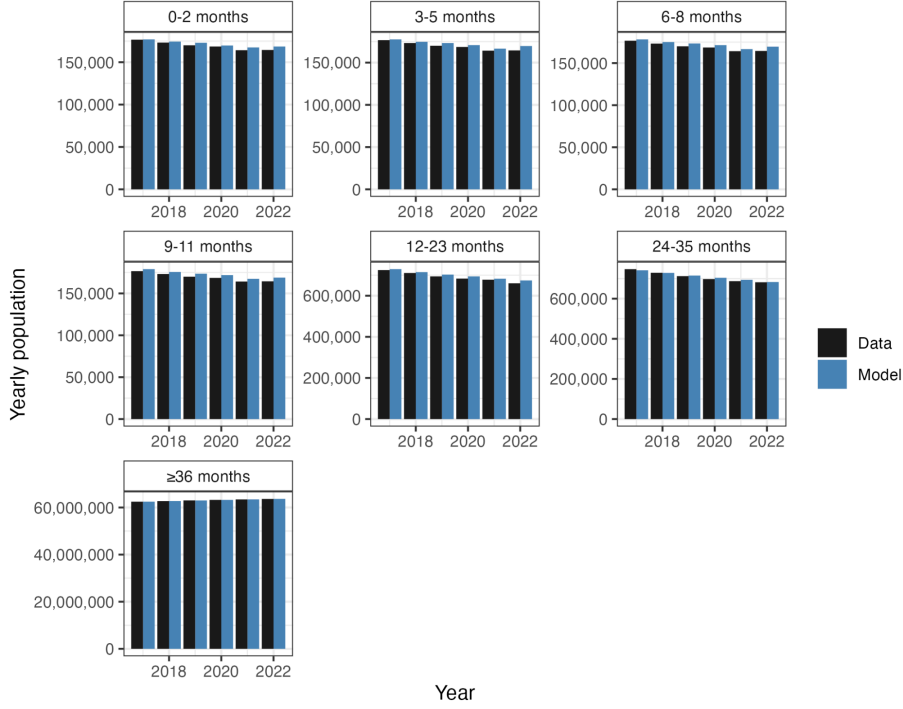

Figure S3: Demographic trends by age in metropolitan France. Observed population (black) by age and year and reconstruction of the population in the model (blue) between 2017 and 2022.

8. Contact matrix

From the contact matrix provided in Mistry et al.³ for age groups 0 year, 1 year, ..., 84 years and over, we constructed a contact matrix for age groups of our RSV model (0-2 months, 3-5 months, 6-8 months, 9-11 months, 1 year, 2 years, ≥ 3 years) as follows. Let us denote $c'_{k,l}$ the average number of daily contacts of an individual in age group k with the individuals in age group l , given by Mistry et al., with $k, l \in \{0, \dots, 84\}$. We will determine $c_{i,j}$ the average number of daily contacts of an individual in age group i with the individuals in age group j , with $i, j \in \{0 - 2m, \dots, 2y, \geq 3y\}$ (with abbreviation m for months and y for years).

We define a matrix \hat{c} by: $\hat{c}_{1y,1y} = c'_{1,1}$, $\hat{c}_{1y,2y} = c'_{1,2}$, $\hat{c}_{2y,1y} = c'_{2,1}$, $\hat{c}_{2y,2y} = c'_{2,2}$.

Let pop'_k the population in age group $k \in \{0, \dots, 84\}$. The average number of daily contacts between age groups k and l is $K'_{k,l} = c'_{k,l} pop'_k$. We set:

$$\hat{c}_{\geq 3y, \geq 3y} = \sum_{k,l \geq 3} K'_{k,l} / \sum_{k \geq 3} pop'_k, \quad \hat{c}_{1y, \geq 3y} = \sum_{l \geq 3} K'_{1,l} / pop'_1, \quad \hat{c}_{2y, \geq 3y} = \sum_{l \geq 3} K'_{2,l} / pop'_2,$$

And for $i, j \in \{0 - 2m, \dots, 9 - 11 m\}$, $\hat{c}_{i,j} = \frac{c'_{0,0}}{4}$, $\hat{c}_{i,1y} = \frac{c'_{0,1}}{4}$, $\hat{c}_{i,2y} = \frac{c'_{0,2}}{4}$,

$\hat{c}_{i \geq 3y} = \sum_{l \geq 3} K'_{0,l} / (4 \text{pop}'_0)$. Note that a contact matrix c must verify the condition $\text{pop}_i c_{i,j} = \text{pop}_j c_{j,i}$ for all i, j , i.e. the number of contacts between age groups i and j is the same as the number of contacts between age groups j and i . To ensure that the contact matrix c verify this property we set for all $i, j \in \{0 - 2m, \dots, 9 - 11 m, 1y, 2y, \geq 3y\}$:

$$c_{i,j} = \frac{\text{pop}_i \hat{c}_{ij} + \text{pop}_j \hat{c}_{ji}}{2 \text{pop}_i}.$$

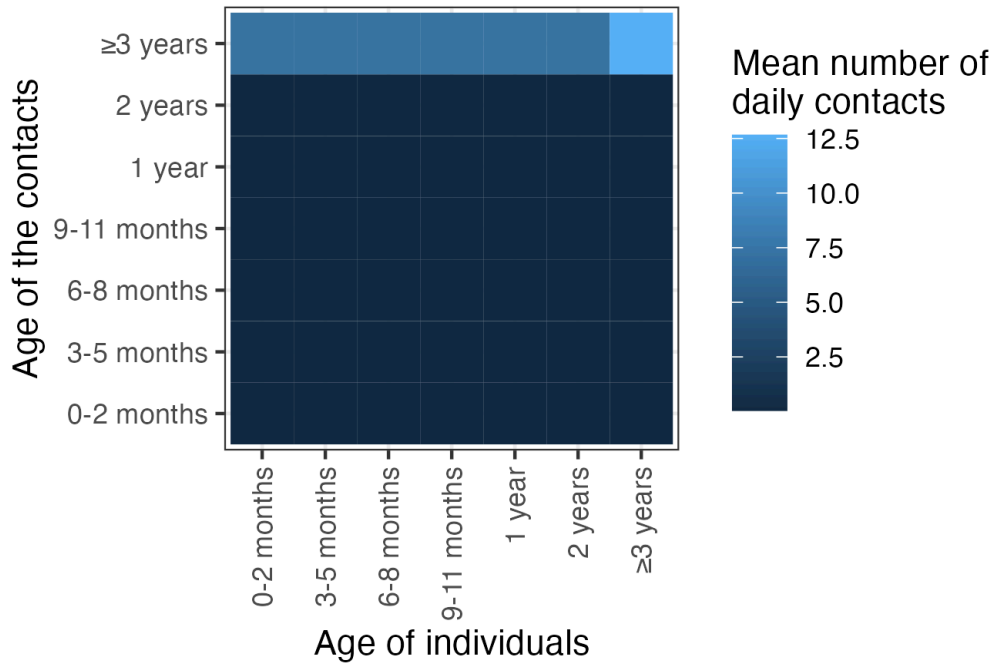

Figure S4: Contact matrix. Contact matrix used in the RSV model. The gradient of colour represents the average daily number of contacts an individual in each age group has with individuals in other age groups.

9. Description of transmission model parameters

Name	Symbol	Value / Priors	Estimation with calibration
Duration infectiousness	$1/\gamma$	7 days	Fixed ⁴
Waning of immunity after infection	$1/\omega$	9 months (sensitivity analysis: 6 months, 12 months)	Fixed ^{5,6}
Waning maternal immunity	$1/\omega_M$	2 months (sensitivity analysis: 1 month, 4 months)	Fixed
Reduction of susceptibility after 1 and 2 infections	λ_1, λ_2	0.76, 0.88	Fixed ⁷

Transmission rate minimum and maximum of the forcing seasonality	β_{min}, β_{max}	Uniform prior (0,3]	0.34 (0.337-0.344), 0.414 (0.411-0.417)
Day of the year corresponding to the maximum transmission rate (with January 1 as day 0)	t_{peak}	320 days	Fixed from the likelihood profile
Reduction transmission during summer holidays July 1 to August 31	μ_{school}	Uniform prior (0,1]	0.816 (0.798-0.831)
Reduction of transmission during lockdown corresponding to periods: - March 17-May 10, 2020 - Oct. 30 - Dec. 14, 2020 - April 3 - May 2, 2021	η_{lock}	Uniform prior (0,1]	0.707 (0.684-0.723)
Reduction of transmission during curfew corresponding to periods: - Dec.15, 2020-April 2, 2021 - May 3- June 19, 2021	η_{curfew}	Uniform prior (0,1]	0.902 (0.891-0.914)
Reduction of transmission during protective measure corresponding to periods between May 11, 2020 and June 30, 2022 outside lockdown and curfew periods	$\eta_{protect}$	Uniform prior (0,1]	0.946 (0.938-0.952)
Variation of transmission between September 1, 2022 and June 30, 2023	$\eta_{2022-2023}$	Uniform prior [0.9,1.5]	1.05 (1.04-1.06)
Variation of transmission between September 1, 2023 and June 30, 2024	$\eta_{2023-2024}$	Uniform prior [0.9,1.5]	1.08 (1.07-1.09)
Exponential decrease of severity under 1 year old	$\epsilon_0, \epsilon_{age}$	Uniform (0,10]	1.33 (1.29-1.37) 0.672 (0.654-0.689)
Severity in age group 1 year old	h	Uniform (0,1]	0.0054 (0.0051-0.0057)
Daily mortality/migration rates	m_1 m_2 m_3 m_4 m_5 m_6 m_7	0.000411 0.0000137 0.0000137 0.00000822 0 0 0.0000205	Determined before calibration using births and age-specific population data (Section Demographic Data).

Treatment effectiveness against hospitalisation	TE	Uniform (0,1]	0.73 (0.61-0.84)
Coefficient of adjustment of dispersion in likelihood	κ	Uniform (0,10]	0.54 (0.52-0.56)

Table S3: Parameters fixed and estimated in the RSV transmission model. The first column provides a description of the role of parameters, the second column the associated symbols, the third the value of the parameter when it is fixed or the prior of the parameter when it is calibrated to the data. The estimation of parameters is presented in the fourth column.

10. Likelihood and Markov chain Monte Carlo calibration

The model was initialised in January 1, 2005, with 1 infection per age group so that it could reach a steady state before being compared to the data. It was calibrated jointly to reconstruct the weekly HBER-RSV between August 2017-February 4, 2024 for age groups <24 months and our serological data. The likelihood is expressed as:

$$\prod_{a=0-23 \text{ months}} \prod_{t=t_1}^{t_f} \text{Neg}(\text{HBER}_{RSV}(t, a) \mid \text{HBER}_{RSV}^{\text{model}}(t, a)) \cdot \prod_{a=12-23 \text{ months}}^{\geq 36 \text{ months}} \text{Binom}(\text{Pos}(a) \mid N(a), p_{\text{sero}}^{\text{model}}(a)),$$

where $\text{Neg}(\cdot \mid x)$ is the negative binomial distribution of mean x and variance $x + x^{2-\kappa}$, where κ is being estimated, $\text{Binom}(\cdot \mid N, p)$ is the binomial distribution with parameter N and p . The terms $\text{HBER}_{RSV}(t, a)$ and $\text{HBER}_{RSV}^{\text{model}}(t, a)$ are respectively the reconstructed and modelled number of HBER-RSV during week t in age group a , t_1 is week 34 of 2017 and t_f week 5 of 2024. For age group a , $N(a)$ represents the total number of individuals screened for RSV seropositivity, while $\text{Pos}(a)$ denotes the count of those who tested positive. $p_{\text{sero}}^{\text{model}}(a)$ is the modelled proportion of individuals in age group a who either underwent at least one RSV infection or retained maternal immunity during the timeframe of the serological study.

Bayesian inference using the Markov chain Monte Carlo (MCMC) method is now widely used for calibration and parameter estimation in infectious disease modelling.^{5,8,9} We used the Metropolis within Gibbs MCMC algorithm, running two chains with the same initialisation each comprising 10,000 iterations. The algorithm was configured with a log-normal proposal distribution. To optimise the sampling efficiency, the standard deviation of this proposal was adaptively adjusted to target an acceptance rate of 0.24 over the first 5,000 iterations. We selected a burn-in of 2,500 iterations.

The credible intervals (CI) of the parameters were computed using the highest posterior density interval method.

If the date of the peak of seasonality is not fixed but estimated, we estimate values for t_{peak} , effectiveness and number of hospitalisations averted that are similar from those in our main analysis when t_{peak} is fixed. However, in this scenario, convergence of the MCMC is imperfect. Since results are similar, we prefer to report results for the scenario where t_{peak} is fixed and good MCMC convergence is obtained.

11. RSV seropositivity inferred by the model

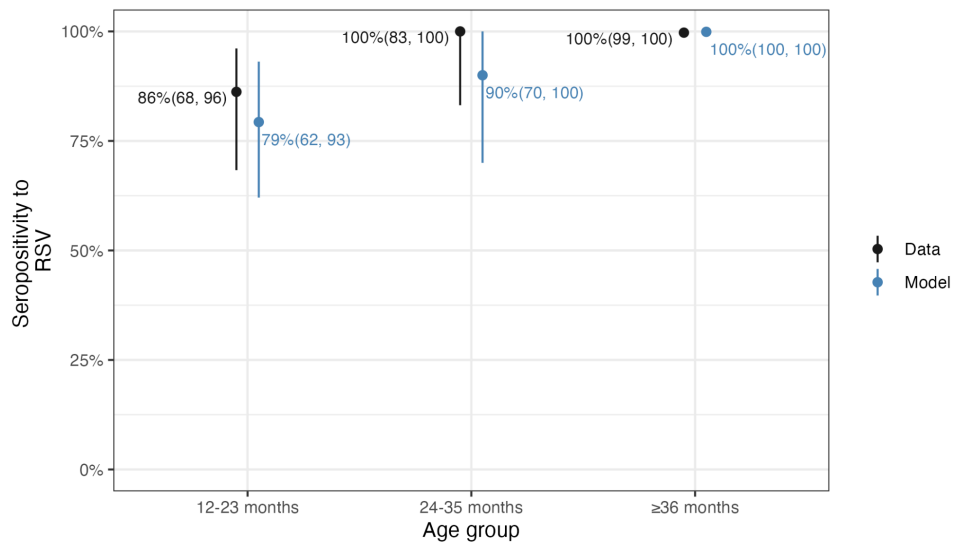

Figure S5: Model calibration to serological data. Observed (black) and predicted (blue) RSV seroprevalence between February and August 2020 by age group. Dots and the numbers outside parentheses are the median values. The black vertical bars and numbers in parentheses represent the 95% confidence interval of observed data and the blue vertical bar and numbers in parentheses represent the 95% quantiles of the model's observation process.

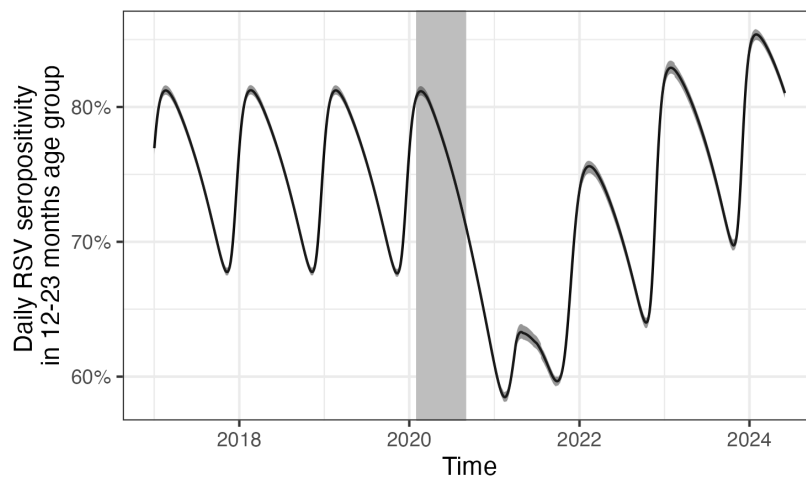

Figure S6: Evolution of RSV seropositivity between 2017 and 2024, accounting for the effect of COVID-19 non-pharmaceutical interventions. The graph illustrates the temporal trend of seropositivity among 12-23 months olds throughout our calibrated model simulation. The shaded grey rectangle corresponds to the timeframe of the serological study conducted between February 2020 and August 2020.

12. Model estimates

We estimated that RSV transmission was reduced by 18% (95% CI: 17%-20%), 29% (28%-32%), 10% (9%-11%), 5% (5%-6%) respectively during summer holidays, lockdowns, curfews, and other periods with protective measures (Figure S7A). Conversely, we estimated a slight rise in transmission rates during the 2022-2023 (5%, 4%-6%) and 2023-2024 (8%, 7%-9%) seasons. The probability of HBER-RSV upon RSV infection was estimated to rapidly decrease with age from 14% in 0-2 months to 7% in 3-5 months, 4% in 6-8 months, 2% in 9-11 months, and 0.5% in 12-23 months age groups (Figure S7B).

We assessed the seasonal incidence of RSV across different age groups defined as the ratio of the number of infections to the population size within each age group over a season. During the pre-COVID period, seasonal incidence was highest in the 0-5 months age group (around 60%). It fell to 44% in the 24-35 months age groups, before rising again to around 54% in those individuals aged ≥ 36 months, due to the greater number of contacts in this age group (Figure S7C). In 2020-2021, due to COVID-19 NPIs, the seasonal incidence dropped sharply in all age groups (e.g. 35% in the infants aged 0-5 months and 36% in the ≥ 36 months age group). After NPI relaxation, there was a rebound in infections, partly due to the decline in population immunity, with a seasonal incidence of 67% in infants aged 0-5 months in 2022-2023.

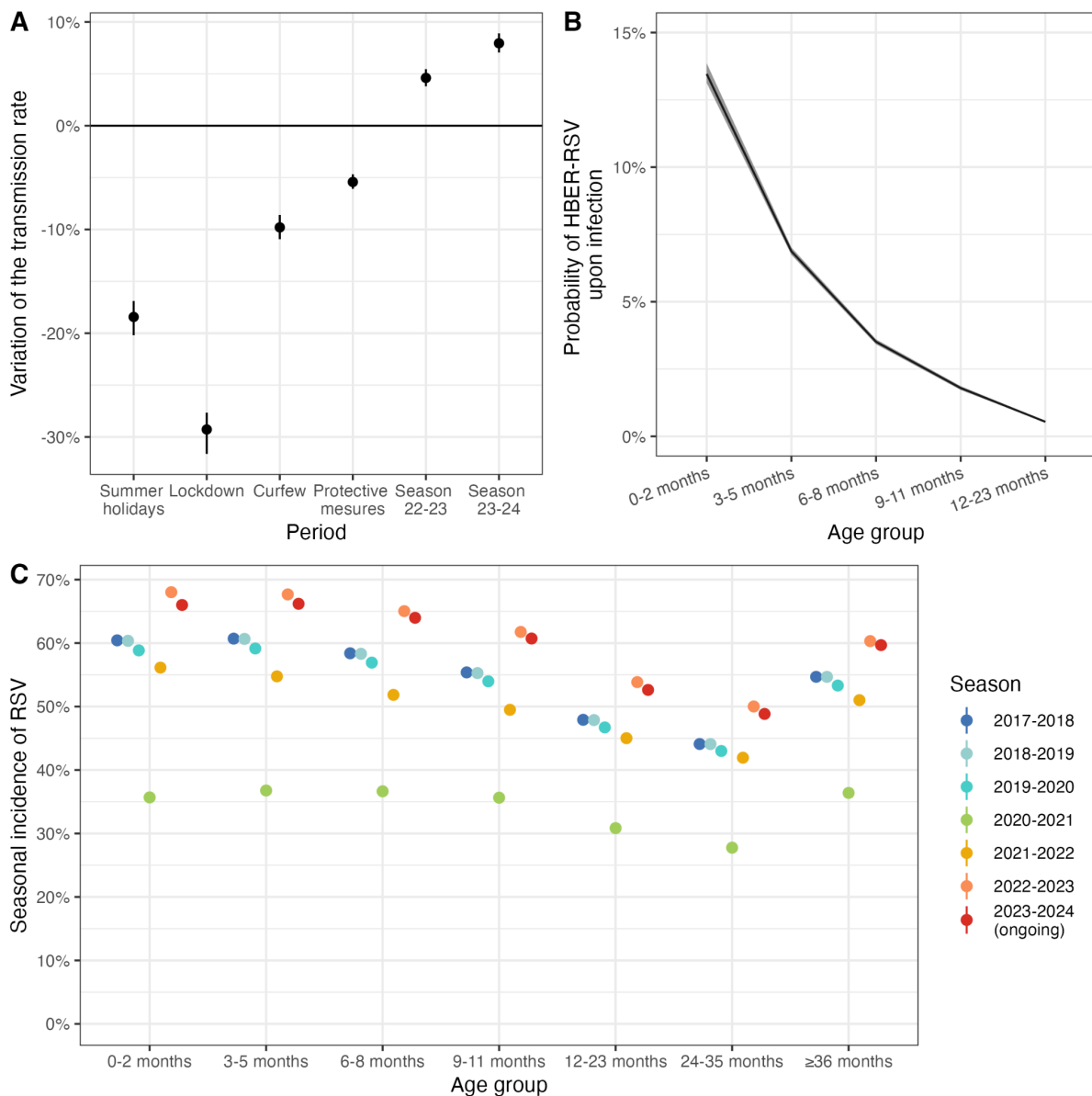

Figure S7: Model estimates of variations in transmission, severity by age and proportion of infections by age and season. (A) Variations in transmission rates estimated during summer holidays, lockdown, curfew, protective measures (mask, physical distancing,...), season 2022-2023 and season 2023-2024. The vertical bars represent the 95% credible interval. (B) Estimation of the probability of hospitalisation for RSV bronchiolitis following an emergency room visit (HBER-RSV) upon RSV infection in individuals with no prior infection or maternal immunity, categorised by age group. (C) Seasonal incidence of RSV by age and season. The seasonal incidence is defined as the ratio of the number of infections within an age group during a season to the average population size of that age group throughout the season. A season period is defined as spanning from week 34 of one year to week 33 of the following year. The season 2023-2024 is not over. The vertical bars represent the 95% credible interval.

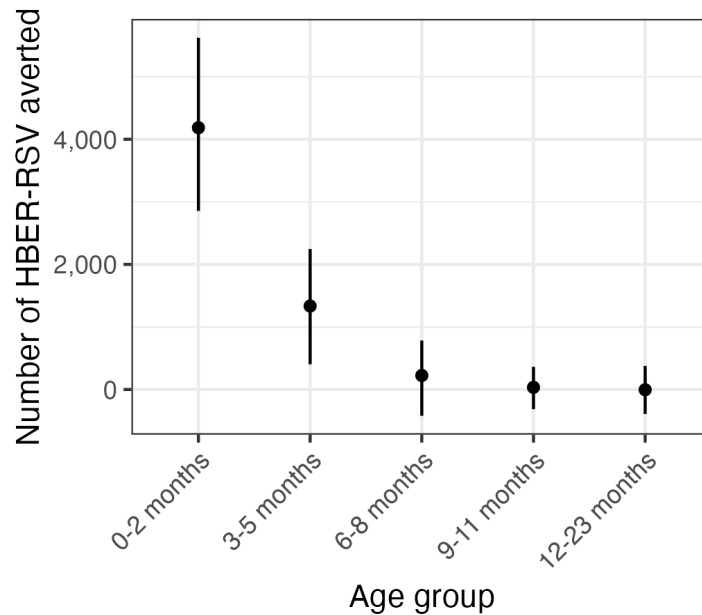

Figure S8: Averted HBER-RSV by age group. Estimation of the number of HBER-RSV by age group with nirsevimab treatment.

13. Sensitivity analysis

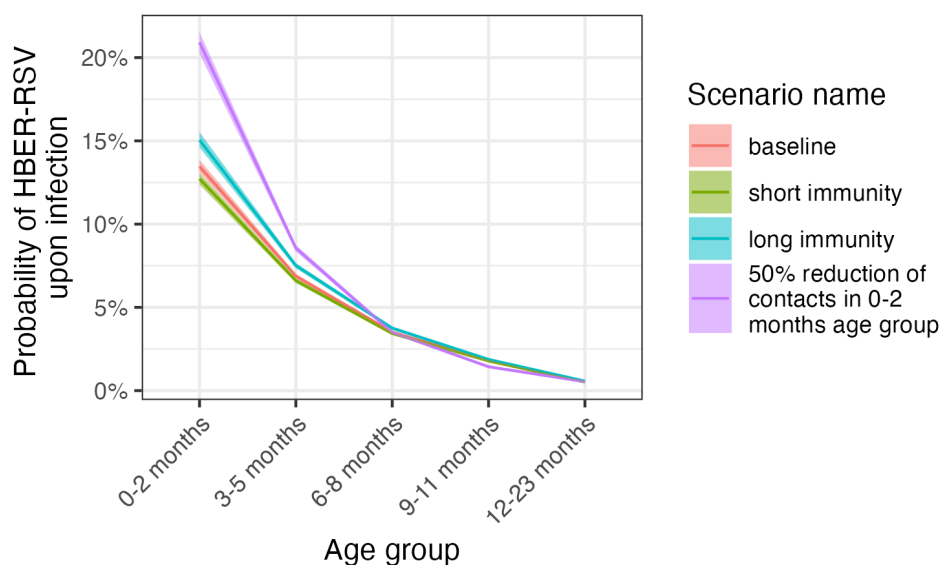

Figure S9: Sensitivity of estimates for RSV severity by age. Probability of HBER-RSV upon infection by age group with respect to sensitivity analysis, assuming that the peak of HBER-RSV reaches 90% of the peak of

HBer. Scenarios are: 2 month of maternal immunity and 9 months of immunity following infection (baseline); 1 month of maternal immunity and 6 months of immunity following infection (short immunity); 4 months of maternal immunity and 12 months of immunity following infection (long immunity); 50% reduction of contacts in 0-2 months age group.

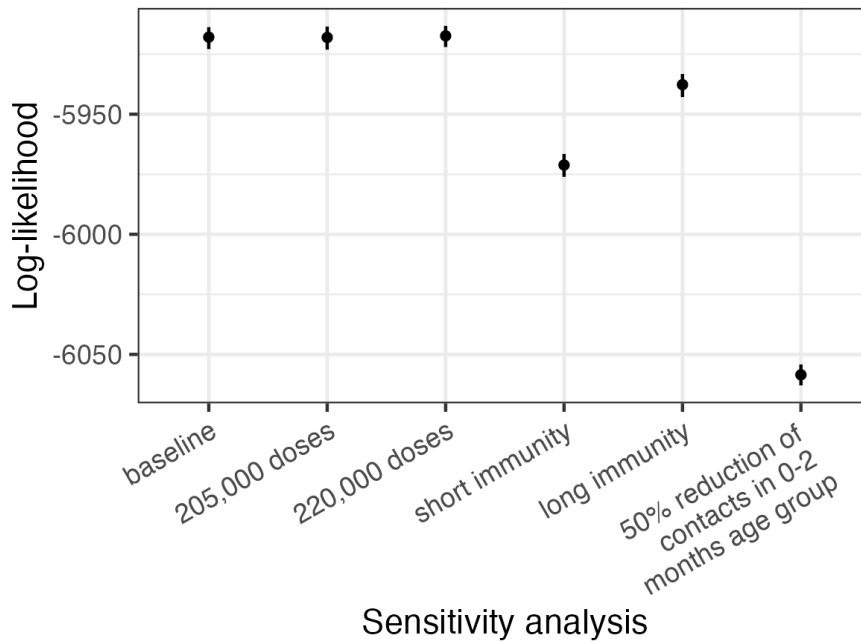

Figure S10: Log-likelihood of sensitivity analyses. Log-likelihood of the calibrated model to HBER-RSV (peak 90% scenario) for the different sensitivity analyses. The scenarios depicted in the x-axis are: 215,000 doses, 2 months of maternal immunity, 9 months of immunity following infection (baseline); 205,000 or 220,000 doses administered by January 31, 2024 (205,000 doses; 220,000 doses); 1 month of maternal immunity and 6 months of immunity following infection (short immunity); 4 months of maternal immunity and 12 months of immunity following infection (long immunity); 50% reduction of contacts in 0-2 months age group.

14. Proportion of individuals susceptible by age

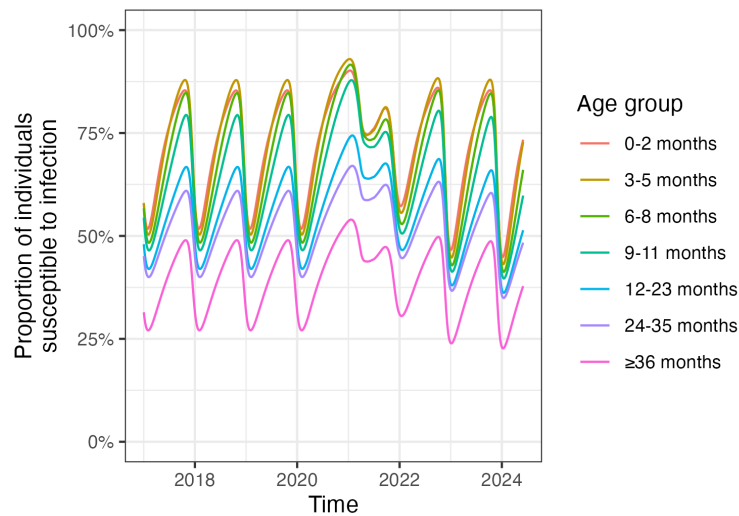

Figure S11: Proportion of individuals susceptible by age. Proportion of individuals susceptible to infection,

by age group, as reconstructed by the calibrated model. For each age group the number of individuals susceptible is computed as $S_1 + \lambda_1 S_2 + \lambda_1 \lambda_2 S_3$, where S_1 is the number of individual totally susceptible, S_2 the number of individuals with a reduction λ_1 of susceptibility and S_3 the number of individuals with a reduction $\lambda_1 \lambda_2$ of susceptibility.

References

- 1 Woudenberg T, Pelleau S, Anna F, *et al.* Humoral immunity to SARS-CoV-2 and seasonal coronaviruses in children and adults in north-eastern France. *EBioMedicine* 2021; **70**: 103495.
- 2 Harvey VC, Farand P. Monthly living births in metropolitan France. 2015. <https://www.insee.fr/fr/statistiques/serie/000436391>.
- 3 Mistry D, Litvinova M, Pastore Y Piontti A, *et al.* Inferring high-resolution human mixing patterns for disease modeling. *Nat Commun* 2021; **12**: 323.
- 4 Koltai M, Krauer F, Hodgson D, *et al.* Determinants of RSV epidemiology following suppression through pandemic contact restrictions. *Epidemics* 2022; **40**: 100614.
- 5 Hodgson D, Pebody R, Panovska-Griffiths J, Baguelin M, Atkins KE. Evaluating the next generation of RSV intervention strategies: a mathematical modelling study and cost-effectiveness analysis. *BMC Med* 2020; **18**: 348.
- 6 Ohuma EO, Okiro EA, Ochola R, *et al.* The natural history of respiratory syncytial virus in a birth cohort: the influence of age and previous infection on reinfection and disease. *Am J Epidemiol* 2012; **176**: 794–802.
- 7 Henderson FW, Collier AM, Clyde WA Jr, Denny FW. Respiratory-syncytial-virus infections, reinfections and immunity. A prospective, longitudinal study in young children. *N Engl J Med* 1979; **300**: 530–4.
- 8 Andronico A, Tran Kiem C, Paireau J, *et al.* Evaluating the impact of curfews and other measures on SARS-CoV-2 transmission in French Guiana. *Nat Commun* 2021; **12**: 1634.
- 9 Cauchemez S, Carrat F, Viboud C, Valleron AJ, Boëlle PY. A Bayesian MCMC approach to study transmission of influenza: application to household longitudinal data. *Stat Med* 2004; **23**: 3469–87.