



**HAL**  
open science

# Single locus phosphoproteomics reveals phosphorylation of RPA-1 is required for generation of single-strand DNA following a break at a subtelomeric locus

Emilia Mclaughlin, Annick Dujancourt-Henry, Thibault Chaze, Quentin Gai Gianetto, Mariette Matondo, Michael D Urbaniak, Lucy Glover

## ► To cite this version:

Emilia Mclaughlin, Annick Dujancourt-Henry, Thibault Chaze, Quentin Gai Gianetto, Mariette Matondo, et al.. Single locus phosphoproteomics reveals phosphorylation of RPA-1 is required for generation of single-strand DNA following a break at a subtelomeric locus. 2022. pasteur-04093539

**HAL Id: pasteur-04093539**

**<https://pasteur.hal.science/pasteur-04093539>**

Preprint submitted on 10 May 2023

**HAL** is a multi-disciplinary open access archive for the deposit and dissemination of scientific research documents, whether they are published or not. The documents may come from teaching and research institutions in France or abroad, or from public or private research centers.

L'archive ouverte pluridisciplinaire **HAL**, est destinée au dépôt et à la diffusion de documents scientifiques de niveau recherche, publiés ou non, émanant des établissements d'enseignement et de recherche français ou étrangers, des laboratoires publics ou privés.



Distributed under a Creative Commons Attribution - NoDerivatives 4.0 International License

1 **Single locus phosphoproteomics reveals phosphorylation of RPA-1 is required for**  
2 **generation of single-strand DNA following a break at a subtelomeric locus.**

3  
4 Emilia McLaughlin<sup>1,2#</sup>, Annick Dujancourt-Henry<sup>1</sup>, Thibault Chaze<sup>3</sup>, Quentin Gai Gianetto<sup>3,4</sup>,  
5 Mariette Matondo<sup>3</sup>, Michael D Urbaniak<sup>5</sup>, Lucy Glover<sup>1\*</sup>

6  
7 <sup>1</sup>Institut Pasteur, Université Paris Cité, Trypanosome Molecular Biology, Department of  
8 Parasites and Insect Vectors, F-75015, Paris, France.

9 <sup>2</sup>Sorbonne Université, Collège doctoral, F-75005 Paris, France

10 <sup>3</sup>Institut Pasteur, Université Paris Cité, Proteomics Platform, Mass Spectrometry for Biology  
11 Unit, Centre National de la Recherche Scientifique, UAR 2024, 75015 Paris, France.

12  
13 <sup>4</sup>Institut Pasteur, Université Paris Cité, Bioinformatics and Biostatistics HUB, 75015 Paris,  
14 France.

15  
16 <sup>5</sup>Division of Biomedical and Life Sciences, Faculty of Health and Medicine, Lancaster  
17 University, Lancaster, UK.

18  
19 # Present address:

20  
21 \* Corresponding author: Lucy Glover - [lucy.glover@pasteur.fr](mailto:lucy.glover@pasteur.fr)

22  
23 **Keywords:** Phosphoproteomics, *Trypanosoma brucei*, DNA damage

24  
25  
26 **Abstract:** 164 words

27  
28  
29  
30  
31  
32

## 33 **Abstract**

34 Damage to the genetic material of the cell poses a universal threat to all forms of life. Central  
35 to the DNA damage response (DDR) is a phosphorylation signalling cascade that leads to the  
36 co-ordination of the cellular response to a DNA break. Identifying the proteins that are  
37 phosphorylated is crucial to understanding the mechanisms underlying this DDR. We have used  
38 SILAC-based quantitative phosphoproteomics to profile changes in phosphorylation site  
39 abundance following a single double strand break (DSB) at a chromosome internal locus and  
40 the subtelomeric bloodstream form expression site in *Trypanosoma brucei*. We report >6500  
41 phosphorylation sites, including a core set of 211 DSB responsive phosphorylation sites. Along  
42 with phosphorylation of canonical DNA damage factors, we find that there is a striking  
43 distinction between the proteins phosphorylated in response to a chromosome internal DSB and  
44 one at the active BES and describe a single phosphorylation event on Replication factor A  
45 (RPA) 1 that is required for efficient resection at a bloodstream form expression site.

46

## 47 **Introduction**

48 One of the most toxic insults to the genome is a DNA double strand break (DSB), where breaks  
49 occur simultaneously in the phosphate backbone of two complementary DNA strands. DSBs in  
50 the DNA can arise due to endogenous processes in the cell, such as replication fork collapse or  
51 stalling, and can also result from exogenous agents, such as chemicals or ionising radiation  
52 (Mehta and Haber 2014). DSB repair (DSBR) is a coordinated program of events initiated by a  
53 signalling cascade, which protein phosphorylation lies at the heart of. DSBs are detected by the  
54 MRN complex (MRE11-RAD50-NBS1) (Marechal and Zou 2013), and subsequently ATM  
55 (ataxia-telangiectasia mutated) and ATR kinase (ATR and Rad3-related), the master regulators  
56 of the DNA damage response (DDR), are recruited to the site of damage (Marechal and Zou  
57 2013). This initiates a phosphorylation cascade in the cell with some 900 substrates modified  
58 (Matsuoka et al. 2007). One of the key substrates of ATM is the histone variant H2AX, where  
59 S139 is phosphorylated (termed  $\gamma$ H2AX), and this is an early marker of the DSBR in mammals  
60 (Rogakou et al. 1998; Xiao et al. 2009).  $\gamma$ H2AX spreads along large regions of chromatin fibre  
61 bi-directionally from the DSB site (Matsuoka et al. 2007) which aids the recruitment of  
62 chromatin remodelling factors, allows DNA damage proteins to access the DSB (Van and  
63 Santos 2018) and concentrates repair factors at the damaged site (Celeste et al. 2003).

64 Understanding phosphorylation cascades has been driven by Stable Isotopic Labelling  
65 of Amino acids in Cell culture (SILAC) (Ong et al. 2002) based quantitative  
66 phosphoproteomics (Bennetzen et al. 2010; Bensimon et al. 2010; Matsuoka et al. 2007; Zhou

67 et al. 2016). SILAC phosphoproteomics has identified over 900 phosphorylation sites  
68 associated with ionizing radiation induced DNA damage, revealing a series of interconnected  
69 networks in the DDR including modules of proteins associated with DNA repair, replication,  
70 and chromatin modifications (Matsuoka et al. 2007). Over 70% of the phosphorylation sites  
71 identified are targets of the ATM kinase, and many of these substrates are themselves kinases,  
72 highlighting the central role of the phosphorylation cascade in the DDR.

73 Human African Trypanosomiasis (HAT) is a fatal vector borne disease caused by the  
74 protozoan parasite *Trypanosoma brucei*. In the mammalian host the parasite is found in the  
75 bloodstream, adipose tissue (Trindade et al. 2016) and skin (Caljon et al. 2016; Capewell et al.  
76 2016). Here, the parasite is exposed to attack by the host immune system and is protected by a  
77 dense variant surface glycoprotein (VSG) coat, which is periodically exchanged by antigenic  
78 variation (Cross 1975; Horn 2014). *VSG*'s are exclusively expressed from one of 15  
79 subtelomeric bloodstream form expression sites (BES) (Hertz-Fowler et al. 2008), however the  
80 majority of *VSG* genes are located in arrays in the subtelomeric regions of the megabase  
81 chromosomes, and also occasionally at chromosome internal regions (Berriman et al. 2005).  
82 There has been much debate into what triggers a *VSG* switch with DSBs (Boothroyd et al. 2009;  
83 Glover, Alford, and Horn 2013), replication-derived fragility from the early replication of the  
84 BES (Benmerzouga et al. 2013; Devlin et al. 2016) or the formation of RNA:DNA hybrids  
85 (Briggs et al. 2018; Nanavaty et al. 2017) all being implicated. In *T. brucei* repair occurs  
86 predominantly via homologous recombination (HR) (Glover, McCulloch, and Horn 2008), but  
87 microhomology mediated end joining also makes a significant contribution at the active BES  
88 (Glover, Alford, and Horn 2013). Within the HR pathway, sequence diversity amongst the  
89 genes facilitating repair suggesting functional divergence within the pathway as well (Dobson  
90 et al. 2011).

91 During the DNA damage repair cycle the G<sub>2</sub>/M checkpoint prevents division of  
92 unrepaired DNA and preserving genome integrity. Although trypanosomes do show cells  
93 arrested in G<sub>2</sub>/M following a DSB, some cells do continue to replicate and divide their DNA  
94 with a DNA break, which suggests a level of tolerance to DNA damage greater than that seen  
95 in other eukaryotes (Glover et al. 2007; Glover et al. 2019), perhaps aiding homology searching  
96 for antigenic variation. Early recognition and processing of a DSB via the MRN complex  
97 (MRE11, RAD50, NBS1 in mammals / XRS2 in *S. cerevisiae*) is important for both detection  
98 and signalling of a DSB. In *Trypanosoma brucei* and *Leishmania*, MRE11 maintains genomic  
99 integrity but does not affect the rate of VSG switching in the former (Laffitte et al. 2014; Laffitte  
100 et al. 2016; Robinson et al. 2002; Tan, Leal, and Cross 2002). However, RAD50 and MRE11

101 were shown to play distinct roles at the subtelomeric regions, with MRE11 required for efficient  
102 resection and both MRE11 and RAD50 promote recombination using longer stretches of  
103 homology (Mehnert et al. 2021).

104 Several DNA damage linked proteins directly influence antigenic variation. ATR  
105 mediates signal transduction in trypanosomes (Marin et al. 2020) and loss leads to increased  
106 VSG switching (Black et al. 2020), two RecQ-like helicases have been identified and mutants  
107 of one, RECQ2, show elevated VSG switching by telomere recombination and VSG gene  
108 conversion events (Devlin et al. 2016). RAD51, the primary recombinase in DNA repair, is  
109 required for homology searching and DNA strand exchange and is loaded onto single strand  
110 DNA by BRCA2, displacing RPA (Lo et al. 2003; Wong et al. 1997). In *T. brucei*, BRCA2 is  
111 essential for HR, DNA replication, cell division and antigenic variation (Hartley and  
112 McCulloch 2008; Trenaman et al. 2013), while RAD51 essential for HR and *rad51* null mutants  
113 have impaired, VSG switching (Conway et al. 2002; Glover and Horn 2014; Kim and Cross  
114 2010; McCulloch and Barry 1999). In trypanosomes, five RAD51-related proteins DMC1,  
115 RAD51-3, 4, 5, and 6 are important for DSBR, but only RAD51-3 contributes to VSG switching  
116 (Proudfoot and McCulloch 2005). Antigenic variation occurs mainly by gene conversion (GC)  
117 events, where the active VSG is deleted and replaced by a silent donor (De Lange et al. 1983;  
118 Myler et al. 1985; Pays 1985; Robinson et al. 1999), but crossover switching events, where two  
119 VSGs are exchanged, have also been observed (Rudenko et al. 1996; Aitchison et al. 2005;  
120 Pays 1985; Pays et al. 1983). The RTR complex which includes the RecQ-family helicase, a  
121 Topoisomerase III $\alpha$ , and RMI1/2 suppresses these mitotic crossover and removes recombination  
122 intermediates (Mankouri and Hickson 2007). In trypanosomes VSG gene conversion and cross  
123 over events can be suppressed the RTR complex components *Tb*TOPO3 $\alpha$  and *Tb*RMI1 or act  
124 in concert with RAD51 and RMI1 (Kim and Cross 2010, 2011).

125 Despite the importance of DSBR in evasion of the host immune system only one DNA  
126 damage associated phosphorylation site has been identified in *T. brucei*, that of  $\gamma$ H2A (Glover  
127 and Horn 2012). In *T. brucei*, H2A Thr130 is phosphorylated in response to a DSB and  
128 colocalizes with RAD51 and RPA repair foci, typically during S or G2-phases of the cell cycle.  
129 The PTM of histones and non-histone proteins play a central role in the initiation and execution  
130 of the repair response (von Stechow and Olsen 2017; Price and D'Andrea 2013). In *T. brucei*  
131 histone acetyltransferase HAT3, which acetylates histone mark H4K4 (Siegel et al. 2008), and  
132 histone deacetylase SIR2rp1 (Alsford et al. 2007) act in an acetylation and deacetylation cycle  
133 influencing RAD51 foci assembly and disassembly, respectively (Glover and Horn 2014).

134 HAT3 also suppresses VSG switching (Glover and Horn 2014) alluding to specific chromatin  
135 marks that regulate DNA recombination and VSG switching.

136 Here, use a quantitative single-locus phosphoproteomic approach to characterise changes  
137 in phosphorylation site abundance in response to a DSB at (i) a chromosome internal locus and  
138 (ii) the active BES. We found that there is a striking distinction between the proteins  
139 phosphorylated in response to a chromosome internal DSB and one at the active BES. Here we  
140 show that Histone H2A is phosphorylated at two additional positions in response to a DSB and  
141 that RPA-1 phosphorylation is differentially required for efficient resection at a chromosome  
142 internal versus subtelomeric break.

143

## 144 **Materials and Methods**

### 145 Trypanosome strains and culturing

146 *T. brucei* Lister 427 cell lines were grown in HMI-11 medium at 37.4 °C (74) with 5% CO<sub>2</sub> and  
147 the density of cell cultures measured using a haemocytometer. Transformation of cell lines was  
148 carried out by centrifuging 2.5 x 10<sup>7</sup> cells at 1000 g for 10 minutes at room temperature. The  
149 cell pellet was resuspended with 10 µg linearized DNA in 100 µl warm cytomix solution (75),  
150 placed in a cuvette (0.2 cm gap) and transformed using a Nucleofector™ (Lonza) (X-001  
151 function. Transfected cells were recovered in 36 ml of warm HMI-11 at 37 °C for 4 - 6 hours,  
152 after which cells were plated out in 48 well plates with the required drug selection. G418  
153 selection was carried out at 2 µg/ml, puromycin at 2 µg/ml, blasticidin at 10 µg/ml and  
154 tetracycline at 1 µg/ml. Puromycin, phleomycin, hygromycin, blasticidin and G418 selection  
155 was maintained at 1 µg/ml. The VSG<sup>up</sup> cell line has been described previously (Glover, Alford,  
156 and Horn 2013) and the <sup>1</sup>HR stain in (Glover, McCulloch, and Horn 2008).

157

### 158 Generation of RPA-1 mutant cell lines

159 In order to generate the <sup>1</sup>HRRPA-1<sup>S5A</sup> cell line, the <sup>1</sup>HR cell line was first transfected with 10  
160 µg pRPA1<sup>S5A</sup>BLA, digested with NotI and KpnI and phenol/chloroform extracted. Successful  
161 integration of the construct was confirmed in the resulting clones by extraction of genomic  
162 DNA and amplification using the primer set RPA-1 5' F primer and BlaNco1 R. The presence  
163 of the RPA-1<sup>S5A</sup> mutation was confirmed by sequencing of the PCR product (Eurofins  
164 Genomics). Two correct single allele mutants' clones were picked and then transfected with  
165 10 µg pRPA1<sup>S5A</sup>NEO digested with NotI and KpnI and phenol /chloroform extracted. Genomic  
166 DNA was extracted from the resulting clones, and the mutant allele amplified using the primer  
167 set RPA1 5'F and Neo.2 R. The resulting PCR product was sequenced (Eurofins Genomics) to

168 confirm the point mutation and a pair of biological clones used for downstream analysis. The  
169 VSG<sup>up</sup>RPA-1<sup>S5A</sup> cell line was made in exactly the same way but using the VSG<sup>up</sup> cell line.

170

171 Quantitative single strand DNA resection assay

172 Quantification of ssDNA by qPCR was carried out using an adapted version of an established  
173 protocol (Mehnert et al. 2021; Zierhut and Diffley 2008). In brief, DNA was harvested at 0, 6  
174 and 12 h following growth in 1 µg/ml tetracycline. 500 ng of extracted DNA was digested with  
175 either HindIII or mock digested (no enzyme) overnight at 37 °C. For the <sup>1</sup>HR and <sup>1</sup>HR RPA-  
176 1<sup>S5A</sup> cell lines, qPCR was carried out using the RFP.2 F and RFP.2 R primers. For the VSG<sup>up</sup>  
177 and VSG<sup>up</sup>RPA-1<sup>S5A</sup> cell lines, the qPCR reaction was carried out using the VSG21b F and  
178 VSG21bR primers. Luna Universal qPCR master mix (New England Biolabs) was used with  
179 600 pM primer mix and 5 ng DNA per reaction. The PCR cycling conditions were: 95 °C for 3  
180 minutes, and then 40 cycles of 95 °C for 10s and 55 °C for 30s on a thermal cycler. The  $\Delta c_q$   
181 was calculated by subtracting the average  $c_q$  of the mock digest from the digested  $c_q$ . % ssDNA  
182 was calculated using the formula: % resection =  $100/[(1+2^{\Delta c_q})/2]$ , assuming 100% efficiency of  
183 the *I-SceI* meganuclease. 3 technical replicates were carried out for each experiment and  
184 statistical analysis was carried out in Excel and GraphPad Prism version 9.

185

186 VSG-seq analysis

187 For both the VSG<sup>up</sup> and VSG<sup>up</sup>RPA-1<sup>S5A</sup> cell lines,  $5 \times 10^7$  cells were harvested 0- and 7-days  
188 post growth in 1 µg/ml tetracycline, in triplicate, and RNA extracted. First strand synthesis was  
189 carried out using 500 ng of RNA, SuperScript® IV reverse transcriptase (ThermoFisher) and  
190 200nM of the ‘All-VSG 3’-UTR’ primer (Mugnier, Cross, and Papavasiliou 2015) that binds  
191 specifically to the conserved 14-mer in the VSG 3’ UTR. The product was cleaned up using  
192 AmPureXP beads (Beckman Coulter). VSG cDNA was then amplified by PCR using 1 µg of  
193 cDNA, 0.2 mM dNTPs, 1 x PCR buffer, Phusion HF DNA polymerase (NEB), 200 nM of the  
194 spliced leader (SL) forward primer and 200 nM of the SP6-14mer reverse primer (Mugnier,  
195 Cross, and Papavasiliou 2015). The PCR conditions were: 5 cycles of: 94°C for 30s, 50°C for  
196 30s and 72°C for 2 minutes, followed by 18 cycles of: 94 °C for 30s, 55 °C for 30s and 72 °C  
197 for 2 minutes carried out on a thermal cycler machine. The VSG PCR products were then  
198 cleaned up using AmpPureXP beads (Beckman Coulter) according to manufacturer’s protocols.  
199 Sequencing was carried out using a minimum of 4 µg product per sample at Beijing Genomics  
200 Institute (BGI) using the BGISEQ-500 platform in paired end mode. The number of million  
201 reads per library was: 4.01 for VSG<sup>up</sup> uninduced replicate 1, 4.02 for VSG<sup>up</sup> uninduced replicate

202 2, 4.00 for VSG<sup>up</sup> uninduced replicate 3, 4.02 for VSG<sup>up</sup> induced replicate 1, 4.00 for VSG<sup>up</sup>  
203 induced replicate 2, 4.03 for VSG<sup>up</sup> induced replicate 3, 3.90 for VSG<sup>up</sup>RPA-1<sup>S5A</sup> uninduced  
204 replicate 1, 4.01 for VSG<sup>up</sup>RPA-1<sup>S5A</sup> uninduced replicate 2, 4.00 for VSG<sup>up</sup>RPA-1<sup>S5A</sup>  
205 uninduced replicate 3, and 4.01 for VSG<sup>up</sup>RPA-1<sup>S5A</sup> induced replicate 1, 3.97 for VSG<sup>up</sup>RPA-  
206 1<sup>S5A</sup> induced replicate 2 and 3.78 for VSG<sup>up</sup>RPA-1<sup>S5A</sup> induced replicate 3. Reads were aligned  
207 to the *T. brucei* Lister 427 genome (Müller et al. 2018) with the BES's and minichromosomal  
208 VSGs added from the VSGnome (Cross, Kim, and Wickstead 2014; Hertz-Fowler et al. 2008))  
209 using Bowtie2 (Langmead and Salzberg 2012) with –very-sensitive parameters. BAM files  
210 were generated using samtools (Li et al. 2009). The overall alignment was: 98.82% for VSG<sup>up</sup>  
211 uninduced replicate 1, 98.88% for VSG<sup>up</sup> uninduced replicate 2, 99.13% for VSG<sup>up</sup> uninduced  
212 replicate 3, 98.56% for VSG<sup>up</sup> induced replicate 1, 98.32% for VSG<sup>up</sup> induced replicate 2,  
213 98.57% for VSG<sup>up</sup> induced replicate 3, 99.06% for VSG<sup>up</sup>RPA-1<sup>S5A</sup> uninduced replicate 1,  
214 98.93% for VSG<sup>up</sup>RPA-1<sup>S5A</sup> uninduced replicate 2, 98.89% for VSG<sup>up</sup>RPA-1<sup>S5A</sup> uninduced  
215 replicate 3, and 98.19% for VSG<sup>up</sup>RPA-1<sup>S5A</sup> induced replicate 1, 98.09% for VSG<sup>up</sup>RPA-1<sup>S5A</sup>  
216 induced replicate 2 and 97.64% for VSG<sup>up</sup>RPA-1<sup>S5A</sup> induced replicate 3. Reads aligning to each  
217 transcript were acquired using featureCounts (Liao, Smyth, and Shi 2014) and EdgeR  
218 (Robinson, McCarthy, and Smyth 2010) was used to perform differential expression analysis  
219 on all genes. The R script used to generate volcano and genome plots and perform differential  
220 genome analysis can be found in the thesis annex figure 5 and is adapted from (Mehnert et al.  
221 2021)

222

## 223 HMI-9 SILAC medium

224 For all proteomic analysis, HMI-9 SILAC medium (Urbaniak, Martin, and Ferguson 2013)- L-  
225 Arginine and – L-Lysine (Gibco , reference 074-91211A) was used. One 17.91g pot used to  
226 make up 1L of medium by the addition of 900 ml H<sub>2</sub>O, 2 g sodium bicarbonate (Sigma) and 14  
227 µl of beta-mercaptoethanol and the mixture stirred for 1 h at room temperature. The pH was  
228 adjusted to 7.3, and the medium filtered using a 0.2 µM filter. The following components were  
229 added to the filtered medium: 10 ml of glutaMAX (ThermoFisher), 100 ml filter dialysed  
230 SILAC FBS (3 kda molecular weight cut off) (DC biosciences) Gibco, 5 ml Pen/ strep (5000  
231 U/ml penicillin and 5000 µg/ ml streptomycin) and heavy or light labelled L-Arginine and L-  
232 Lysine to the concentrations stated in table 6 to make heavy and light medium, respectively.

233



Amino acid	Label	Source	Mw	Final concentration in HMI-9
L-Arginine (R0)	Light	Sigma	210.6	25.8 mg/l
L-Arginine (R6- <sup>13</sup> C <sub>6</sub> )	Heavy	Sigma	216.6	25.9 mg/l
L-Lysine (K0)	Light	Sigma	182.6	43.8 mg/l
L-Lysine (K4- <sup>2</sup> H <sub>4</sub> )	Heavy	Sigma	223.1	53.5 mg/l

234 Table 1. The concentration of light and heavy labelled L-Arginine and L-Lysine used to  
235 supplement both IMDM and HMI-9 SILAC medium.

236

237 Assessing incorporation of the stable isotope label

238 To assess incorporation of the isotope label, the INT and VSG<sup>up</sup> cell lines were seeded in  
239 'heavy', and 'light' labelled SILAC HMI-9 and after 7 days  $1 \times 10^8$  cells harvested from each  
240 cell culture. Samples were extracted by FASP (see section 5.3) and processed for Mass  
241 Spectrometry as described below.

242

243 Phosphoproteomic experimental set up

244 For preparation of samples for proteomic and phosphoproteomic analysis, SILAC adapted INT  
245 and VSG<sup>up</sup> cell lines were seeded in SILAC 'heavy' and 'light' medium and cells grown in  
246 'heavy' medium were induced using 1  $\mu\text{g}$  /ml of tetracycline for 12 h. For each experimental  
247 condition, a label swap replicate was carried (induced cells grown in 'light' media and  
248 uninduced in 'heavy' media). Approximately  $3 \times 10^8$  cells were harvested from each culture  
249 condition by centrifugation at  $1,000 \times g$  for 10 minutes at 4 °C. The supernatant was removed,  
250 and the cell pellet resuspended in 200  $\mu\text{l}$  ice cold PBS and transferred to a microcentrifuge tube,  
251 where it was centrifuged at  $12,000 \times g$  for 15s and the supernatant discarded. The cell pellet  
252 was lysed at  $0.5 \times 10^9$  cells/ml in ice-cold lysis buffer (0.1 mM TLCK , 1  $\mu\text{g}$ /ml Leupeptin, 1x  
253 Phosphatase Inhibitor Cocktail II tablet (Calbiochem), 1 mM PMSF, 1 mM Benzamidine) and  
254 incubated at room temperature for 5 min, with cell lysis was verified by microscopy. Cell  
255 lysates were then stored at -80 °C before further processing.

256

257 FASP protocol

258 The preparation of peptides for Mass Spectrometry (MS) analysis was carried out using FASP  
259 (Wisniewski et al. 2009) that has been optimized for *T. brucei* (Urbaniak et al. 2013). For the  
260 four samples generated for investigation of the DSB response, the total amount of protein

261 concentrate was 1 mg and 2 mg of protein for each of the <sup>1</sup>HR label swap replicates, and 0.89  
262 and 0.62 mg of protein for each of the VSG<sup>up</sup> replicates. For digestion of peptides, the  
263 concentrated sample was removed from the ultra-centrifugal filter and a 1:50 ratio of mass  
264 spectrometry grade Trypsin Gold (Promega) added to the sample which was incubated with  
265 shaking for > 12 hours at 37 °C in a thermal heat block. Trypsin digestion was inhibited by  
266 adding 0.1% formic acid (FA) to the digest.

267

#### 268 Peptide desalting

269 Peptides were desalted using a Sep-Pak C18 SPE cartridge (Waters) using a vacuum manifold  
270 according to manufacturer instructions. All buffers were freshly prepared. Briefly, C18 phase  
271 (Sep-Pak, Waters) was activated in methanol, rinsed once in 80% ACN 0.1% FA, washed thrice  
272 in 0.1% FA. The sample was then loaded onto the cartridge twice. Resin was washed thrice in  
273 0.1% FA and peptides were eluted in 50% ACN 0.1% FA. The resulting sample was dried in a  
274 SpeedVac vacuum concentrator (ThermoFisher) until 50 µl remained and then transferred to a  
275 nano LC tube (ThermoFisher) and dried by lyophilization.

276

#### 277 Phosphopeptide enrichment

278 Phosphopeptide enrichment and Mass Spectrometry (MS) was carried out at the Mass  
279 Spectrometry for Biology Utechs (MSBio) platform at Institut Pasteur. Phosphopeptide  
280 enrichment was performed using a GELoader spin tip using Empore<sup>TM</sup> C8 (3M) prepared for  
281 StageTip (Rappsilber, Mann, and Ishihama 2007) and washed sequentially with 100% MeOH  
282 and 30% ACN, 0.1% trifluoroacetic acid (TFA). Before the enrichment step, 10 mg/mL TiO<sub>2</sub>  
283 slurry (Sachtopen-NP TiO<sub>2</sub>, 5 µm, 300 Å, Sachtleben) was prepared in 30% ACN, 0.1% TFA  
284 and introduced into the GELoader C8 spin tip. The spin column was packed by centrifugation  
285 at 100 × g and then equilibrated loading buffer (80% ACN, 6% TFA, 1 M glycolic acid) before  
286 loading lyophilised tryptic peptides resuspended loading buffer at a ratio of 1:5 peptides to  
287 beads. An aliquot of tryptic peptides was retained for proteome analysis. TiO<sub>2</sub> spin tip was first  
288 washed with 80 % ACN, 6% TFA and then with 50% ACN, 0.1% TFA at 200 × g.  
289 Phosphopeptides were eluted from TiO<sub>2</sub> beads by transfer to into a new microcentrifuge tube  
290 containing 20% FA, using 10 % NH<sub>4</sub>OH solution via centrifugation at 100 × g. To prevent the  
291 loss of phosphopeptides retained by the C8 plug a second elution was carried out with 80%  
292 ACN, 2% FA via centrifugation at 100 × g. Eluate fractions were combined and lyophilized  
293 prior to mass spectrometry analysis.

294

295 Mass spectrometry analysis

296 Peptides were analyzed on a Q-Exactive HF instrument (Thermo Scientific) coupled with an  
297 EASY nLC 1200 chromatography system (Thermo Scientific). Samples were loaded at 900  
298 bars on an in-house packed 50 cm nano-HPLC column (75  $\mu\text{m}$  inner diameter) with C18 resin  
299 (3  $\mu\text{m}$  particles, 100  $\text{\AA}$  pore size, Reprosil-Pur Basic C18-HD resin) and equilibrated in 98 %  
300 solvent A ( $\text{H}_2\text{O}$ , 0.1 % formic acid) and 2 % solvent B (acetonitrile, 0.1 % formic acid). For  
301 both proteome and phosphoproteome analysis, peptides were eluted using a 3 to 29 % gradient  
302 of solvent B during 105 min, then a 29 to 56 % gradient of solvent B during 20 min and finally  
303 a 56 to 90 % gradient of solvent B during 5 min all at 250 nl/minute flow rate. The instrument  
304 method for the Q-Exactive HF was set up in the data dependent acquisition mode. After a survey  
305 scan in the Orbitrap (resolution 60,000), the 12 most intense precursor ions were selected for  
306 higher-energy collisional dissociation (HCD) fragmentation with a normalized collision energy  
307 set up to 26. Precursors were selected with a window of 2.0 Th. MS/MS spectra were recorded  
308 with a resolution of 15,000. Charge state screening was enabled, and precursors with unknown  
309 charge state or a charge state of 1 and  $>7$  were excluded. Dynamic exclusion was enabled for  
310 30 sec. For phosphoproteomic analysis, technical replicates were carried out in which samples  
311 acquisition was repeated twice for each label swap replicate.

312

313 Mass spectrometry data processing

314 All raw data were searched using MaxQuant software version 1.6.1.0 (Cox and Mann, 2008;  
315 Tyanova et al., 2016), which incorporates the Andromeda search engine (Cox et al. 2011),  
316 against the *Trypanosoma brucei* 927 genome downloaded from TritypDB  
317 (<http://www.tritypdb.org/>) (Version 37, 11,074 protein sequences) (Amos et al. 2022)  
318 supplemented with frequently observed contaminants (such as mammalian keratins, porcine  
319 trypsin and bovine serum albumins). All SILAC features were selected by default using the  
320 appropriate heavy K and R amino acid to be detected. Modifications included  
321 carbamidomethylation (Cys, fixed), oxidation (Met, variable) and N-terminal acetylation  
322 (variable) and phosphorylation (S, T, Y variable). The mass tolerance was set to 6 parts per  
323 million (ppm) and peptides were required to be minimum 7 amino acids in length. Matching  
324 between runs allows peptides that are present in one sample but not identified by MS/MS in all  
325 samples to be identified by similarities in retention times and mass. The false discovery rates  
326 (FDRs) of 0.01 was calculated from the number of hits against a reversed sequence database.  
327 Only phosphorylation sites with a MaxQuant localisation probability  $> 0.95$  were considered.

328

329 Statistical analysis of proteomic data

330 Statistical analysis was carried out using Persues (Tyanova et al. 2016) version 1.6.1.3. SILAC  
331 ratios were transformed to Log<sub>2</sub> and intensities to Log<sub>10</sub>. Values were subject to further quality  
332 filtering such that ratios with >100% variation between label swap replicates were removed,  
333 and the localization probability of each phosphorylation site was required to be  $\geq 0.95$ .  
334 Significantly changing phosphorylation sites were identified using Significance B testing (Cox  
335 and Mann 2008) which takes into account the intensity-weighted significance and used a  
336 Benjamini-Hochberg correction (Benjamini and Hochberg 1995) to set the false discovery rate  
337 at  $\leq 0.01$ . Categorical enrichment was calculated using a Fischer's exact test with a false  
338 discovery rate (FDR)  $\leq 0.01$ . Gene Ontology (GO) term enrichment was carried out on the  
339 significantly enriched phosphosites for the <sup>1</sup>HR and VSG<sup>up</sup> data sets, using a Fischer's exact  
340 test (FDR  $\leq 0.05$ ). All other statistical analysis was carried out in Microsoft Excel and GraphPad  
341 Prism, version 9.

342

## 343 Results

344

### 345 Adaptation of the <sup>1</sup>HR and VSG<sup>up</sup> cell lines to SILAC medium

346 In order to study the cellular response to locus specific DSBs, we used two established cell  
347 lines, <sup>1</sup>HR and VSG<sup>up</sup>, that contain the tetracycline inducible yeast I-*SceI* homing endonuclease  
348 which induces a DSB in approximately 95 % of all cells (Glover, McCulloch, and Horn 2008;  
349 Glover, Alford, and Horn 2013). The <sup>1</sup>HR cell line contains an 18 bp I-*SceI* heterologous  
350 recognition sequence (*SceR*; Figure 1A) at an intergenic chromosome internal polycistronic  
351 transcription unit on one homolog of chromosome 11 (Glover, McCulloch, and Horn 2008)  
352 (Figure 1A), and the VSG<sup>up</sup> strain harbours the *SceI* upstream of the actively expressed VSG-2  
353 on chromosome 6a (Figure 1B)(Boothroyd et al. 2009; Glover, Alford, and Horn 2013). We  
354 then set out to characterise changes in the phosphoproteome in response to DSBs induced at (i)  
355 chromosome internal locus (<sup>1</sup>HR cell line) and (ii) within the active BES (VSG<sup>up</sup> cell line).

356 SILAC experiments require the metabolic incorporation of stable isotope labelled amino  
357 acids present in the cell culture medium. Trypanosomatids are auxotrophic for arginine (R) and  
358 lysine (K) (Marchese et al. 2018) and we therefore used cell culture medium lacking in both  
359 and supplemented with either the 'heavy' isotope labelled L-Arginine U-<sup>13</sup>C<sub>6</sub> and L-Lysine  
360 4,4,5,5-<sup>2</sup>H<sub>4</sub> (R<sub>6</sub>K<sub>4</sub>), or 'light' labelled L-Arginine and L-Lysine (R<sub>0</sub>K<sub>0</sub>). Trypanosome parasites  
361 have been shown to grow normally in SILAC HMI-9 and remain infective in mice (Urbaniak,  
362 Martin, and Ferguson 2013). Incorporation of labelled amino acids in the <sup>1</sup>HR and VSG<sup>up</sup> cell

363 lines was assessed by mass spectrometry (MS), and we observed 93.4% and 96.1% heavy label  
364 incorporation in the <sup>1</sup>HR and VSG<sup>up</sup> cell lines, respectively (Figure S1A). In both the <sup>1</sup>HR and  
365 VSG<sup>up</sup> cell lines,  $\gamma$ H2A foci form post DSB induction (Glover and Horn 2012; Glover, Alford,  
366 and Horn 2013), we observed  $\gamma$ H2A foci formation in cells grown in SILAC medium (Figure  
367 S1B), indicating a robust DNA damage response.

368

### 369 **Analysis of the total proteome following a double strand break**

370 In bloodstream form trypanosomes,  $\gamma$ H2A accumulation peaks at 12 h post DSB induction  
371 in both the <sup>1</sup>HR and VSG<sup>up</sup> cell lines (Glover and Horn 2012), and ssDNA accumulates  
372 between 9-12 h (Glover, McCulloch, and Horn 2008; Glover, Alford, and Horn 2013). We  
373 therefore chose to carry out proteomic analysis at 12 h post DSB induction. For each sample,  
374 a label swap replicate was carried out (induced cells grown in ‘light’ media and uninduced in  
375 ‘heavy’ media). Analysis of the total peptide extract was carried out and in the <sup>1</sup>HR data set, a  
376 total 2,457 proteins were identified (Figure 1C), and only 12 of these showed a > 2-fold change  
377 in abundance following DSB induction. In the VSG<sup>up</sup> proteome, a total of 2,646 proteins were  
378 identified (Figure 1D) only 8 of which had a > 2-fold change in abundance following DSB  
379 induction. This confirms that large changes at the protein level are not seen at 12 h post DSB  
380 induction. However, we did observe a notable down-regulation of the ribosomal proteins in  
381 both the <sup>1</sup>HR and VSG<sup>up</sup> proteomes (Figures 1C and D). Ribosomal proteins are important for  
382 the assembly of ribosomal subunits and also function as RNA chaperones (X. Xu, Xiong, and  
383 Sun 2016). The specific down regulation of ribosomal genes observed here suggests that there  
384 may be a global inhibition of protein translation in response to DNA damage as has been  
385 reported following a CRISPR-Cas9 induced DSB in mammalian cells (Riepe et al. 2021).

386

### 387 **The DSB locus-specific phosphoproteome of the <sup>1</sup>HR and VSG<sup>up</sup> strains.**

388 Within the total protein extract, phosphorylated peptides are of low abundance, and so  
389 we carried out an enrichment step using affinity purification on a TiO<sub>2</sub> column (Rappsilber,  
390 Mann, and Ishihama 2007). In total, we identified 6,905 phosphorylation sites in the <sup>1</sup>HR  
391 phosphoproteome (Figure 2A) and 6,540 for VSG<sup>up</sup> (Figure 2B). Of these sites, 5,991 were  
392 common to both the <sup>1</sup>HR and VSG<sup>up</sup> data sets, and 914 and 549 sites were unique to the <sup>1</sup>HR  
393 and VSG<sup>up</sup> respectively (Figure 2C). Using  $\gamma$ H2A as a positive control for the phosphoproteome  
394 analysis, in the <sup>1</sup>HR strain we report an average of 5.39 fold increase in  $\gamma$ H2A T131 (previously  
395 annotated as T130 excluding the initiator methionine (Glover and Horn 2012) (Figure 2A) and

396 a 1.97 fold increase in the VSG<sup>up</sup> strain (Figure 2B), confirming that we are able to detect DSB  
397 specific phosphorylation events using quantitative phosphoproteomics.

398 To identify significantly changing phosphorylation sites in the two data sets, we used  
399 Significance B testing (Cox and Mann 2008), which takes into account the intensity-weighted  
400 significance. Overall, there was no significant change in the distribution of phosphorylation  
401 events amongst phospho serine and thereonine, but our data set included no phosphorylation of  
402 tyrosine (Figure S2A) compared to published data. The majority of the phosphorylation events  
403 identified were on known proteins (Figure S2B). We identified 128 significantly altered  
404 phosphosites on 81 proteins in the <sup>1</sup>HR phosphoproteome, 107 of which were upregulated and  
405 22 downregulated (Figure 2A, Supplementary dataset 2). In the VSG<sup>up</sup> phosphoproteome 135  
406 significantly altered sites were identified on 95 proteins, 65 of which were upregulated and 70  
407 down regulated (Figure 2B, Supplementary dataset 2). Within the phosphoproteomes, 26 sites  
408 were significantly enriched in both the <sup>1</sup>HR and VSG<sup>up</sup> strains. Of these 26 phosphorylation  
409 sites, 21 were upregulated in the <sup>1</sup>HR, and only 3 were upregulated in VSG<sup>up</sup>, with down  
410 regulation of phosphorylation making a bigger contribution to subtelomeric DSB. Amongst  
411 the 26 phosphosites that were significantly enriched in both the <sup>1</sup>HR and VSG<sup>up</sup> datasets, a  
412 number of modifications on proteins involved in RNA binding, RNA processing and translation  
413 were identified (Data set 1). We surveyed the 211 DSB responsive phosphorylation sites for  
414 categorical enrichment of Gene Ontology (GO) terms, using a Fischer's exact test ( $FDR \leq 0.05$ ).  
415 The significantly enriched <sup>1</sup>HR and VSG<sup>up</sup> phosphorylation sites were further divided into  
416 phosphoproteins that were significantly upregulated or down regulated in each data set. In <sup>1</sup>HR  
417 6 significantly enriched GO terms were identified for upregulated phosphosites, which included  
418 histones and proteins that response to DNA damage (Figure S3A(i)), and one for VSG<sup>up</sup> (Figure  
419 S3A(ii)). The reverse was seen with downregulated phosphosites; RNA binding was common  
420 to both, and 5 terms were enriched in the VSG<sup>up</sup> including chromatin organisation (Figure S3B  
421 (ii)) and one for <sup>1</sup>HR, RNA processing (Figure S3B (i)).

422 We next identified modifications on selected DNA repair proteins (Figure 3A). The  
423 H2A phosphorylation on a conserved S/T-Q motif (Redon et al. 2002; Rogakou et al. 1998) to  
424 give  $\gamma$ H2AX, or  $\gamma$ H2A in trypanosomes, is a widely studied early marker of DNA damage  
425 (Foster and Downs 2005; Glover and Horn 2012). We observe robust phosphorylation of *T.*  
426 *brucei*  $\gamma$ H2A (T131) in response to a DSB (Figure 2A and B) and identified two additional  
427 modifications on the H2A C-terminus: S113 and S133 (Figure 3A), with only T131 and S133  
428 being conserved amongst trypanosomatids (Figure 3B). Phosphorylation of S133 increased by  
429 5.39-fold ( $p = 2.0283 \times 10^{-6}$ ) in the <sup>1</sup>HR strain and 1.97-fold ( $p = 1.3392 \times 10^{-3}$ ) in the VSG<sup>up</sup>

430 strain (Data set 1). Individual phosphorylation events were detected on fragments harbouring  
431 exclusively T131 or S133, confirming that both sites are phosphorylated (Figure 3B). The third  
432 phosphorylation site identified on the H2A tail, S113, was 3.16-fold ( $p=0.000432$ ) upregulated  
433 in response to an  $^1\text{HR}$  DSB and is conserved in *T. cruzi* but not *Leishmania* (Figure 3B)  
434 indicating that there are lineage specific modifications to the histone tail. In mammals,  
435 phosphorylation of the H2B C-terminus is a late marker of DNA damage, dependent on  $\gamma\text{H2AX}$   
436 (Fernandez-Capetillo, Allis, and Nussenzweig 2004). We detected a novel phosphorylation site  
437 at S39 on the C terminus of H2B (Tb927.10.10590) in  $^1\text{HR}$  strain (1.89-fold increase,  
438  $p=0.0339$ ), and in  $\text{VSG}^{\text{up}}$  (1.25-fold increase,  $p = 0.38$ ) (Figure 3A). It is possible that H2B C-  
439 terminal phosphorylation will increase overtime until repair is complete. In mammalian cells  
440 3 members of the NIMA (never in mitosis gene a)-related (NEK) kinase family, NEK1, NEK1,  
441 NEK10 and NEK11 are involved in the DDR and are implicated in check point control  
442 following DNA damage (Chen et al. 2011). We saw a significant enrichment of the  
443 phosphorylation of the serine/ threonine protein kinase NEK17 (Tb927.10.5950) in response to  
444 an  $^1\text{HR}$  DSB with two sites on NEK17, S197 and T195, increase by 6.14-fold ( $p = 6.13622 \times$   
445  $10^{-8}$ ) (Data set 1). NEK17 kinase is therefore a possible candidate for implementing  
446 phosphorylation marks that are specific to  $^1\text{HR}$  DSB.

447 The heterotrimeric RPA complex, consisting of RPA-1, RPA-2 and RPA-3, is the major  
448 ssDNA binding protein in eukaryotes, and a number of phosphorylation sites of interest were  
449 identified on the complex in our data (Supplementary dataset 1). In mammals and yeast, the N-  
450 terminus of RPA-2 is hyper phosphorylated by ATR in response to a DSB (Maréchal and Zou  
451 2015; Vassin et al. 2009). This hyperphosphorylation increases the affinity of RPA-2 for  
452 RAD51 (Wu et al. 2005) and promotes repair by HR (Shi et al. 2010). We identified only one  
453 phosphorylation site on RPA-2, S4, which showed a moderate up regulation of 1.45 and 1.82-  
454 fold in response to  $^1\text{HR}$  and  $\text{VSG}^{\text{up}}$  DSBs, respectively, suggesting that the N-terminus of RPA-  
455 2 is not hyperphosphorylated at 12 h post DSB induction (Figure 4A). Two sites on RPA-1  
456 (Tb927.11.9130), the single stranded DNA binding component of the complex (Byrne and  
457 Oakley 2019), had specific sites phosphorylated. The first site, S5 was previously identified in  
458 a global phosphoproteomics analysis (Urbaniak, Martin, and Ferguson 2013) and we reported  
459 an average fold change in phosphorylation of 2.77 ( $p = 0.001$ ) and 1.31 ( $p = 0.29$ )  
460 (Supplementary dataset 1) in response to DSBs induced in the  $^1\text{HR}$  and  $\text{VSG}^{\text{up}}$  cell lines,  
461 respectively (Figure 3A). The second site, S43 showed a 6.1-fold increase ( $p = 9.69 \times 10^{-9}$ ) in  
462 response to an  $^1\text{HR}$  DSB (Figure 3A), and 1.7-fold increase ( $p = 0.06$ ) in the  $\text{VSG}^{\text{up}}$   
463 phosphoproteome (Supplementary dataset 1). Functional analysis of the *T. brucei* RPA-1

464 homolog (Tb927.11.9130) using InterPro (Blum et al. 2020) predicts 3 DNA binding OB fold  
465 domains (Figure S4A), similar to *L. amazonensis* RPA-1 (Pavani et al. 2014; Da Silveira et al.  
466 2013) and *T. cruzi* RPA-1 (Pavani et al. 2016). The RPA-1 S43 modification lies in the first OB  
467 fold domain, whilst S5 lies outside of the OB fold domains (Figure S4A). In order to determine  
468 whether the phosphorylation sites identified are conserved amongst trypanosomatids and other  
469 eukaryotes we aligned the RPA-1 sequence of trypanosomatids, *Homo sapiens* and  
470 *Saccharomyces cerevisiae* (Figure 1D). Multiple sequence alignment demonstrates that RPA-1  
471 S5 lies in a trypanosomatid specific flexible linker, and the residue is conserved with *T. cruzi*  
472 but not *T. vivax* or *L. braziliensis*. The second phosphorylation site, RPA-1 S43, is conserved  
473 amongst *T. cruzi*, *T. vivax* and *L. braziliensis*, however not with *H. sapiens* or *S. cerevisiae*  
474 RPA-1 (Figure 4A). In *H. sapiens* the adjacent position, R42, has been identified as a key  
475 residue involved in interacting with DNA phosphates (Bochkarev et al. 1997).

476

#### 477 **The <sup>1</sup>HR RPA-1<sup>S5A</sup> mutant has increased $\gamma$ H2A signalling and a resection defect following** 478 **a DSB**

479 RPA-1 phosphorylation mediates ssDNA interactions in yeast (Yates et al. 2018), we  
480 therefore asked whether mutation of the phosphorylation sites identified in our  
481 phosphoproteomic data set led to a disruption of repair of a chromosome internal DSB (Glover,  
482 McCulloch, and Horn 2008). To determine the role of the phosphorylation of S43 we mutated  
483 this site to an alanine, which does not contain a hydroxyl functional group and therefore cannot  
484 be phosphorylated, in the <sup>1</sup>HR cell line (Figure S4B). The replacement was confirmed by PCR  
485 in a pair of clones (Figure S4C and D). The resulting cell line is referred to as <sup>1</sup>HR RPA-1<sup>S5A</sup>.  
486 Repeated attempts were made to mutate the S43 site, but no viable clones could be recovered  
487 even from a single allele replacement. This suggests that RPA-1 pS43 is essential for parasite  
488 growth and that disruption of the phosphorylation site is deleterious to parasite growth.

489 We observed a slight reduction in <sup>1</sup>HR RPA-1<sup>S5A</sup> cell growth over 96 h when compared to  
490 the parental <sup>1</sup>HR strain, but growth was not significantly compromised (Figure S4E). In  
491 trypanosomes DNA damage can be monitored by both  $\gamma$ H2A and RAD51 foci formation  
492 (Glover and Horn 2012). In the <sup>1</sup>HR cell line  $\gamma$ H2A foci were observed in 19.4% of uninduced  
493 cells had and this increased to 58.4% at 12 h post DSB induction, (Figure 4B) in agreement  
494 with previous findings (Glover and Horn 2012; 2014b; Mehnert et al. 2021). For the <sup>1</sup>HR RPA-  
495 1<sup>S5A</sup> mutants  $\gamma$ H2A foci in uninduced cells were slightly increased at 24.5% and this rose to  
496 72.4% following DSB induction, significantly higher than the induced <sup>1</sup>HR strain (p = 0.0261)  
497 (Figure 4B) possibly reflecting unrepaired DNA lesions. We then looked at RAD51 foci



498 formation in the <sup>1</sup>HR cell line, foci were seen in 1.4% of uninduced cells, and this increased to  
499 43.7% 12 h post DSB induction, consistent with previous reports (Glover, McCulloch, and Horn  
500 2008; Mehnert et al. 2021). In the <sup>1</sup>HR RPA-1<sup>S5A</sup> cell line RAD51 foci were seen in 2.7% of  
501 cells and this increased to 32.9% at 12 h post DSB induction, less than seen for the <sup>1</sup>HR cell  
502 line following a DSB (Figure 4C).

503 Repair of a DSB begins with 5' to 3' DNA resection either side of the break, catalysed by  
504 the MRE11 exonuclease, and the ssDNA overhangs serve as substrates for RAD51 filament  
505 formation and provides a template for HR (Syed and Tainer 2018). Given that  $\gamma$ H2A signalling  
506 increased following a DSB in the <sup>1</sup>HR RPA-1<sup>S5A</sup> cell line, we asked whether the formation of  
507 ssDNA either side of the *I-SceI* cleavage site is compromised by the RPA-1<sup>S5A</sup> mutation. Using  
508 a quantitative resection assay (Mehnert et al. 2021) we found that ssDNA increased over 0 to  
509 12 h post DSB induction with a relative percentage of 1.7%, 30.5, 75.0 % at 0 h, 6 h and 12 h,  
510 respectively (Figure 4D). The accumulation of ssDNA in <sup>1</sup>HR cell line strain therefore follows  
511 a pattern similar to that observed previously using quantitative PCR (Mehnert et al. 2021) and  
512 slot blots (Glover, McCulloch, and Horn 2008; Glover and Horn 2014b). In the <sup>1</sup>HR RPA-1<sup>S5A</sup>  
513 cell line, the amount of ssDNA increased from 2.4% at 0 h to 49.8% at 6 h, and then to 87.7%  
514 at 12 h. The amount of ssDNA detected at all time points was increased in the mutant cell line,  
515 and this increase was significantly higher at 6 h post DSB induction ( $p = 0.002$ )(Figure 4D).  
516 This suggests that RPA-1<sup>S5P</sup> restricts ssDNA resection at a chromosome internal site.

517 To determine if repair pathway choice was affected in the <sup>1</sup>HR RPA-1<sup>S5A</sup> cell line we  
518 generated a panel of subclones by clonogenic assays that were either uninduced ( $n = 5$ ) or grown  
519 under DSB inducing condition ( $n = 11$ ). The *I-SceI* recognition site lies on an *RFP:PAC* fusion  
520 cassette (Figure 1A) in the <sup>1</sup>HR cell line. Repair by homologous recombination will result in  
521 the loss of the fusion cassette, while repair by microhomology mediated end joining will result  
522 in retention of the fusion cassette but will result in a deletion mutation. Out of 11 induced  
523 subclones, only subclone was *RFP-PAC* positive, indicating that repair by HR predominates in  
524 the S5 mutant cell line (Figure 4D and Figure S5A). Sequencing of the region accommodating  
525 the *RFP-PAC* cassette was carried out for the one positive subclone, revealing an 81 bp deletion  
526 and therefore repair by MMEJ using short regions of homology.

527

## 528 **Mutation of S5 in RPA-1 leads to a resection defect following a subtelomeric DNA break**

529 Our phosphoproteomic screens identified that RPA-1 S5 is phosphorylated in response  
530 to both chromosome internal (<sup>1</sup>HR) and telomeric (VSG<sup>up</sup>) DSBs (Figure 3A). To investigate  
531 repair at a subtelomeric region, we replaced both *RPA-1* alleles with a mutated *RPA-1*<sup>S5A</sup> as was

532 described for the <sup>1</sup>HR RPA-1<sup>S5A</sup> cell line (Figure S6A and B). The replacement of both *RPA-1*  
533 alleles was confirmed by PCR (Figure S6A and B) and sequencing of the PCR product was  
534 used to confirm the S5A mutation. As in the <sup>1</sup>HR RPA-1<sup>S5A</sup> cell line, VSG<sup>up</sup>RPA-1<sup>S5A</sup> showed  
535 only a slight reduction in cell growth in both uninduced and DSB inducing conditions over 96  
536 h (Figure S6C), indicating that RPA-1 pS5 is not essential for the repair of a telomeric DSB.  
537 We next looked at the accumulation of  $\gamma$ H2A. In the VSG<sup>up</sup> cell line  $\gamma$ H2A foci were observed  
538 in 19.9% of uninduced cells and this increased to 45.4% at 12 h post DSB induction (Figure  
539 5A), consistent with previous findings (Glover, Alford, and Horn 2013; Glover and Horn  
540 2014b; Mehnert et al. 2021). For the VSG<sup>up</sup>RPA-1<sup>S5A</sup> mutant, the number of foci rose from  
541 25% to 46.6% at 12 h post DSB induction (Figure 5A), showing no significant difference from  
542 the parental cell line. This suggests that the RPA-1<sup>S5A</sup> mutation has a larger impact on DSB  
543 repair at a chromosome internal site compared to at telomeric location. We did not assess  
544 RAD51 foci formation in the VSG<sup>up</sup> mutants as RAD51 foci are not observed in response to  
545 telomeric DSBs (Glover, Alford, and Horn 2013).

546 We then assessed ssDNA accumulation in response to a subtelomeric DSB. Using our  
547 quantitative PCR assay (Mehnert et al. 2021) we determined that in the VSG<sup>up</sup> cell line ssDNA  
548 accumulated over 12 h post DSB induction with a relative abundance of ssDNA of 1.2% at 0 h  
549 increasing to 5.5 % at 6 h and 10.6% at 12 h (Figure 5C) a pattern similar to that previously  
550 seen (Mehnert et al. 2021). In the VSG<sup>up</sup>RPA-1<sup>S5A</sup> mutants, the relative amount of ssDNA was  
551 3.3% at 0 h, and then decreased to 1.9% at 6 h, significantly lower than the same time point in  
552 the VSG<sup>up</sup> cell line ( $p = 0.0007$ ) and 15.3% at 12 h post DSB induction. The RPA-1<sup>S5A</sup> mutation  
553 therefore disrupts ssDNA formation in response to a subtelomeric DSB with the initial stages  
554 of ssDNA resection inhibited by the mutation. This is in direct contrast to repair at a  
555 chromosome internal site, where the mutation leads to an increase in ssDNA resection. Given  
556 that the timing of ssDNA formation was disrupted in the VSG<sup>up</sup>RPA-1<sup>S5A</sup> cell line, we were  
557 interested in whether VSG switching is disrupted following a DSB. Prior to DSB induction,  
558 100% of the VSG<sup>up</sup> population was VSG-2 positive by IFA, as expected (Figure S6D).  
559 Following a DSB in the VSG<sup>up</sup> cell line, VSG-2 was detected in 6.7% of the population. The  
560 remaining 94.3% had replaced VSG-2, which we will refer to here as ‘VSG-X’. In the  
561 VSG<sup>up</sup>RPA-1<sup>S5A</sup> mutants VSG-2 was also observed at the surface of all uninduced cells and  
562 this was reduced to 7.3% of the population upon DSB induction, with 92.3% of the population  
563 had switched to VSG-X (Figure S6D) suggesting VSG switching unaffected in the RPA-1<sup>S5A</sup>  
564 mutants.

565 To investigate how repair comes about in the RPA-1 mutants, we used a series of  
566 established repair assays (Glover, Alford, and Horn 2013; Mehnert et al. 2021) to map  
567 individual repair events in a panel of induced and uninduced subclones generated for the VSG<sup>up</sup>  
568 and VSG<sup>up</sup>RPA-1<sup>S5A</sup> cell lines. BES1 contains 2 blocks of 70 bp repeats, the first block is  
569 located immediately upstream of the *VSG* and a second smaller 70 bp repeat region is found  
570 further upstream, flanked by *pseudo* gene and *ESAG1* (Figure 5C). The presence or absence of  
571 *VSG-2*, *ESAG1* and *pseudo* can be used to determine how repair has come about in induced  
572 subclones (Glover, Alford, and Horn 2013). Repaired clones that retained *ESAG1* and *pseudo*  
573 but have lost *VSG-2* are expected to have undergone GC using the 70 bp repeats upstream of  
574 *VSG-2* as a homologous template. All uninduced subclones (n = 5 for both cell lines) were *VSG-*  
575 *2*, *ESAG1* and *pseudo* positive, as expected and *VSG-2* was lost in both VSG<sup>up</sup> and VSG<sup>up</sup>RPA-  
576 1<sup>S5A</sup> subclones (Figure 5C and S5A and B). All VSG<sup>up</sup> induced subclones (n=20) and 20 out  
577 of 22 VSG<sup>up</sup>RPA-1<sup>S5A</sup> had lost *VSG-2* (Figure 5C and S5A and B). The two *VSG-2* positive  
578 VSG<sup>up</sup>RPA-1<sup>S5A</sup> clones were puromycin sensitive, indicating cleavage by I-*SceI*, and have  
579 likely undergone repair by MMEJ. *ESAG1* and *pseudo* were retained in 75% of induced VSG<sup>up</sup>  
580 subclones (Figure 5C), consistent with previous findings that GC using the large block of 70  
581 bp repeats predominates in this cell line (Glover, Alford, and Horn 2013), and 82% of  
582 VSG<sup>up</sup>RPA-1<sup>S5A</sup> subclones (Figure S7B). Overall, we did not observe a considerable difference  
583 between repair at the BES in the parental and mutant cell line.

584

### 585 **The RPA-1<sup>S5A</sup> mutation does not disrupt access to the *VSG* repertoire**

586 The *T. brucei* genome contains over 2500 *VSG* genes and *pseudo* genes in subtelomeric  
587 arrays (Berriman et al. 2005; Cross, Kim, and Wickstead 2014), which can be used as templates  
588 for recombination during antigenic variation. The order in which these archival *VSGs* are  
589 activated is thought to be a semi-ordered process during an infection, with BES associated *VSGs*  
590 being most frequently activated followed by *VSGs* found in the subtelomeric arrays and finally  
591 *pseudo* genes (Morrison et al. 2005; Marcello and Barry 2007; Stockdale et al. 2008). We  
592 therefore assessed whether the RPA-1<sup>S5A</sup> mutation disrupted access to the antigen repertoire  
593 during a *VSG* switch. To do this we used *VSG*-seq (Mugnier, Cross, and Papavasiliou 2015),  
594 which makes use of conserved sequences in the 5' SL and 3' UTR of every *VSG* mRNA to  
595 amplify and subsequently sequence of all of the *VSGs* expressed in a population. The expressed  
596 *VSGs* in the VSG<sup>up</sup> and VSG<sup>up</sup>RPA-1<sup>S5A</sup> cell lines were amplified and sequenced 0- and 7-days  
597 post DSB induction. *VSG* genes were considered significantly enriched when the log<sub>2</sub> fold  
598 change (FC) of the induced (+ Tet) sample compared to the uninduced (- Tet) is > 2, with a p

599 <0.05. We identified 136 VSG sequences that were significantly enriched in the VSG<sup>up</sup> cell line  
600 (Figure 10A) and 128 were enriched in the VSG<sup>up</sup>RPA-1<sup>S5A</sup> cell line (Figure 5D). We next  
601 looked at the genomic locations of the significantly enriched genes by mapping them to the *T.*  
602 *brucei* 427 genome (Müller et al. 2018) (Figure 5E). In the VSG<sup>up</sup> cell line 10 BES VSGs and  
603 27 VSGs located on the minichromosomes were enriched. In the VSG<sup>up</sup>RPA-1<sup>S5A</sup> cell line, 9  
604 BES VSGs were enriched and 25 minichromosomal VSGs (Figure 5E). Therefore, the RPA-  
605 1<sup>S5A</sup> mutant does not significantly alter the number and genomic positions of the templates used  
606 to repair a BES DSB, with both cell lines using a similar number and variety of templates for  
607 DSBR

608

## 609 Discussion

610 Here we report the use of SILAC quantitative phosphoproteomics to characterise the *T.*  
611 *brucei* DSB phosphoproteome in response DSBs targeted at both chromosome internal and  
612 subtelomeric loci. While the purpose of this study was to determine the specific  
613 phosphorylation events that govern the DDR in *T. brucei*, analysis of the proteome revealed  
614 that ribosomal proteins are down regulated following a DNA break. A similar phenomenon is  
615 seen in human cells where phosphorylation of eIF2a halts translation following a DSBs via  
616 ribosome remodelling (Riepe et al. 2021), whilst mouse embryonic fibroblasts exposed to  
617 global DNA damage results in transcriptional silencing in the nucleolus (Kruhlak et al. 2007).  
618 The down regulation of ribosomal proteins identified here alludes to cross talk between the  
619 nucleolus and the DDR, as has been observed in other organisms (Ogawa and Baserga 2017).

620 Our DNA damage phosphoproteome implicated RNA binding proteins (RBP) in DSBR.  
621 Phosphoproteomic studies of the DNA damage response in human cells have also identified  
622 enrichment of proteins with RNA binding capacity (Matsuoka et al. 2007; Bennetzen et al.  
623 2010) and a number of RBPs have been shown to have a dual role in both RNA binding and  
624 the DDR. Such is the emerging evidence for the roles of RBPs in the DDR that a new class of  
625 proteins has been defined, the DNA damage response RNA binding proteins (DDRBP)  
626 (Dutertre and Vagner 2017). Some of these DDRBPs can also bind double or ssDNA and are  
627 involved in regulating R-loop formation (Aguilera and Garcia-Muse 2012; Dutertre and Vagner  
628 2017) by coating the nascent RNA (Nishida et al. 2017; Sollier et al. 2014). R-loop formation  
629 is associated with increased DNA damage and VSG switching in *T. brucei* (Briggs et al. 2018)  
630 and it is possible that some of the RBPs identified here suppress R-loop formation following  
631 DSB induction. However, it is of note that in yeast R-loop formation is an important part of

632 efficient HR (Keskin et al. 2014; Ohle et al. 2016), and it is also possible that RBPs assist in  
633 productive R-loop formation that contributes to DSBR.

634 The phosphorylation status of a given protein is a dynamic equilibrium balanced by the  
635 actions of protein kinases and protein phosphatases. In human cells, phosphoproteomic analysis  
636 of the DSBR revealed that approximately one third of the total sites identified are  
637 dephosphorylated in response to a DSB (Bennetzen et al. 2010; Bensimon et al. 2010), and here  
638 dephosphorylation was highly represented in VSG<sup>up</sup>, accounting for 51% of significantly  
639 altered modifications, indicating its important role at the subtelomeric locus. In contrast, the  
640 majority of significantly altered phosphorylation sites following an <sup>1</sup>HR are upregulated, again  
641 highlighting the disparity between chromosome internal and subtelomeric repair. Histone  
642 modifications play a key role in the DNA damage response (DDR), regulating access to  
643 chromatin and signalling for DNA damage (Van and Santos 2018). Key to the DDR is the  
644 phosphorylation of histone H2A at T131 to give  $\gamma$ H2AX in trypanosomes. In mammals, the  
645  $\gamma$ H2AX modification occurs at S139, however T136 and other phosphorylation sites on the  
646 histone tail have also been shown to be involved in the mammalian response to DNA damage  
647 (Redon et al. 2002; Xie et al. 2010). In *S. cerevisiae*, systematic mutation of the histone tail  
648 identified three sites on the H2A tail that are important for DNA damage, all of which are  
649 involved in DSBR by HR (Moore et al. 2007). In our phosphoproteome we identified two  
650 additional sites in histone H2A that are phosphorylated in response to a DNA break: S113 and  
651 S133. Given that these modifications were not previously annotated in global analysis of the *T.*  
652 *brucei* phosphoproteome (Benz and Urbaniak 2019; Urbaniak, Martin, and Ferguson 2013)  
653 they are likely highly specific to DSBR. We suggest that as the T131 lies four residues from  
654 the C terminus of H2A, it is the analogous modification to that seen in both mammalian and  
655 yeast DDR, however whether there is interdependency between the two sites requires further  
656 investigation.

657 One of the greatest up regulated phosphorylation sites following a <sup>1</sup>HR DSB was the  
658 modification of RPA-1 S43, which increased by an average of 6.1-fold, suggesting that the  
659 protein is abundantly and specifically phosphorylated in response to a break. The RPA-1 S43  
660 phosphorylation site identified here was not previously identified in a global study of the *T.*  
661 *brucei* phosphoproteome (Urbaniak, Martin, and Ferguson 2013) indicating that the  
662 modification is DNA damage specific. We were unable to generate homozygous RPA-1<sup>S43A</sup>  
663 mutants despite repeated attempts and we speculate that that prohibiting the phosphorylation of  
664 RPA-1 S43 is lethal to the cell. RPA-1 S43 lies within the conserved DNA binding domain  
665 OB1, which has the highest affinity for ssDNA in trypanosomes (Neto et al. 2007; Pavani et al.

666 2016; Pavani et al. 2014) and is conserved amongst trypanosome species. The adjacent residue  
667 in *H. sapiens* RPA-1 has been shown to directly interact with DNA phosphates (Bochkarev et  
668 al. 1997) and it is therefore possible that disruption of the neighbouring residue in  
669 trypanosomatid RPA-1 destabilises the interaction with ssDNA. Given the diverse functions of  
670 the RPA complex in the cell (Byrne and Oakley 2019), the introduction of a mutation that  
671 disrupts ssDNA binding would likely be highly damaging to the cell.

672 The second phosphorylation site identified on RPA-1, S5, showed a moderate increase  
673 in phosphorylation compared to that of S43. RPA-1 S5 mutants showed an increase in  $\gamma$ H2A  
674 foci formation and ssDNA at a chromosomal internal break, suggesting prolonged unrepaired  
675 damage, interestingly this increase was not reciprocated following a break at the active  
676 expression site. A greater increase in phosphorylation was identified following an <sup>1</sup>HR DSB  
677 compared to a VSG<sup>up</sup> DSB (2.7 FC in phosphorylation and 1.7 FC, respectively) which may be  
678 related to the strong preference for HR at this site (Glover, McCulloch, and Horn 2008), which  
679 involves the generation of long stretches of ssDNA either side of the DSB that are stabilised by  
680 the binding of the RPA complex. The RPA-1 S5 mutation had contrasting effects on ssDNA  
681 accumulation at a subtelomeric locus, here ssDNA accumulation severely reduced in the first 6  
682 h following a break, indicating that the initial stages of resection are inhibited. DNA resection  
683 at the BES has previously been shown to be associated with the histone acetyl transferase HAT3  
684 and TbmRE11, which suppresses subtelomeric ssDNA formation (Glover and Horn 2014;  
685 Mehnert et al. 2021). Interestingly, despite the disruption in ssDNA accumulation at the  
686 subtelomeric loci, repair at the BES continues unrestricted, and cells were able to undergo  
687 recombination driven VSG switching. We did not see a change in the access to the genomic  
688 repertoire following a VSG switch, as has been reported upon *TbmRE11* and *TbRAD50*  
689 knockout (Mehnert et al. 2021). Unlike in mammalian cell, we did not detect  
690 hyperphosphorylation of RPA-2 N-terminal tail, rather a single phosphorylation event at S4.  
691 RPA-2 N-terminal phosphorylation is associated with checkpoint activation in mammals  
692 (Byrne and Oakley 2019), and it is possible that this signalling pathways is absent in  
693 trypanosomes. Indeed, in *T. brucei* RPA foci persist throughout the cell cycle following DNA  
694 damage, whilst the foci are only seen in S and G2 phase in mammals (Glover et al. 2019).

695 Protein phosphorylation is a dynamic process (Gelens et al. 2018) and our results show  
696 only a snapshot of the DDR capturing the response at 12 h post DSB induction. Other post  
697 translational modifications are also important to both the DDR (Cremona, Sarangi, and Zhao  
698 2012; Lee et al. 2018; Van and Santos 2018) and VSG switching, with histone methylation and  
699 acetylation important for antigenic variation (Figueiredo, Janzen, and Cross 2008; Glover and

700 Horn 2014; Wang, Kawahara, and Horn 2010), and summoylated proteins enriched at the active  
701 BES (Lopez-Farfan et al. 2014). This study is the first DNA damage phosphoproteome in *T.*  
702 *brucei*, and we have identified an abundance of novel proteins involved in the DDR. Validation  
703 of candidate phosphorylation sites from this dataset will provide key insights into the protein  
704 modifications that govern both DSBR and antigenic variation ins *T. brucei*.

705

#### 706 **Data availability**

707 The mass spectrometry proteomics data have been deposited to the ProteomeXchange  
708 Consortium via the PRIDE (Perez-Riverol et al. 2022) partner repository with the dataset  
709 identifier PXD034455. The the data for this study have been deposited in the European  
710 Nucleotide Archive (ENA) at EMBL-EBI under accession number PRJEB52305  
711 (ERP137006).

712

#### 713 **Acknowledgements**

714 EJM, MM, MU and LG designed the experiments. EJM, ADH, TC performed the experiments,  
715 EJM, QGG and MU performed the statistical analysis. EJM and LG wrote the manuscript, all  
716 authors edited the manuscript. We would also like to thank Sebastian Hutchinson for his  
717 guidance with the analysis of the VSG-sequencing.

718

#### 719 **Funding**

720 Work in the LG laboratory is has received financial support from the Institut Pasteur (G5 Junior  
721 group). EJM is part of the Pasteur - Paris University (PPU) International PhD Program. This  
722 project has received funding from the European Union's Horizon 2020 research and innovation  
723 programme under the Marie Skłodowska-Curie grant agreement No 665807 and from the  
724 Foundation Recherche Médicale grant number FDT202012010602. Funding for open access  
725 charge: Institut Pasteur G5 funding.

726

727 **Figure 1. The <sup>1</sup>HR and VSG<sup>up</sup> DSB proteome** (A) Schematic of chromosome 11  
728 Tb927.11.4530/40 locus, showing both alleles (upper panel: wild type) and then following  
729 modification to generate the <sup>1</sup>HR chromosome-internal DSB cell line with the I-SceI  
730 recognition site, SceR, highlighted (lower panel: <sup>1</sup>HR). The DSB site is flanked upstream by  
731 *red fluorescent protein (RFP)* and *puromycin-N-acetyltransferase (PAC)* downstream. The site  
732 is positioned at an intergenic region between Tb927.11.4530 and Tb927.11.4540, shown as  
733 '4530' and '4540', respectively. Black boxes are tubulin intergenic sequences. (B) Total

734 proteins identified in <sup>1</sup>HR. The x-axis is the Log<sub>2</sub> value of the ratio of each protein given as its  
735 presence in the DSB induced vs uninduced sample. The y-axis is the intensity of a given protein  
736 in the sample. Ribosomal proteins are highlighted in red, all other proteins shown in black. (C)  
737 VSG<sup>up</sup> cell line set up showing the modified BES1 on chromosome 6a. An I-SceI meganuclease  
738 recognition site is inserted upstream of the actively expressed VSG-2, shown with a red vertical  
739 line. The I-SceI-R is flanked downstream by a *puromycin-N-acetyltransferase* gene (PAC).  
740 Arrow; native promoter of the expression site, white boxes; genes, solid black box; 70 bp  
741 repetitive sequence, black circles; telomere. (D) The VSG<sup>up</sup> proteome, with details as described  
742 in (B). Black circle, individual proteins; red circles, ribosomal proteins. Schematics generated  
743 with BioRender.

744

745 **Figure 2. Locus specific phosphoproteome.** (A) Quantification of changes in phosphorylation  
746 in the <sup>1</sup>HR phosphoproteome. Black circles, non-significant change in phosphorylation; blue  
747 circles, significantly enriched phosphorylation sites; green triangle,  $\gamma$ H2A. (B) Quantification  
748 of changes in phosphorylation in the VSG<sup>up</sup> phosphoproteome, details as in (A). (C) Total  
749 number of phosphosites observed in <sup>1</sup>HR and VSG<sup>up</sup> phosphoproteomes, with those sites  
750 identified in both data sets shown. (D) Comparison of phosphorylation sites identified in the  
751 INT and VSG<sup>up</sup> phosphoproteomes. Sites with over two-fold change in phosphoproteomic  
752 analysis are shown.

753

754 **Figure 3. Phosphorylation of proteins involved DSBR.** (A) Quantification of  
755 phosphorylation at specific amino acid sites. (B) Tandem mass spectral data showing the  
756 assignment of T131 and S133 phosphorylation sites on H2A (Tb927.7.2940). The MaxQuant  
757 localization score for each site 1. The loss of a phosphate group (-98 Da) is indicated with a \*.  
758 The fragmentation pattern of the peptide is shown above. The b5 and b6 ions, highlighted on  
759 the spectrum with blue circles, show specific phosphorylation of T131, whilst the y2 and y3  
760 ions highlighted with red circles. (C) Amino acid sequence alignment of the H2A C-terminus  
761 amongst trypanosomatids. Alignments shown are the c-terminus of H2A from *T. brucei*  
762 (Tb927.7.2940), *T. congolense* (TcIL3000\_7\_2140.1), *T. vivax* (TvY486\_0702710), *L.*  
763 *braziliensis* (LbrM.32.1270), *Leishmania amazonensis* (LAMA\_000111100) and *Leishmania*  
764 *donovani* (LdCL\_210016600-t42). Red asterisks denote the S113, T131 and S133  
765 phosphorylation sites; S, serine; T, threonine.

766



767 **Figure 4. The RPA-1<sup>S5A</sup> mutation increases  $\gamma$ H2A DNA damage signalling and disrupts**  
768 **the timing of a chromosome internal DSB.**

769 (A) Amino acid sequence alignment of RPA-1 from *T. brucei* (Tb 927.11.9130), *T. cruzi*  
770 (TcCLB.510901.60) *T. vivax* (TvY486\_1109660), *Leishmania brazillensis* (LbrM.28.1990),  
771 *Saccharomyces cerevisiae* (S288C) and *Homo sapiens* (GI: 4506583). Alignment to the first 60  
772 residues of *T. brucei* RPA-1 is shown. Red boxes indicate phosphorylation sites identified in  
773 SILAC screens. (B) Monitoring of  $\gamma$ H2A foci in the <sup>1</sup>HR and <sup>1</sup>HRRPA-*I*<sup>S5A</sup> cell lines. n>100  
774 for each sample. For the <sup>1</sup>HR cell line error bars represent standard deviation between a pair of  
775 technical replicates. For the <sup>1</sup>HRRPA-*I*<sup>S5A</sup> cell line error bars represent standard deviation  
776 between a pair of biological clones. Significance was calculated using an unpaired t- test. Insert  
777 shows an example of a  $\gamma$ H2A stained nuclei, with  $\gamma$ H2A shown in magenta and DAPI in grey.  
778 (C) Monitoring of RAD51 foci formation in the <sup>1</sup>HR and <sup>1</sup>HRRPA-*I*<sup>S5A</sup> cell lines, n> 100 per  
779 sample. Error bars for <sup>1</sup>HR represent standard deviation of three technical replicates, and error  
780 bars for <sup>1</sup>HRRPA-*I*<sup>S5A</sup> cell line represent standard deviation between a pair of biological clones.  
781 Insert shows a representative RAD51 stained nuclei, with RAD51 foci shown in blue and DAPI  
782 in grey. (D) Percentage of ssDNA measured in the <sup>1</sup>HR and <sup>1</sup>HRRPA-*I*<sup>S5A</sup> cell lines at 0, 6 and  
783 12 h post DSB induction. For the <sup>1</sup>HR cell line, the average and standard deviation of a pair of  
784 technical replicates is shown. For <sup>1</sup>HRRPA-*I*<sup>S5A</sup>, the average and standard deviation of a pair  
785 of biological clones is shown. For all qPCR assays, each replicate is loaded three times on the  
786 qPCR plate. Significance is calculated using an unpaired t-test. (F) Percentage of repair events  
787 occurring by MMEJ or HR among 20 induced <sup>1</sup>HRRPA-*I*<sup>S5A</sup> subclones.

788

789 **Figure 5. VSG<sup>up</sup>RPA-*I*<sup>S5A</sup> mutants have a delay in ssDNA resection however repair at the**

790 **active BES is not disrupted.** (A) Monitoring of  $\gamma$ H2A foci in the <sup>1</sup>HR and <sup>1</sup>HRRPA-*I*<sup>S5A</sup> cell  
791 lines. n>100 for each sample. For the VSG<sup>up</sup> cell line error bars represent standard deviation  
792 between a pair of technical replicates. For the VSG<sup>up</sup>RPA-*I*<sup>S5A</sup> cell line error bars represent  
793 standard deviation between a pair of biological clones. (B) Percentage of ssDNA measured in  
794 VSG<sup>up</sup> and VSG<sup>up</sup>RPA-*I*<sup>S5A</sup> cell lines at 0, 6 and 12 h post DSB induction. For the VSG<sup>up</sup> cell  
795 line, error bars represent the standard deviation of a pair of technical replicates and for  
796 INTRPA-*I*<sup>S5A</sup> error bars represent the standard deviation between a pair of a pair of biological  
797 clones. Significance is calculated using an unpaired t-test. (C) PCR analysis of repair at the  
798 active BES of VSG<sup>up</sup> and VSG<sup>up</sup>RPA-*I*<sup>S5A</sup> sub clones. Upper panel, schematic of the modified  
799 BES1 with black arrows to show the position of primer binding sites used for subclone analysis.

800 Lower panel, PCR analysis of VSG<sup>up</sup> uninduced subclones (- Tet), n=5 and induced subclones  
801 (+ Tet) n=20. VSG<sup>up</sup>RPA-I<sup>S5A</sup> uninduced sub clones n = 5, induced n=22

802

803 **Figure 6. Antigenic variation is not compromised in the VSG<sup>up</sup>RPA-I<sup>S5A</sup> mutants.** (A)

804 Volcano plots showing the significantly enriched VSG genes identified by VSG-seq following  
805 a BES DSB in the VSG<sup>up</sup> and VSG<sup>up</sup>RPA-I<sup>S5A</sup> cell lines. RNA was extracted 0 and 7 days  
806 following I-SceI induction. Red circles represent genes that are significantly up regulated after  
807 7 days induction (log<sub>2</sub> FC >2 and P value < 0.05) and black circles represent genes that are not  
808 significantly up regulated. n = 3. (B) Map of the *T. brucei* 427 genome showing the position of  
809 significantly up regulated VSG genes following a DSB. Megabase chromosomes are shown in  
810 black horizontal lines and genes in grey vertical lines. VSG genes that are significantly up  
811 regulated following a DSB are in highlighted with blue bars for the VSG<sup>up</sup> and red bars for  
812 VSG<sup>up</sup>RPA-I<sup>S5A</sup>. Individual BES's are shown separately on the right-hand side. An enlarged  
813 version of chromosome 6 is shown below.

814

815 **Supplementary Figure legends**

816 **Supplementary Figure 1. Adaptation of the <sup>1</sup>HR and VSG<sup>up</sup> cell lines to growth in SILAC**

817 **medium.** (A) Incorporation of heavy and light labels. (B)  $\gamma$ H2A foci formation in cell lines  
818 adapted to growth in SILAC HMI-9 medium. '- Tet' indicates uninduced cells, '+ Tet' indicates  
819 12 h DSB induction. n > 100 for each count, and the error bars are the standard deviation  
820 between cells grown in 'heavy' and 'light' SILAC HMI-9. Inset, example of a  $\gamma$ H2A positive  
821 nuclei, with  $\gamma$ H2A shown in magenta and the DAPI nuclear stain in grey. Scale bar, 2  $\mu$ m.

822 **Supplementary Figure 2. *T. brucei* DNA damage phosphoproteome.** (A) Distribution of the

823 total phosphorylation sites identified in the <sup>1</sup>HR and VSG<sup>up</sup> DNA damage phosphoproteomes  
824 amongst phospho serine (p<sup>S</sup>), threonine (p<sup>T</sup>) and tyrosine (p<sup>Y</sup>). A comparison to the published  
825 global phosphoproteome of *T. brucei* is shown (Urbaniak et al. 2013). (B) Number of  
826 phosphorylation sites in the <sup>1</sup>HR and VSG<sup>up</sup> phosphoproteomes that are located on proteins  
827 identified as hypothetical or hypothetical conserved.

828

829 **Supplementary Figure 3. Categorical enrichment of GO terms DNA damage responsive**

830 **phosphoproteins.** (A) GO terms enriched in proteins whose phosphorylation increases

831 following (i) an  $^1\text{HR}$  DSB and (ii) a  $\text{VSG}^{\text{up}}$  DSB. (B) GO terms enriched in proteins whose  
832 phosphorylation decreases following (i) an  $^1\text{HR}$  DSB and (ii) a  $\text{VSG}^{\text{up}}$  DSB.

833

834 **Supplementary Figure 4. Generation of  $^1\text{HR}$  RPA-1 $^{\text{S5A}}$  phosphorylation mutants.** (A)

835 Schematic showing the major predicted functional domains of *T. brucei* RPA-1 (Tb  
836 927.11.9130) and *H. sapiens* RPA-1 (GI: 4506583) as predicted by InterPro from the amino

837 acid sequences. (B) Schematic of RPA-1 phosphorylation mutant strategy. Top panel shows

838 both wild type *RPA-1* alleles, with the native serine in position 5 highlighted with a black

839 horizontal bar. US and DS refer to the upstream and downstream regions that were targeted for

840 integration of the mutant allele. The US targeting region is 391 bp in length and DS is 498 bp

841 in length for both alleles. Bottom panel shows the mutated *RPA-1* allele with alanine in position

842 5 shown as a red bar. Allele 1 is replaced with RPA-1 $^{\text{S5A}}$  fused to a *blastidicin* resistance gene,

843 and Allele 2 is replaced with RPA-1 fused to a *neomycin phosphotransferase* gene. Bla;

844 *blastidicine* resistance gene, a-b; *alpha-beta tubulin* intergenic regions, ald; *aldolase* processing

845 sequences, Neo; *neomycin phosphotransferase resistance* gene Black arrows show regions

846 amplified by PCR to validate integration of the cassette Figure created with BioRender.com.

847 (C) PCR validation of integration of replacement of *RPA-1* allele 1 with the *RPA-1 $^{\text{S5A}}$  – Bla* in

848 the INT cell line. pRPA-1 $^{\text{S5A}}$  is the plasmid harbouring the mutant and serves as the positive

849 control. INTRPA-1 $^{\text{S5A}}$  c1 and c2 refer to a pair of biological clones, VSG-2 wt is gDNA

850 extracted from a wild type cell line and serves as a negative control. Expected size of the PCR

851 product is 2246 bp. (D) PCR validation of integration of replacement of *RPA-1* allele 2 with

852 the *RPA-1 $^{\text{S5A}}$  – Neo* in the INT cell line. Samples as described in (B). Expected size of the PCR

853 product is 2333 bp. (E) Cumulative growth of the INT and INTRPA-1 $^{\text{S5A}}$  cell lines over 96 h.

854 INT and INTRPA-1 $^{\text{S5A}}$  cell lines are shown in black and red lines, respectively, and dashed

855 lines indicate growth under DSB inducing conditions. Error bars represent standard deviation

856 between a single induction in a pair of biological clones.

857

858 **Supplementary Figure 5. Analysis of repaired  $^1\text{HR}$  RPA-1 $^{\text{S5A}}$  clones.** Above, schematic

859 showing binding site of primers used to assess INT DSB repair. Below, PCR analysis of 5

860 uninduced subclones ('-Tet') and 11 induced subclones ('+Tet'). Data for 9 induced subclones

861 not shown. Expected size of PCR product in uninduced clones is 1.314 Kb.

862

863 **Supplementary Figure 6. Generation of  $\text{VSG}^{\text{up}}$ RPA-1 $^{\text{S5A}}$  phosphorylation mutants.** (A)

864 PCR to confirm replacement of one RPA-1 allele with RPA-1 $^{\text{S5A}}$  fused to a *blastidicin*

865 resistance cassette in the VSG<sup>up</sup> cell line. Primer binding sites used for the PCR shown are  
866 shown as black arrows. C1 and C2 refer to a pair of VSG<sup>up</sup>RPA-1<sup>S5A</sup> phosphorylation mutants,  
867 pRPA-1S5A is the plasmid and used as a positive control, VSG-2 WT is an unmodified cell line  
868 used as negative control. Expected size of the PCR product is 2246 bp. (B) PCR to confirm  
869 replacement of the second *RPA-1* allele with *RPA-1S5A* fused to a Neomycin resistance gene  
870 in the VSG<sup>up</sup> cell line. pRPA-1<sup>S5A</sup> is the plasmid harbouring the mutant and serves as the  
871 positive control. Primer binding sites used for the PCR shown are shown as black arrows.  
872 Expected size of the PCR product is 2333 bp. (C) Cumulative growth of the VSG<sup>up</sup> and  
873 VSG<sup>up</sup>RPA-1<sup>S5A</sup> cell lines over 96 h. VSG<sup>up</sup> and VSG<sup>up</sup>RPA-1<sup>S5A</sup> cell lines are shown in black  
874 and red lines, respectively and dashed lines indicate growth under DSB inducing conditions.  
875 Error bars represent standard deviation between a single induction in a pair of biological clones.  
876 (D) Immunofluorescence analysis of surface VSGs in the VSG<sup>up</sup> and VSG<sup>up</sup>RPA-1<sup>S5A</sup> cell lines,  
877 in uninduced and 7 days DSB induced samples (+ Tet). VSG-2 is the surface VSG in the VSG<sup>up</sup>  
878 cell line prior to DSB induction. VSG-X refers to all VSGs except VSG-2 and represents the  
879 proportion of cells that no longer have VSG-2 at the surface and have therefore undergone VSG  
880 switching. Error bars for VSG<sup>up</sup>RPA-1<sup>S5A</sup> cell line represent standard deviation between a pair  
881 of biological clones. n>100 for each sample. Panel on the right shows VSG<sup>up</sup>RPA-1<sup>S5A</sup> cells  
882 before DSB induction (-Tet) and 7 days post DSB induction (+ Tet), stained using antibodies  
883 specific to VSG-2.

884

885 **Supplementary Figure 7. Analysis of repaired VSG<sup>up</sup>RPA-1<sup>S5A</sup> clones.** (A) VSG<sup>up</sup> subclone  
886 analysis of *VSG-2*, *pseudo* and *ESAG1* which have an expected PCR product size of 527bp,  
887 550bp and 380bp, respectively. Lanes 1-5 are uninduced subclones (-Tet) and lanes 6 – 25 are  
888 induced (+ Tet). (B) VSG<sup>up</sup>RPA-1<sup>S5A</sup> subclone analysis of *VSG-2*, *pseudo* and *ESAG1*. Lanes  
889 6 -27 are induced subclones.

890

## 891 **References**

- 892 Aguilera, A., and T. Garcia-Muse. 2012. 'R loops: from transcription byproducts to threats to  
893 genome stability', *Mol Cell*, 46: 115-24.
- 894 Aitchison, N., S. Talbot, J. Shapiro, K. Hughes, C. Adkin, T. Butt, K. Shearer, and G. Rudenko.  
895 2005. 'VSG switching in *Trypanosoma brucei*: antigenic variation analysed using RNAi  
896 in the absence of immune selection', *Molecular microbiology*, 57: 1608-22.
- 897 Alsford, S., T. Kawahara, C. Isamah, and D. Horn. 2007. 'A sirtuin in the African trypanosome  
898 is involved in both DNA repair and telomeric gene silencing but is not required for  
899 antigenic variation', *Mol Microbiol*, 63: 724-36.
- 900 Amos, B., C. Aurrecochea, M. Barba, A. Barreto, E. Y. Basenko, W. Bazant, R. Belnap, A. S.  
901 Blevins, U. Bohme, J. Brestelli, B. P. Brunk, M. Caddick, D. Callan, L. Campbell, M.

- 902 B. Christensen, G. K. Christophides, K. Crouch, K. Davis, J. DeBarry, R. Doherty, Y.  
903 Duan, M. Dunn, D. Falke, S. Fisher, P. Flicek, B. Fox, B. Gajria, G. I. Giraldo-Calderon,  
904 O. S. Harb, E. Harper, C. Hertz-Fowler, M. J. Hickman, C. Howington, S. Hu, J.  
905 Humphrey, J. Iodice, A. Jones, J. Judkins, S. A. Kelly, J. C. Kissinger, D. K. Kwon, K.  
906 Lamoureux, D. Lawson, W. Li, K. Lies, D. Lodha, J. Long, R. M. MacCallum, G.  
907 Maslen, M. A. McDowell, J. Nabrzyski, D. S. Roos, S. S. C. Rund, S. W. Schulman, A.  
908 Shanmugasundram, V. Sitnik, D. Spruill, D. Starns, C. J. Stoeckert, S. S. Tomko, H.  
909 Wang, S. Warrenfeltz, R. Wieck, P. A. Wilkinson, L. Xu, and J. Zheng. 2022.  
910 'VEuPathDB: the eukaryotic pathogen, vector and host bioinformatics resource center',  
911 *Nucleic Acids Res*, 50: D898-D911.
- 912 Benmerzouga, I., J. Concepcion-Acevedo, H. S. Kim, A. V. Vadoros, G. A. Cross, M. M.  
913 Klingbeil, and B. Li. 2013. 'Trypanosoma brucei Orc1 is essential for nuclear DNA  
914 replication and affects both VSG silencing and VSG switching', *Mol Microbiol*, 87: 196-  
915 210.
- 916 Bennetzen, M. V., D. H. Larsen, J. Bunkenborg, J. Bartek, J. Lukas, and J. S. Andersen. 2010.  
917 'Site-specific phosphorylation dynamics of the nuclear proteome during the DNA  
918 damage response', *Mol Cell Proteomics*, 9: 1314-23.
- 919 Bensimon, A., A. Schmidt, Y. Ziv, R. Elkon, S. Y. Wang, D. J. Chen, R. Aebersold, and Y.  
920 Shiloh. 2010. 'ATM-dependent and -independent dynamics of the nuclear  
921 phosphoproteome after DNA damage', *Sci Signal*, 3: rs3.
- 922 Benz, C., and M. D. Urbaniak. 2019. 'Organising the cell cycle in the absence of transcriptional  
923 control: Dynamic phosphorylation co-ordinates the Trypanosoma brucei cell cycle post-  
924 transcriptionally', *PLoS Pathog*, 15: e1008129.
- 925 Berriman, M., E. Ghedin, C. Hertz-Fowler, G. Blandin, H. Renauld, D. C. Bartholomeu, N. J.  
926 Lennard, E. Caler, N. E. Hamlin, B. Haas, U. Bohme, L. Hannick, M. A. Aslett, J.  
927 Shallom, L. Marcello, L. Hou, B. Wickstead, U. C. Alsmark, C. Arrowsmith, R. J.  
928 Atkin, A. J. Barron, F. Bringaud, K. Brooks, M. Carrington, I. Cherevach, T. J.  
929 Chillingworth, C. Churcher, L. N. Clark, C. H. Corton, A. Cronin, R. M. Davies, J.  
930 Doggett, A. Djikeng, T. Feldblyum, M. C. Field, A. Fraser, I. Goodhead, Z. Hance, D.  
931 Harper, B. R. Harris, H. Hauser, J. Hostetler, A. Ivens, K. Jagels, D. Johnson, J. Johnson,  
932 K. Jones, A. X. Kerhornou, H. Koo, N. Larke, S. Landfear, C. Larkin, V. Leech, A.  
933 Line, A. Lord, A. Macleod, P. J. Mooney, S. Moule, D. M. Martin, G. W. Morgan, K.  
934 Mungall, H. Norbertczak, D. Ormond, G. Pai, C. S. Peacock, J. Peterson, M. A. Quail,  
935 E. Rabinowitsch, M. A. Rajandream, C. Reitter, S. L. Salzberg, M. Sanders, S.  
936 Schobel, S. Sharp, M. Simmonds, A. J. Simpson, L. Tallon, C. M. Turner, A. Tait, A.  
937 R. Tivey, S. Van Aken, D. Walker, D. Wanless, S. Wang, B. White, O. White, S.  
938 Whitehead, J. Woodward, J. Wortman, M. D. Adams, T. M. Embley, K. Gull, E. Ullu,  
939 J. D. Barry, A. H. Fairlamb, F. Opperdoes, B. G. Barrell, J. E. Donelson, N. Hall, C. M.  
940 Fraser, S. E. Melville, and N. M. El-Sayed. 2005. 'The genome of the African  
941 trypanosome Trypanosoma brucei', *Science*, 309: 416-22.
- 942 Black, J. A., K. Crouch, L. Lemgruber, C. Lapsley, N. Dickens, L. R. O. Tosi, J. C. Mottram,  
943 and R. McCulloch. 2020. 'Trypanosoma brucei ATR Links DNA Damage Signaling  
944 during Antigenic Variation with Regulation of RNA Polymerase I-Transcribed Surface  
945 Antigens', *Cell Rep*, 30: 836-51 e5.
- 946 Bochkarev, A., R. A. Pfuetzner, A. M. Edwards, and L. Frappier. 1997. 'Structure of the single-  
947 stranded-DNA-binding domain of replication protein A bound to DNA', *Nature*, 385:  
948 176-81.
- 949 Boothroyd, C. E., O. Dreesen, T. Leonova, K. I. Ly, L. M. Figueiredo, G. A. Cross, and F. N.  
950 Papavasiliou. 2009. 'A yeast-endonuclease-generated DNA break induces antigenic  
951 switching in Trypanosoma brucei', *Nature*, 459: 278-81.

- 952 Briggs, E., G. Hamilton, K. Crouch, C. Lapsley, and R. McCulloch. 2018. 'Genome-wide  
953 mapping reveals conserved and diverged R-loop activities in the unusual genetic  
954 landscape of the African trypanosome genome', *Nucleic Acids Res*, 46: 11789-805.
- 955 Byrne, B. M., and G. G. Oakley. 2019. 'Replication protein A, the laxative that keeps DNA  
956 regular: The importance of RPA phosphorylation in maintaining genome stability',  
957 *Semin Cell Dev Biol*, 86: 112-20.
- 958 Caljon, G., N. Van Reet, C. De Trez, M. Vermeersch, D. Perez-Morga, and J. Van Den Abbeele.  
959 2016. 'The Dermis as a Delivery Site of *Trypanosoma brucei* for Tsetse Flies', *PLoS*  
960 *Pathog*, 12: e1005744.
- 961 Capewell, P., C. Cren-Travaille, F. Marchesi, P. Johnston, C. Clucas, R. A. Benson, T. A.  
962 Gorman, E. Calvo-Alvarez, A. Crouzols, G. Jouvion, V. Jamonneau, W. Weir, M. L.  
963 Stevenson, K. O'Neill, A. Cooper, N. K. Swar, B. Bucheton, D. M. Ngoyi, P. Garside,  
964 B. Rotureau, and A. MacLeod. 2016. 'The skin is a significant but overlooked  
965 anatomical reservoir for vector-borne African trypanosomes', *Elife*, 5.
- 966 Celeste, A., O. Fernandez-Capetillo, M. J. Kruhlak, D. R. Pilch, D. W. Staudt, A. Lee, R. F.  
967 Bonner, W. M. Bonner, and A. Nussenzweig. 2003. 'Histone H2AX phosphorylation is  
968 dispensable for the initial recognition of DNA breaks', *Nat Cell Biol*, 5: 675-9.
- 969 Conway, C., R. McCulloch, M. L. Ginger, N. P. Robinson, A. Browitt, and J. D. Barry. 2002.  
970 'Ku is important for telomere maintenance, but not for differential expression of  
971 telomeric VSG genes, in African trypanosomes', *J Biol Chem*, 277: 21269-77.
- 972 Cremona, C. A., P. Sarangi, and X. Zhao. 2012. 'Sumoylation and the DNA damage response',  
973 *Biomolecules*, 2: 376-88.
- 974 Cross, G. A. 1975. 'Identification, purification and properties of clone-specific glycoprotein  
975 antigens constituting the surface coat of *Trypanosoma brucei*', *Parasitology*, 71: 393-  
976 417.
- 977 Cross, G. A., H. S. Kim, and B. Wickstead. 2014. 'Capturing the variant surface glycoprotein  
978 repertoire (the VSGnome) of *Trypanosoma brucei* Lister 427', *Mol Biochem Parasitol*,  
979 195: 59-73.
- 980 De Lange, T., J. M. Kooter, P. A. Michels, and P. Borst. 1983. 'Telomere conversion in  
981 trypanosomes', *Nucleic Acids Res*, 11: 8149-65.
- 982 Devlin, R., C. A. Marques, D. Paape, M. Prorocic, A. C. Zurita-Leal, S. J. Campbell, C. Lapsley,  
983 N. Dickens, and R. McCulloch. 2016. 'Mapping replication dynamics in *Trypanosoma*  
984 *brucei* reveals a link with telomere transcription and antigenic variation', *Elife*, 5.
- 985 Dobson, R., C. Stockdale, C. Lapsley, J. Wilkes, and R. McCulloch. 2011. 'Interactions among  
986 *Trypanosoma brucei* RAD51 paralogues in DNA repair and antigenic variation',  
987 *Molecular microbiology*, 81: 434-56.
- 988 Dutertre, M., and S. Vagner. 2017. 'DNA-Damage Response RNA-Binding Proteins  
989 (DDRBP)s: Perspectives from a New Class of Proteins and Their RNA Targets', *J Mol*  
990 *Biol*, 429: 3139-45.
- 991 Figueiredo, L. M., C. J. Janzen, and G. A. Cross. 2008. 'A histone methyltransferase modulates  
992 antigenic variation in African trypanosomes', *PLoS Biol*, 6: e161.
- 993 Gelens, L., J. Qian, M. Bollen, and A. T. Saurin. 2018. 'The Importance of Kinase-Phosphatase  
994 Integration: Lessons from Mitosis', *Trends Cell Biol*, 28: 6-21.
- 995 Glover, L., S. Alsford, C. Beattie, and D. Horn. 2007. 'Deletion of a trypanosome telomere  
996 leads to loss of silencing and progressive loss of terminal DNA in the absence of cell  
997 cycle arrest', *Nucleic acids research*, 35: 872-80.
- 998 Glover, L., S. Alsford, and D. Horn. 2013. 'DNA break site at fragile subtelomeres determines  
999 probability and mechanism of antigenic variation in African trypanosomes', *PLoS*  
1000 *Pathog*, 9: e1003260.

- 1001 Glover, L., and D. Horn. 2012. 'Trypanosomal histone gammaH2A and the DNA damage  
1002 response', *Mol Biochem Parasitol*, 183: 78-83.
- 1003 ———. 2014. 'Locus-specific control of DNA resection and suppression of subtelomeric VSG  
1004 recombination by HAT3 in the African trypanosome', *Nucleic Acids Res*, 42: 12600-13.
- 1005 Glover, L., C. A. Marques, O. Suska, and D. Horn. 2019. 'Persistent DNA Damage Foci and  
1006 DNA Replication with a Broken Chromosome in the African Trypanosome', *mBio*, 10.
- 1007 Glover, L., R. McCulloch, and D. Horn. 2008. 'Sequence homology and microhomology  
1008 dominate chromosomal double-strand break repair in African trypanosomes', *Nucleic  
1009 Acids Res*, 36: 2608-18.
- 1010 Hartley, C. L., and R. McCulloch. 2008. 'Trypanosoma brucei BRCA2 acts in antigenic  
1011 variation and has undergone a recent expansion in BRC repeat number that is important  
1012 during homologous recombination', *Mol Microbiol*, 68: 1237-51.
- 1013 Hertz-Fowler, C., L. M. Figueiredo, M. A. Quail, M. Becker, A. Jackson, N. Bason, K. Brooks,  
1014 C. Churcher, S. Fahkro, I. Goodhead, P. Heath, M. Kartvelishvili, K. Mungall, D.  
1015 Harris, H. Hauser, M. Sanders, D. Saunders, K. Seeger, S. Sharp, J. E. Taylor, D.  
1016 Walker, B. White, R. Young, G. A. Cross, G. Rudenko, J. D. Barry, E. J. Louis, and M.  
1017 Berriman. 2008. 'Telomeric expression sites are highly conserved in Trypanosoma  
1018 brucei', *PLoS One*, 3: e3527.
- 1019 Horn, D. 2014. 'Antigenic variation in African trypanosomes', *Mol Biochem Parasitol*, 195:  
1020 123-9.
- 1021 Keskin, H., Y. Shen, F. Huang, M. Patel, T. Yang, K. Ashley, A. V. Mazin, and F. Storici. 2014.  
1022 'Transcript-RNA-templated DNA recombination and repair', *Nature*, 515: 436-9.
- 1023 Kim, H. S., and G. A. Cross. 2010. 'TOPO3alpha influences antigenic variation by monitoring  
1024 expression-site-associated VSG switching in Trypanosoma brucei', *PLoS Pathog*, 6:  
1025 e1000992.
- 1026 ———. 2011. 'Identification of Trypanosoma brucei RMI1/BLAP75 homologue and its roles  
1027 in antigenic variation', *PLoS One*, 6: e25313.
- 1028 Kruhlik, M., E. E. Crouch, M. Orlov, C. Montano, S. A. Gorski, A. Nussenzweig, T. Misteli,  
1029 R. D. Phair, and R. Casellas. 2007. 'The ATM repair pathway inhibits RNA polymerase  
1030 I transcription in response to chromosome breaks', *Nature*, 447: 730-4.
- 1031 Laffitte, M. C., M. M. Genois, A. Mukherjee, D. Legare, J. Y. Masson, and M. Ouellette. 2014.  
1032 'Formation of linear amplicons with inverted duplications in Leishmania requires the  
1033 MRE11 nuclease', *PLoS Genet*, 10: e1004805.
- 1034 Laffitte, M. C., P. Leprohon, M. Hainse, D. Legare, J. Y. Masson, and M. Ouellette. 2016.  
1035 'Chromosomal Translocations in the Parasite Leishmania by a MRE11/RAD50-  
1036 Independent Microhomology-Mediated End Joining Mechanism', *PLoS Genet*, 12:  
1037 e1006117.
- 1038 Langmead, B., and S. L. Salzberg. 2012. 'Fast gapped-read alignment with Bowtie 2', *Nat  
1039 Methods*, 9: 357-9.
- 1040 Lee, N. S., S. Kim, Y. W. Jung, and H. Kim. 2018. 'Eukaryotic DNA damage responses:  
1041 Homologous recombination factors and ubiquitin modification', *Mutat Res*, 809: 88-98.
- 1042 Lo, T., L. Pellegrini, A. R. Venkitaraman, and T. L. Blundell. 2003. 'Sequence fingerprints in  
1043 BRCA2 and RAD51: implications for DNA repair and cancer', *DNA Repair (Amst)*, 2:  
1044 1015-28.
- 1045 Lopez-Farfan, D., J. M. Bart, D. I. Rojas-Barros, and M. Navarro. 2014. 'SUMOylation by the  
1046 E3 ligase TbSIZ1/PIAS1 positively regulates VSG expression in Trypanosoma brucei',  
1047 *PLoS Pathog*, 10: e1004545.
- 1048 Mankouri, H. W., and I. D. Hickson. 2007. 'The RecQ helicase-topoisomerase III-Rmi1  
1049 complex: a DNA structure-specific 'dissolvasome'?', *Trends Biochem Sci*, 32: 538-46.

- 1050 Marechal, A., and L. Zou. 2013. 'DNA damage sensing by the ATM and ATR kinases', *Cold*  
1051 *Spring Harb Perspect Biol*, 5.
- 1052 Marin, P. A., R. Obonaga, R. S. Pavani, M. S. da Silva, C. B. de Araujo, A. A. Lima, C. C.  
1053 Avila, I. Cestari, C. R. Machado, and M. C. Elias. 2020. 'ATR Kinase Is a Crucial Player  
1054 Mediating the DNA Damage Response in *Trypanosoma brucei*', *Front Cell Dev Biol*, 8:  
1055 602956.
- 1056 Matsuoka, S., B. A. Ballif, A. Smogorzewska, E. R. McDonald, 3rd, K. E. Hurov, J. Luo, C. E.  
1057 Bakalarski, Z. Zhao, N. Solimini, Y. Lerenthal, Y. Shiloh, S. P. Gygi, and S. J. Elledge.  
1058 2007. 'ATM and ATR substrate analysis reveals extensive protein networks responsive  
1059 to DNA damage', *Science*, 316: 1160-6.
- 1060 McCulloch, R., and J. D. Barry. 1999. 'A role for RAD51 and homologous recombination in  
1061 *Trypanosoma brucei* antigenic variation', *Genes Dev*, 13: 2875-88.
- 1062 Mehnert, A. K., M. Prorocic, A. Dujeancourt-Henry, S. Hutchinson, R. McCulloch, and L.  
1063 Glover. 2021. 'The MRN complex promotes DNA repair by homologous recombination  
1064 and restrains antigenic variation in African trypanosomes', *Nucleic Acids Res*, 49: 1436-  
1065 54.
- 1066 Mehta, A., and J. E. Haber. 2014. 'Sources of DNA double-strand breaks and models of  
1067 recombinational DNA repair', *Cold Spring Harb Perspect Biol*, 6: a016428.
- 1068 Moore, J. D., O. Yazgan, Y. Ataian, and J. E. Krebs. 2007. 'Diverse roles for histone H2A  
1069 modifications in DNA damage response pathways in yeast', *Genetics*, 176: 15-25.
- 1070 Mugnier, M. R., G. A. Cross, and F. N. Papavasiliou. 2015. 'The in vivo dynamics of antigenic  
1071 variation in *Trypanosoma brucei*', *Science*, 347: 1470-3.
- 1072 Myler, P. J., A. L. Allen, N. Agabian, and K. Stuart. 1985. 'Antigenic variation in clones of  
1073 *Trypanosoma brucei* grown in immune-deficient mice', *Infect Immun*, 47: 684-90.
- 1074 Nanavaty, V., R. Sandhu, S. E. Jehi, U. M. Pandya, and B. Li. 2017. '*Trypanosoma brucei* RAP1  
1075 maintains telomere and subtelomere integrity by suppressing TERRA and telomeric  
1076 RNA:DNA hybrids', *Nucleic Acids Res*, 45: 5785-96.
- 1077 Neto, J. L., C. B. Lira, M. A. Giardini, L. Khater, A. M. Perez, L. A. Peroni, J. R. dos Reis, L.  
1078 H. Freitas-Junior, C. H. Ramos, and M. I. Cano. 2007. 'Leishmania replication protein  
1079 A-1 binds in vivo single-stranded telomeric DNA', *Biochem Biophys Res Commun*, 358:  
1080 417-23.
- 1081 Nishida, K., Y. Kuwano, T. Nishikawa, K. Masuda, and K. Rokutan. 2017. 'RNA Binding  
1082 Proteins and Genome Integrity', *Int J Mol Sci*, 18.
- 1083 Ogawa, L. M., and S. J. Baserga. 2017. 'Crosstalk between the nucleolus and the DNA damage  
1084 response', *Mol Biosyst*, 13: 443-55.
- 1085 Ohle, C., R. Tesorero, G. Schermann, N. Dobrev, I. Sinning, and T. Fischer. 2016. 'Transient  
1086 RNA-DNA Hybrids Are Required for Efficient Double-Strand Break Repair', *Cell*, 167:  
1087 1001-13 e7.
- 1088 Ong, S. E., B. Blagoev, I. Kratchmarova, D. B. Kristensen, H. Steen, A. Pandey, and M. Mann.  
1089 2002. 'Stable isotope labeling by amino acids in cell culture, SILAC, as a simple and  
1090 accurate approach to expression proteomics', *Mol Cell Proteomics*, 1: 376-86.
- 1091 Pavani, R. S., M. S. da Silva, C. A. Fernandes, F. S. Morini, C. B. Araujo, M. R. Fontes, O. A.  
1092 Sant'Anna, C. R. Machado, M. I. Cano, S. P. Fragoso, and M. C. Elias. 2016.  
1093 'Replication Protein A Presents Canonical Functions and Is Also Involved in the  
1094 Differentiation Capacity of *Trypanosoma cruzi*', *PLoS Negl Trop Dis*, 10: e0005181.
- 1095 Pavani, R. S., C. Fernandes, A. M. Perez, E. J. Vasconcelos, J. L. Siqueira-Neto, M. R. Fontes,  
1096 and M. I. Cano. 2014. 'RPA-1 from *Leishmania amazonensis* (LaRPA-1) structurally  
1097 differs from other eukaryote RPA-1 and interacts with telomeric DNA via its N-terminal  
1098 OB-fold domain', *FEBS Lett*, 588: 4740-8.



- 1099 Pays, E. 1985. 'Gene conversion in trypanosome antigenic variation', *Prog Nucleic Acid Res*  
1100 *Mol Biol*, 32: 1-26.
- 1101 Pays, E., S. Van Assel, M. Laurent, M. Darville, T. Vervoort, N. Van Meirvenne, and M.  
1102 Steinert. 1983. 'Gene conversion as a mechanism for antigenic variation in  
1103 trypanosomes', *Cell*, 34: 371-81.
- 1104 Perez-Riverol, Y., J. Bai, C. Bandla, D. Garcia-Seisdedos, S. Hewapathirana, S.  
1105 Kamatchinathan, D. J. Kundu, A. Prakash, A. Frericks-Zipper, M. Eisenacher, M.  
1106 Walzer, S. Wang, A. Brazma, and J. A. Vizcaino. 2022. 'The PRIDE database resources  
1107 in 2022: a hub for mass spectrometry-based proteomics evidences', *Nucleic Acids Res*,  
1108 50: D543-D52.
- 1109 Price, B. D., and A. D. D'Andrea. 2013. 'Chromatin remodeling at DNA double-strand breaks',  
1110 *Cell*, 152: 1344-54.
- 1111 Proudfoot, C., and R. McCulloch. 2005. 'Distinct roles for two RAD51-related genes in  
1112 *Trypanosoma brucei* antigenic variation', *Nucleic Acids Res*, 33: 6906-19.
- 1113 Redon, C., D. Pilch, E. Rogakou, O. Sedelnikova, K. Newrock, and W. Bonner. 2002. 'Histone  
1114 H2A variants H2AX and H2AZ', *Curr Opin Genet Dev*, 12: 162-9.
- 1115 Riepe, C., E. Zelin, P. A. Frankino, Z. A. Meacham, S. G. Fernandez, N. T. Ingolia, and J. E.  
1116 Corn. 2021. 'Double stranded DNA breaks and genome editing trigger loss of ribosomal  
1117 protein RPS27A', *FEBS J*.
- 1118 Robinson, N. P., N. Burman, S. E. Melville, and J. D. Barry. 1999. 'Predominance of duplicative  
1119 VSG gene conversion in antigenic variation in African trypanosomes', *Molecular and*  
1120 *cellular biology*, 19: 5839-46.
- 1121 Robinson, N. P., R. McCulloch, C. Conway, A. Browitt, and J. D. Barry. 2002. 'Inactivation of  
1122 Mre11 does not affect VSG gene duplication mediated by homologous recombination  
1123 in *Trypanosoma brucei*', *J Biol Chem*, 277: 26185-93.
- 1124 Rogakou, E. P., D. R. Pilch, A. H. Orr, V. S. Ivanova, and W. M. Bonner. 1998. 'DNA double-  
1125 stranded breaks induce histone H2AX phosphorylation on serine 139', *J Biol Chem*,  
1126 273: 5858-68.
- 1127 Rudenko, G., R. McCulloch, A. Dirks-Mulder, and P. Borst. 1996. 'Telomere exchange can be  
1128 an important mechanism of variant surface glycoprotein gene switching in  
1129 *Trypanosoma brucei*', *Mol Biochem Parasitol*, 80: 65-75.
- 1130 Siegel, T. N., T. Kawahara, J. A. Degrasse, C. J. Janzen, D. Horn, and G. A. Cross. 2008.  
1131 'Acetylation of histone H4K4 is cell cycle regulated and mediated by HAT3 in  
1132 *Trypanosoma brucei*', *Mol Microbiol*, 67: 762-71.
- 1133 Sollier, J., C. T. Stork, M. L. Garcia-Rubio, R. D. Paulsen, A. Aguilera, and K. A. Cimprich.  
1134 2014. 'Transcription-coupled nucleotide excision repair factors promote R-loop-  
1135 induced genome instability', *Mol Cell*, 56: 777-85.
- 1136 Tan, K. S., S. T. Leal, and G. A. Cross. 2002. '*Trypanosoma brucei* MRE11 is non-essential but  
1137 influences growth, homologous recombination and DNA double-strand break repair',  
1138 *Mol Biochem Parasitol*, 125: 11-21.
- 1139 Trenaman, A., C. Hartley, M. Prorocic, D. G. Passos-Silva, M. van den Hoek, V. Nechyporuk-  
1140 Zloy, C. R. Machado, and R. McCulloch. 2013. '*Trypanosoma brucei* BRCA2 acts in a  
1141 life cycle-specific genome stability process and dictates BRC repeat number-dependent  
1142 RAD51 subnuclear dynamics', *Nucleic Acids Res*, 41: 943-60.
- 1143 Trindade, S., F. Rijo-Ferreira, T. Carvalho, D. Pinto-Neves, F. Guegan, F. Aresta-Branco, F.  
1144 Bento, S. A. Young, A. Pinto, J. Van Den Abbeele, R. M. Ribeiro, S. Dias, T. K. Smith,  
1145 and L. M. Figueiredo. 2016. '*Trypanosoma brucei* Parasites Occupy and Functionally  
1146 Adapt to the Adipose Tissue in Mice', *Cell Host Microbe*, 19: 837-48.
- 1147 Urbaniak, M. D., D. M. Martin, and M. A. Ferguson. 2013. 'Global quantitative SILAC  
1148 phosphoproteomics reveals differential phosphorylation is widespread between the

- 1149           procyclic and bloodstream form lifecycle stages of *Trypanosoma brucei*', *J Proteome*  
1150           *Res*, 12: 2233-44.
- 1151 Van, H. T., and M. A. Santos. 2018. 'Histone modifications and the DNA double-strand break  
1152           response', *Cell Cycle*, 17: 2399-410.
- 1153 von Stechow, L., and J. V. Olsen. 2017. 'Proteomics insights into DNA damage response and  
1154           translating this knowledge to clinical strategies', *Proteomics*, 17.
- 1155 Wang, Q. P., T. Kawahara, and D. Horn. 2010. 'Histone deacetylases play distinct roles in  
1156           telomeric VSG expression site silencing in African trypanosomes', *Mol Microbiol*, 77:  
1157           1237-45.
- 1158 Wong, A. K., R. Pero, P. A. Ormonde, S. V. Tavtigian, and P. L. Bartel. 1997. 'RAD51 interacts  
1159           with the evolutionarily conserved BRC motifs in the human breast cancer susceptibility  
1160           gene *brca2*', *J Biol Chem*, 272: 31941-4.
- 1161 Xiao, A., H. Li, D. Shechter, S. H. Ahn, L. A. Fabrizio, H. Erdjument-Bromage, S. Ishibe-  
1162           Murakami, B. Wang, P. Tempst, K. Hofmann, D. J. Patel, S. J. Elledge, and C. D. Allis.  
1163           2009. 'WSTF regulates the H2A.X DNA damage response via a novel tyrosine kinase  
1164           activity', *Nature*, 457: 57-62.
- 1165 Xie, A., S. Odate, G. Chandramouly, and R. Scully. 2010. 'H2AX post-translational  
1166           modifications in the ionizing radiation response and homologous recombination', *Cell*  
1167           *Cycle*, 9: 3602-10.
- 1168 Zhou, C., A. E. Elia, M. L. Naylor, N. Dephoure, B. A. Ballif, G. Goel, Q. Xu, A. Ng, D. M.  
1169           Chou, R. J. Xavier, S. P. Gygi, and S. J. Elledge. 2016. 'Profiling DNA damage-induced  
1170           phosphorylation in budding yeast reveals diverse signaling networks', *Proc Natl Acad*  
1171           *Sci U S A*, 113: E3667-75.
- 1172 Zierhut, C., and J. F. Diffley. 2008. 'Break dosage, cell cycle stage and DNA replication  
1173           influence DNA double strand break response', *EMBO J*, 27: 1875-85.
- 1174

Figure 1.

A

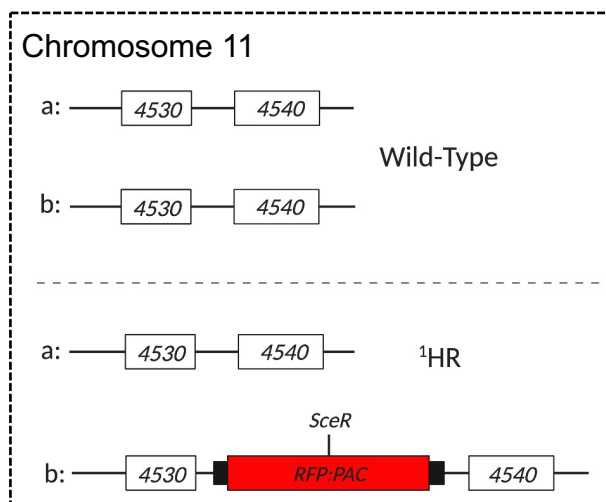

B

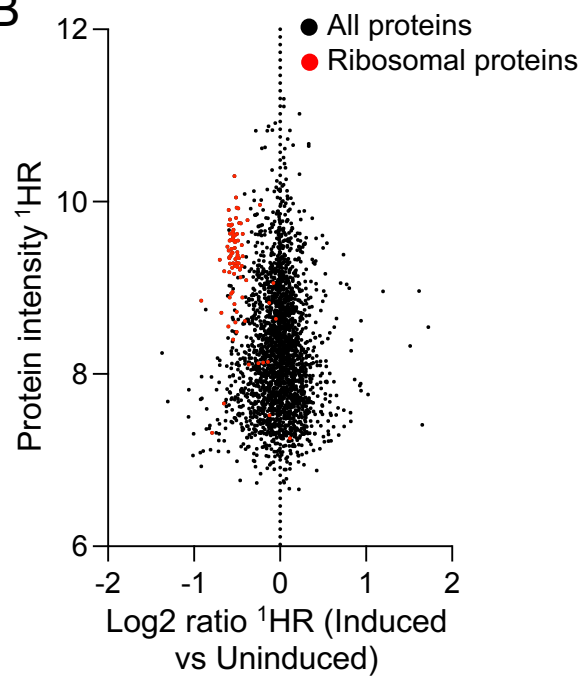

C

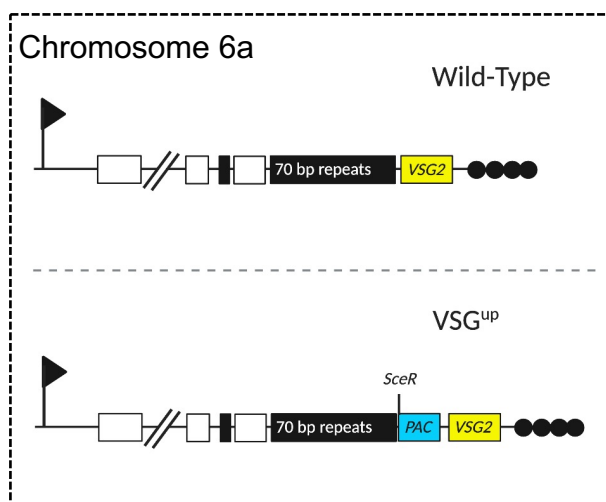

D

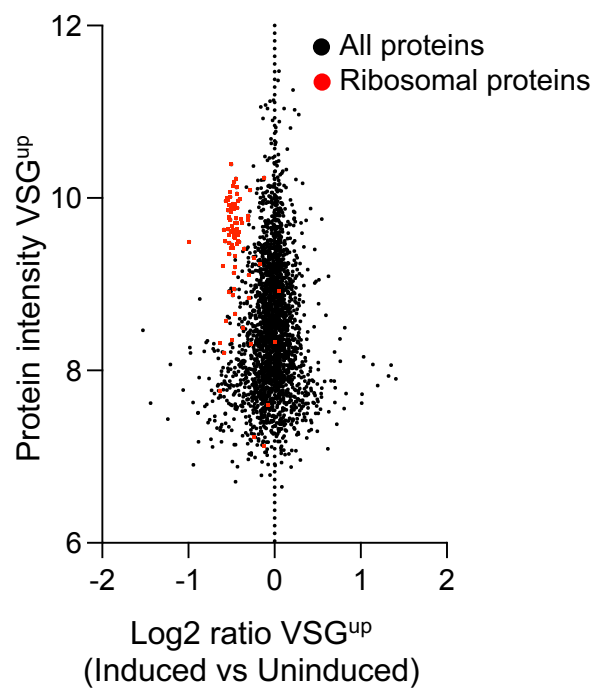
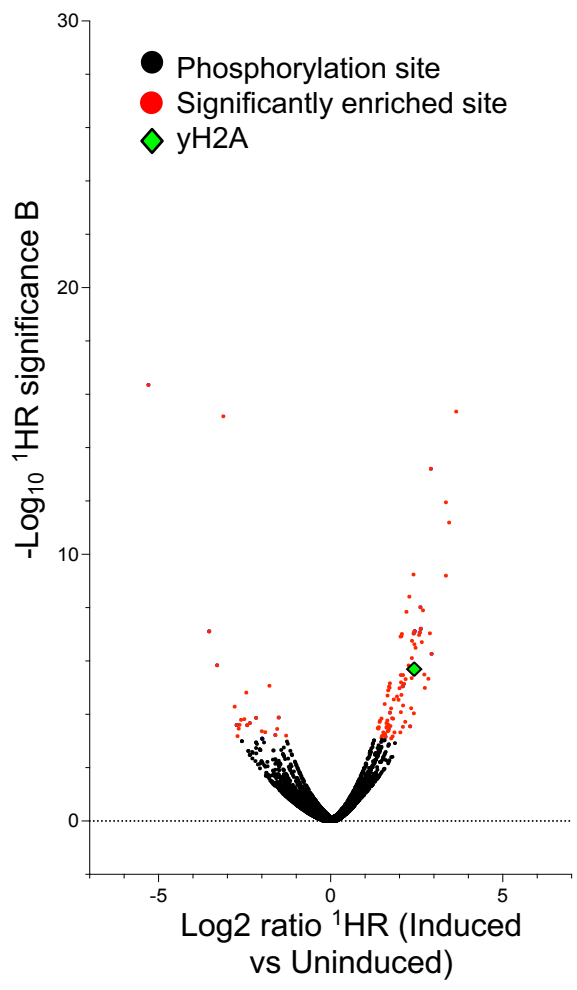
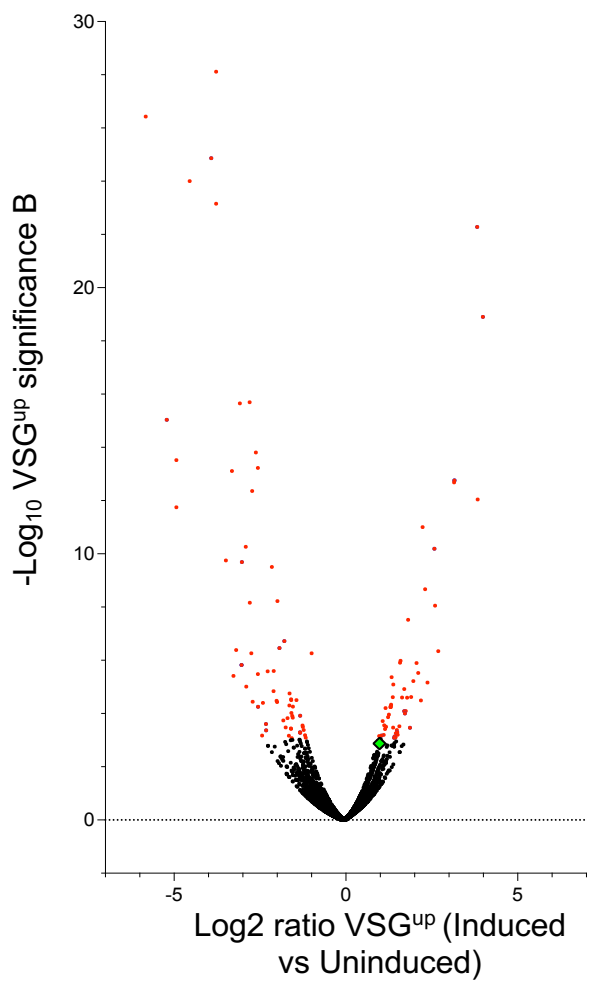

Figure 2.

A



B



C

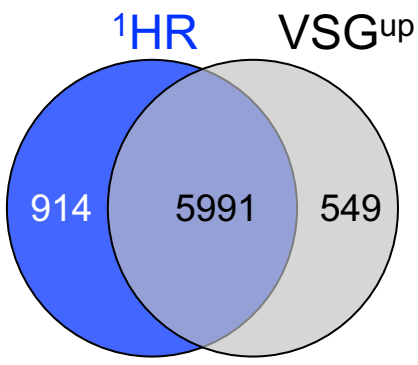

D

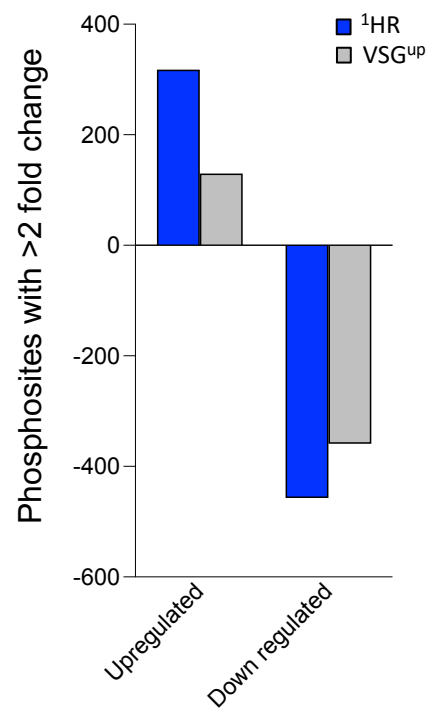
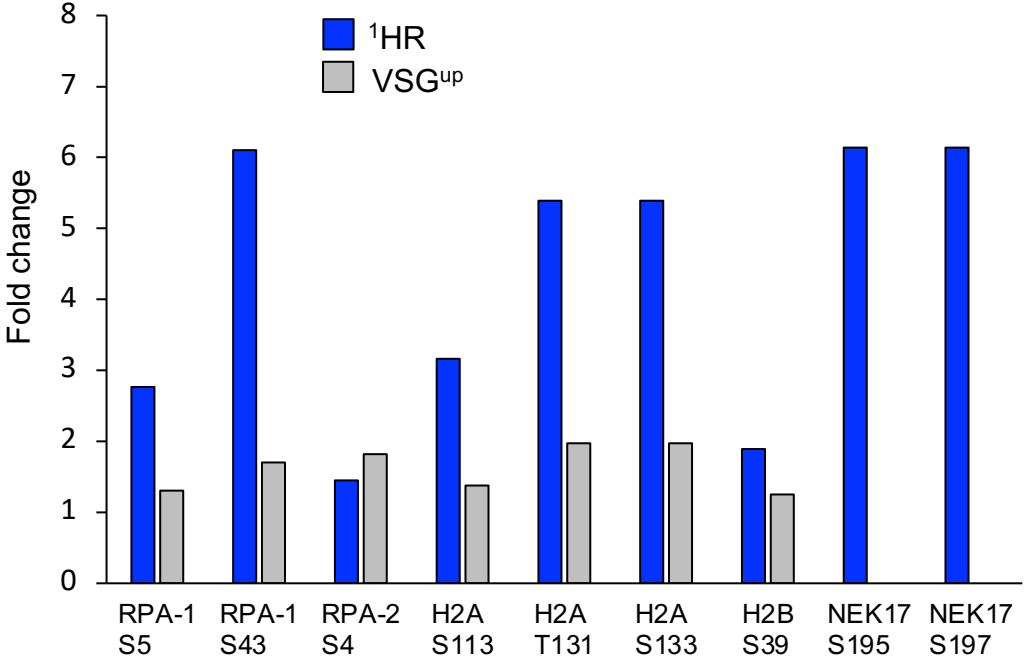
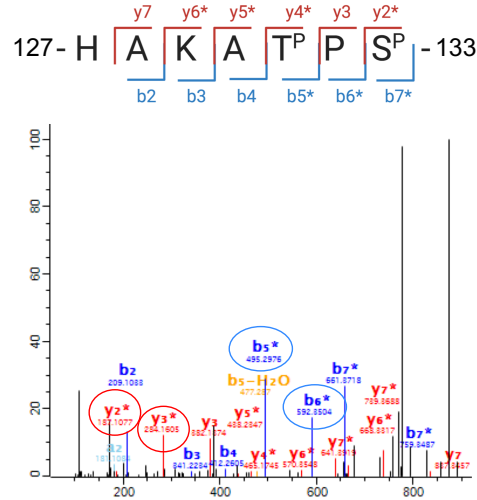

Figure 3. Phosphorylation of DNA damage proteins

A



B



C

<i>T. brucei</i>	110	VMP <b>*</b> SLNKALAKKQKS	SGKHAKATPSV	134
<i>T. congolense</i>	110	VMP <b>*</b> SLNKALAKKQKS	SGKRAKATPSV	134
<i>T. vivax</i>	111	VMP <b>*</b> SLNRALAKKQKS	SPQARGT <b>*</b> PSA	134
<i>L. braziliensis</i>	109	VVPSL <b>*</b> IRAKITKKK	-GGKSKATPSA	132
<i>L. amazonensis</i>	109	VVPSVSKAMSKK	-KGGKLLKATPSA	132
<i>L. donovani</i>	109	VVPNISKAMAKK	-KGGKCKATPSA	132

Figure 4.

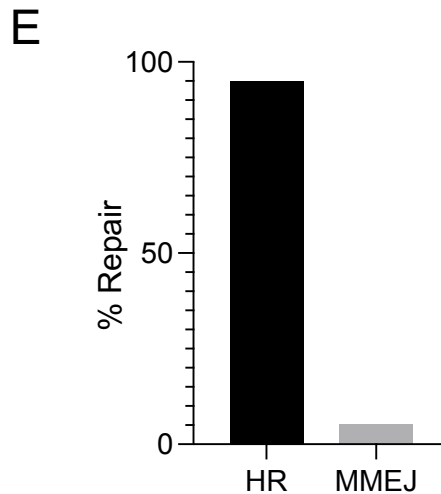
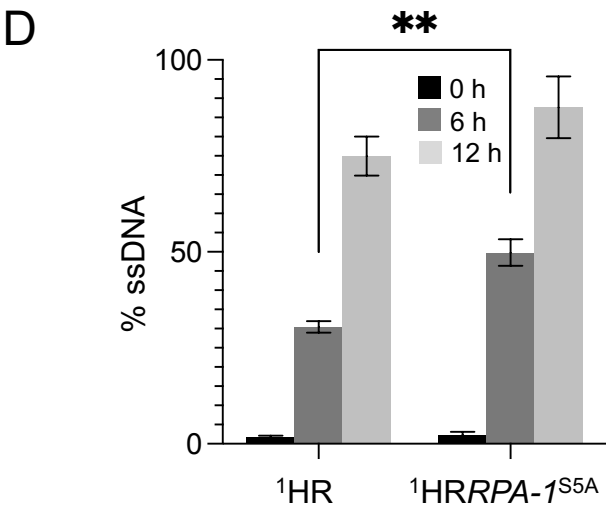
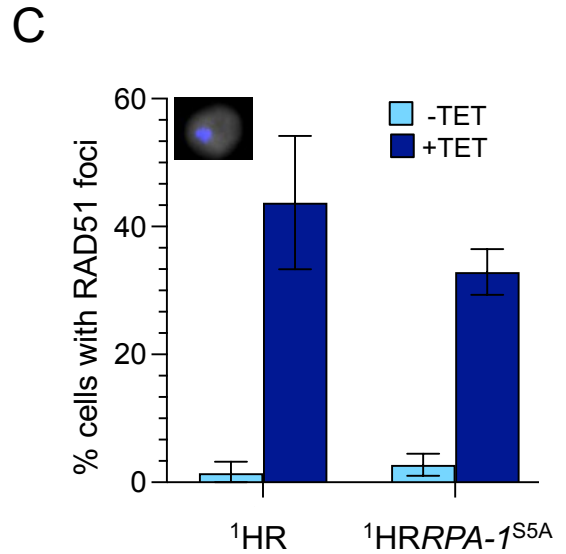
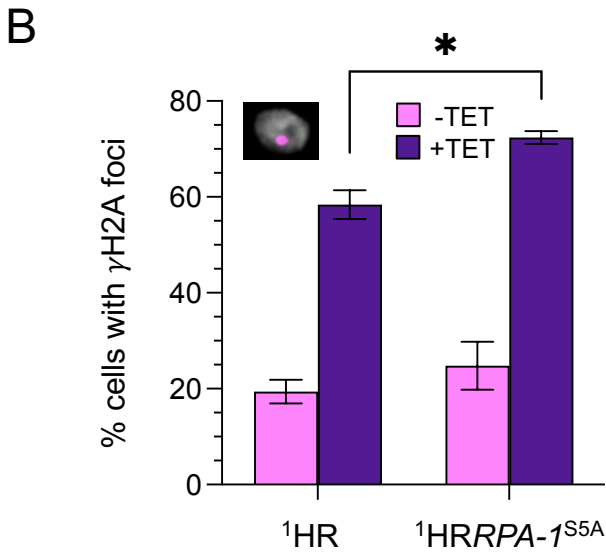
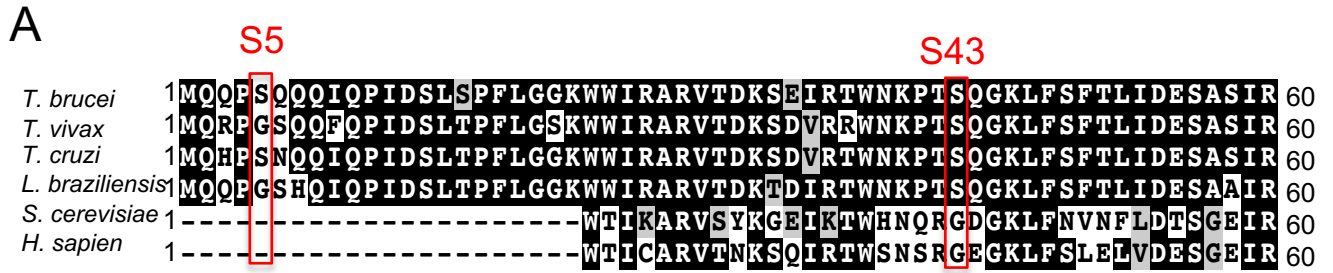

Figure 5.

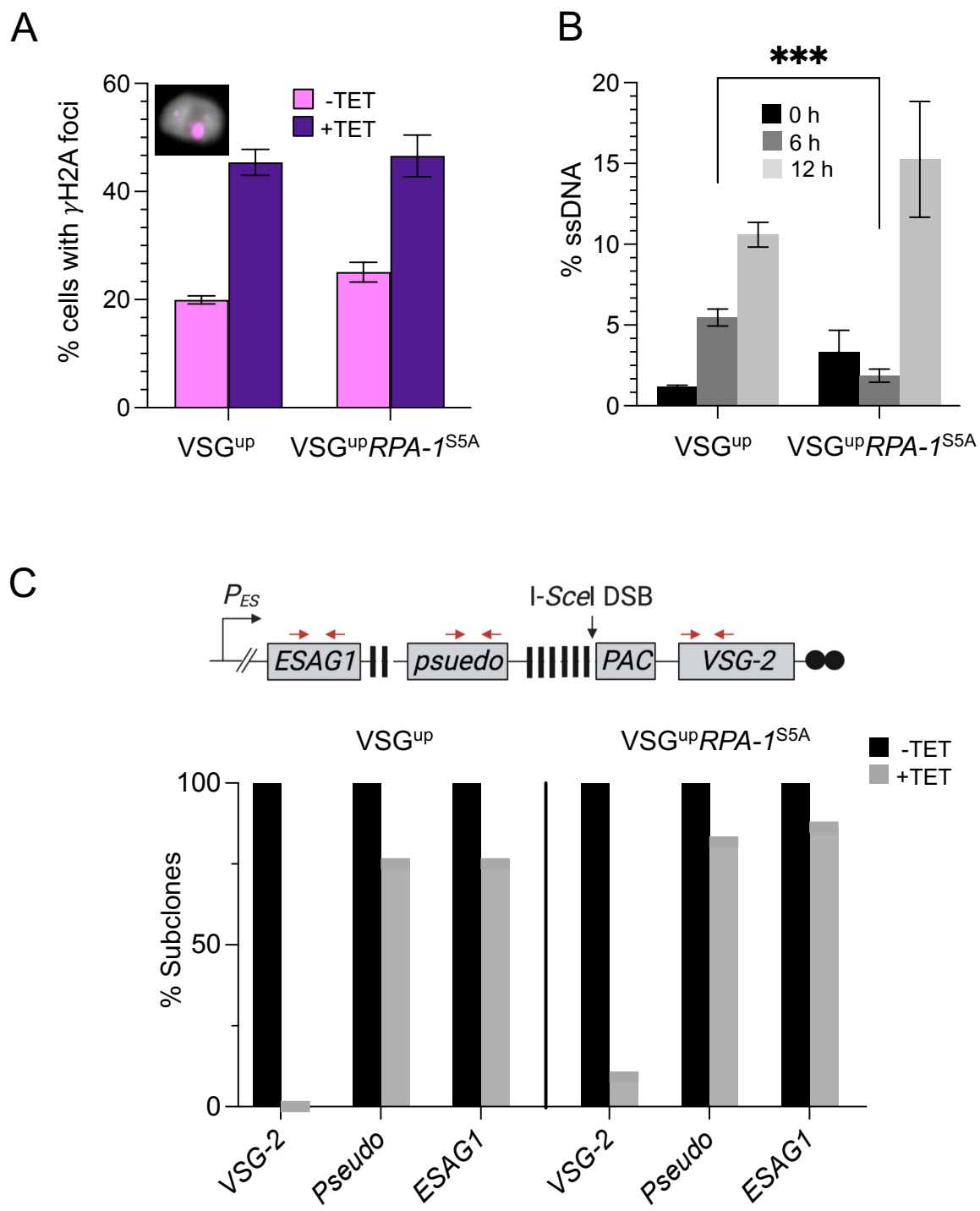
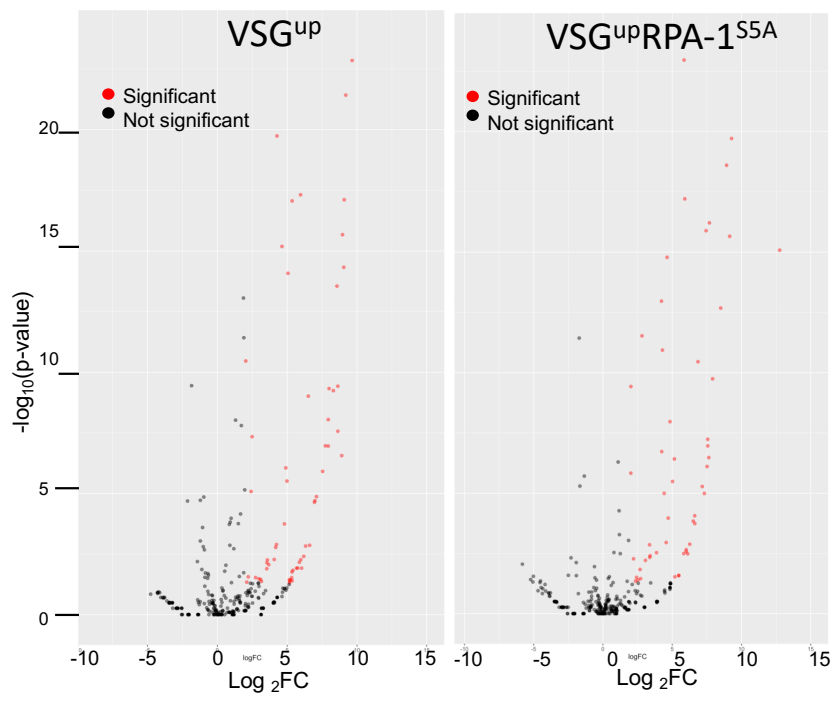
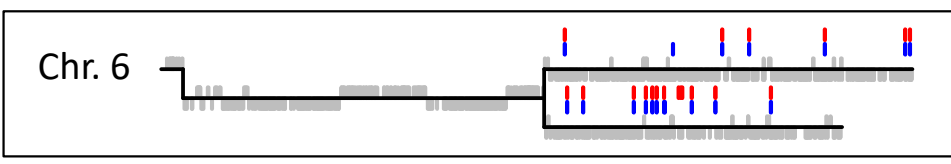
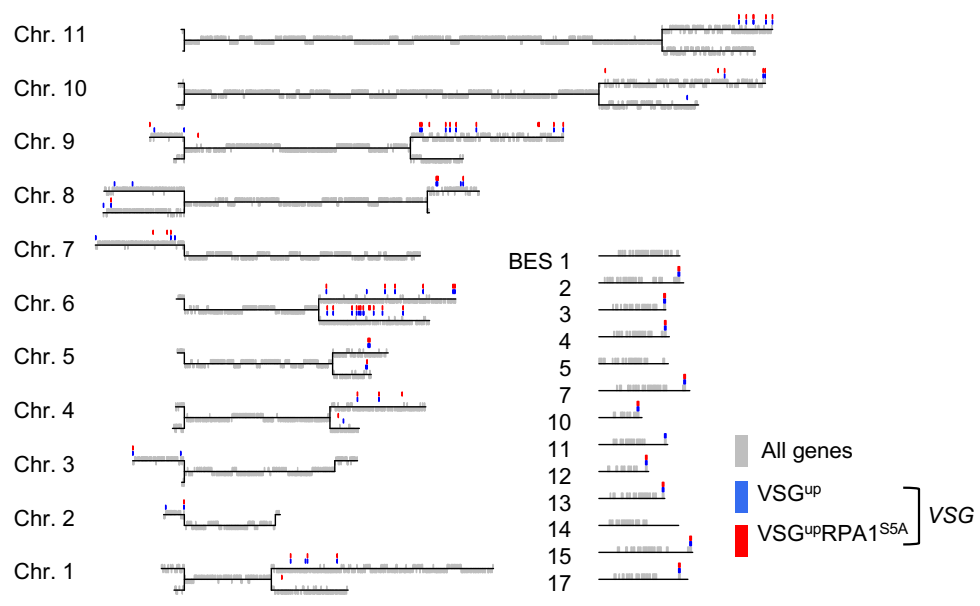

Figure 6.

A



B





# Supplementary Figures

Figure S1

(A)

Cell line	Number of peptides	Number of 'heavy' labelled peptides	Incorporation
INT	12,006	11,217	93,3%
VSG <sup>up</sup>	17,163	16,500	96,1%

(B)

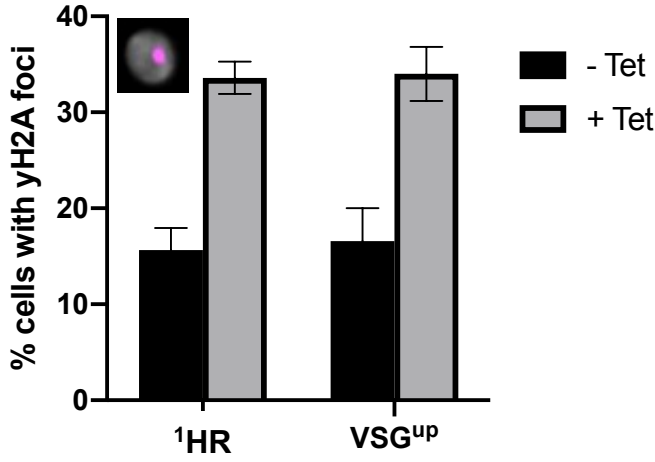
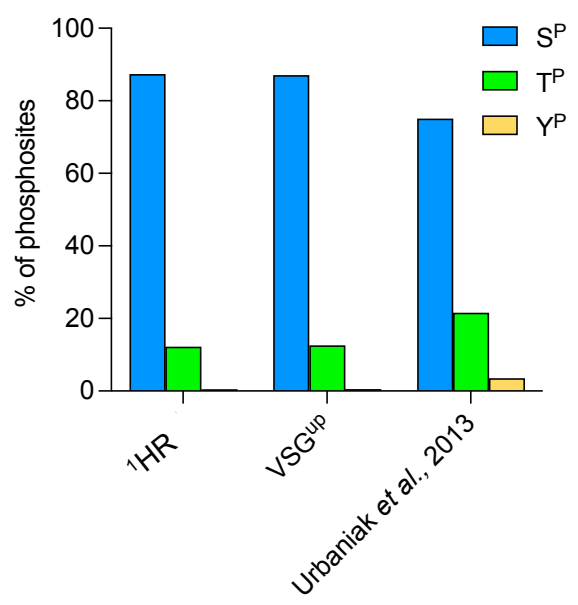

Figure S2.

A



B

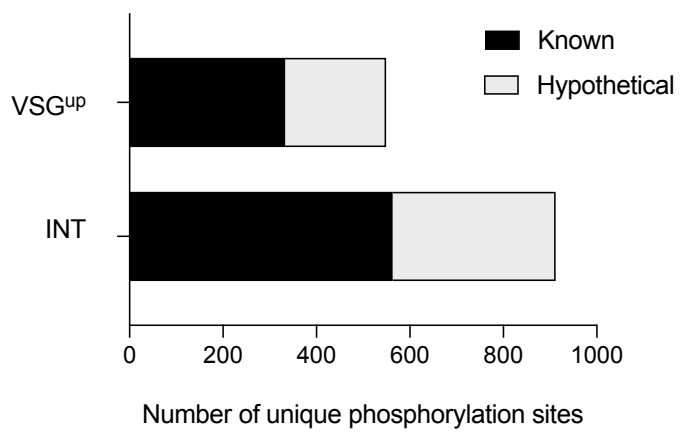
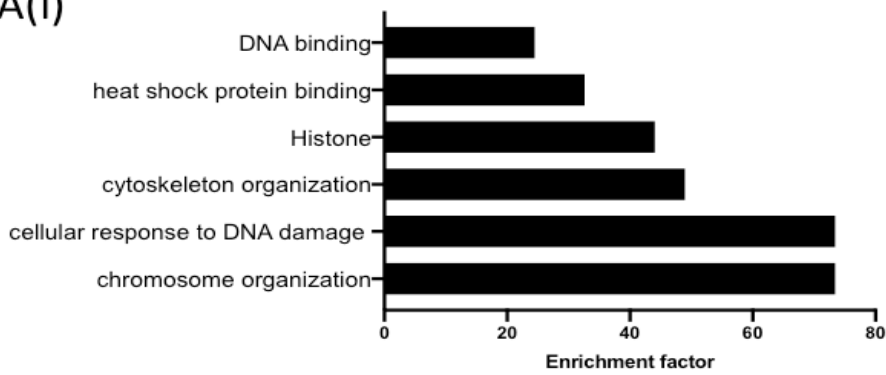
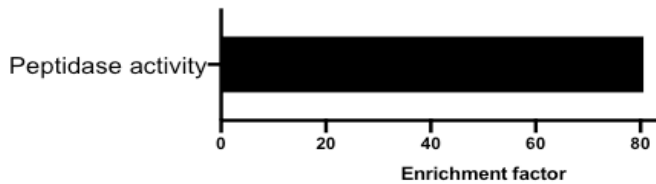

Figure S3.

A(i)



(ii)



(B)(i)

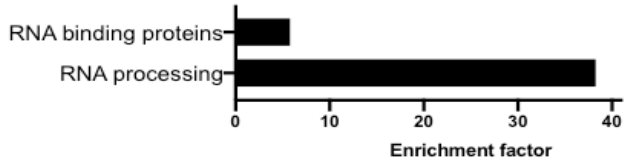

(ii)

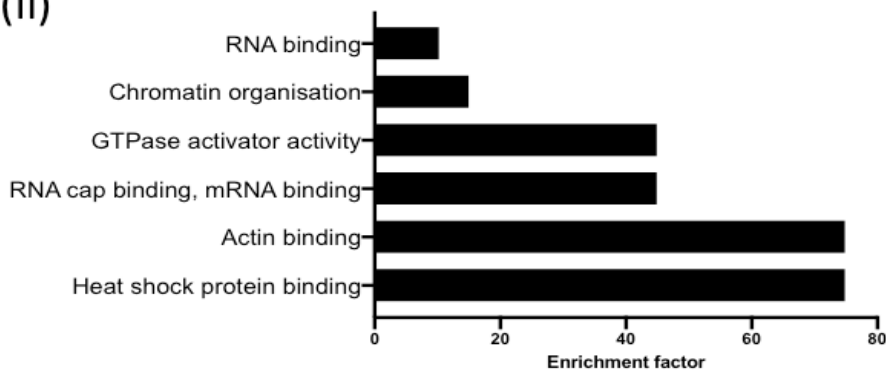
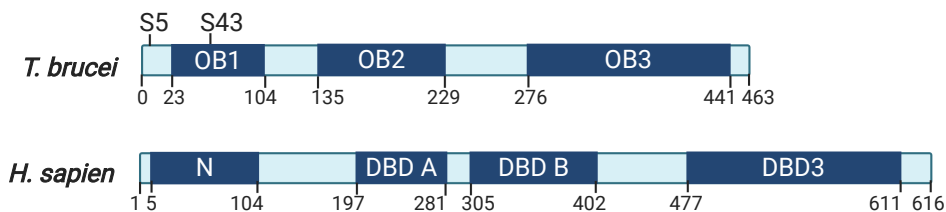
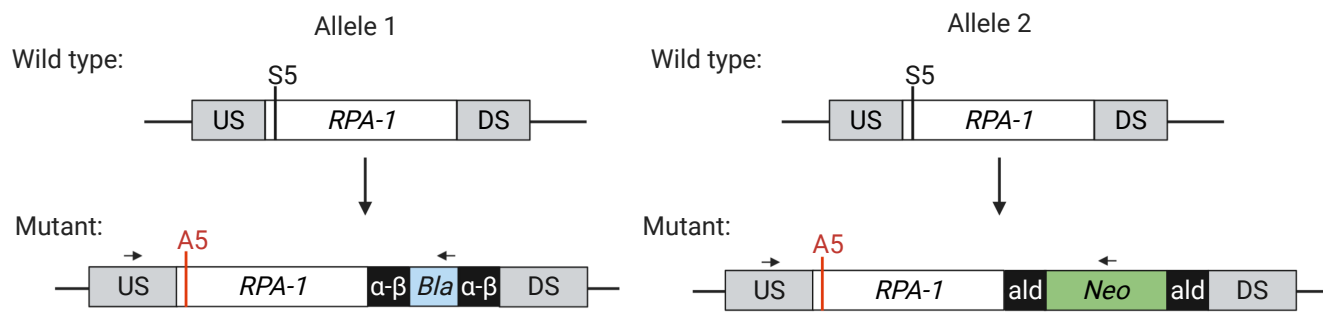

Figure S4.

A



B



C

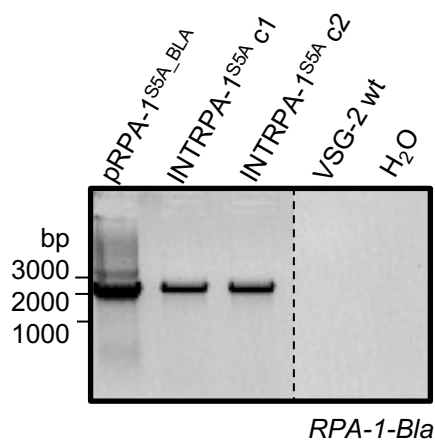

D

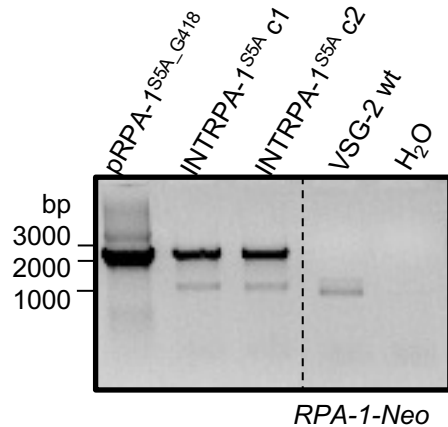

E

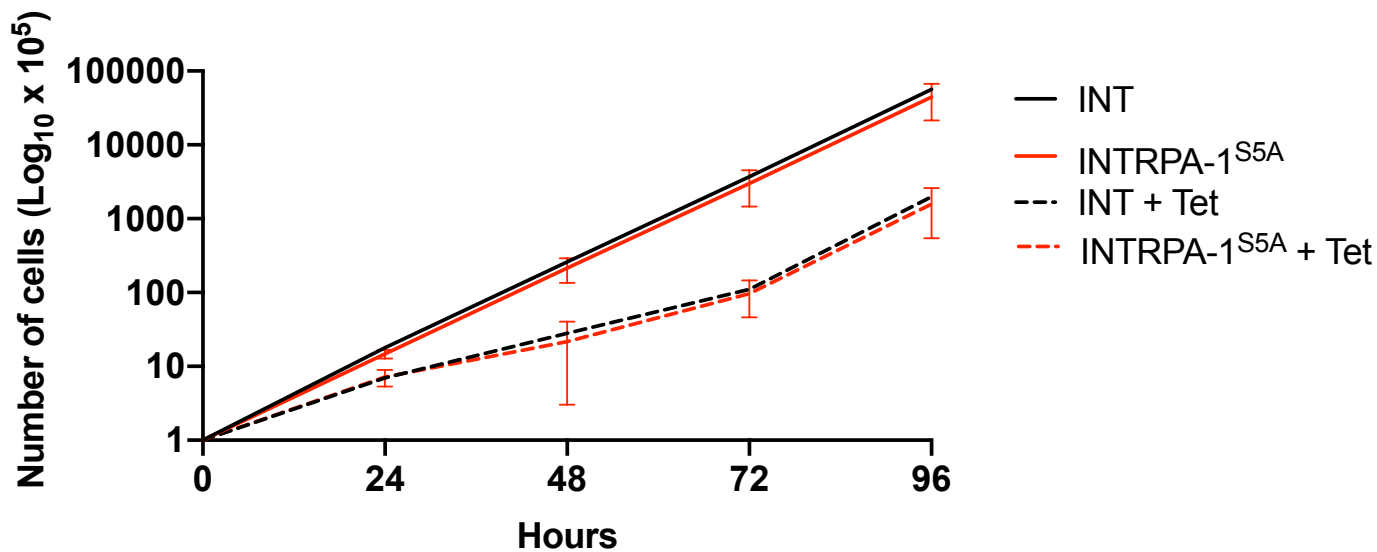

Figure S5.

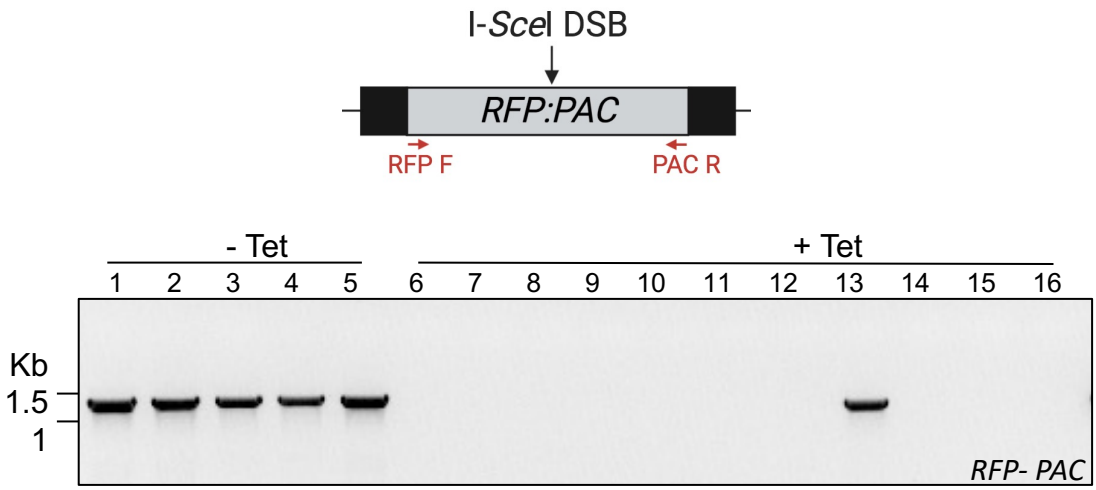
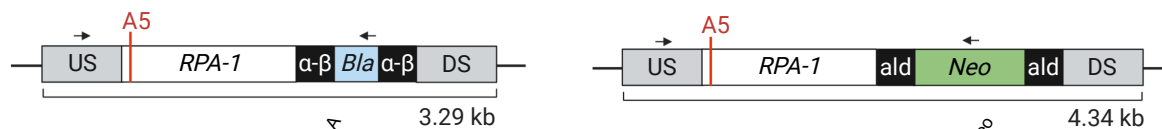
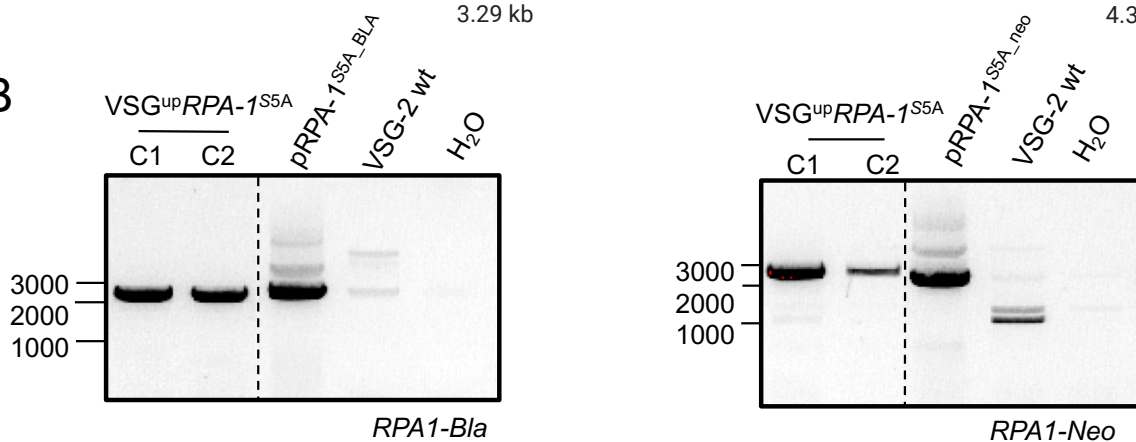

Figure S6.

A



B



C

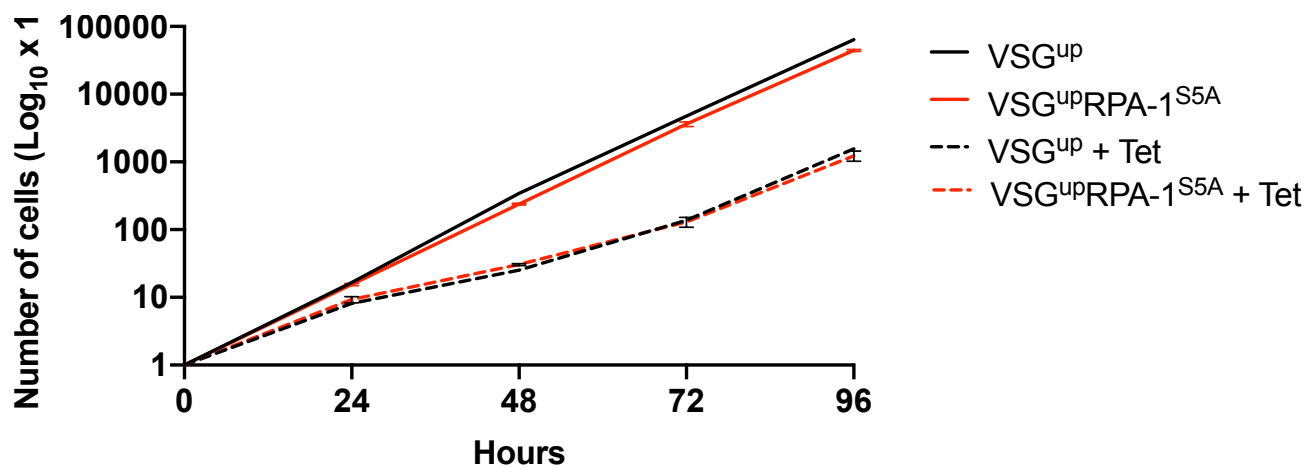

D

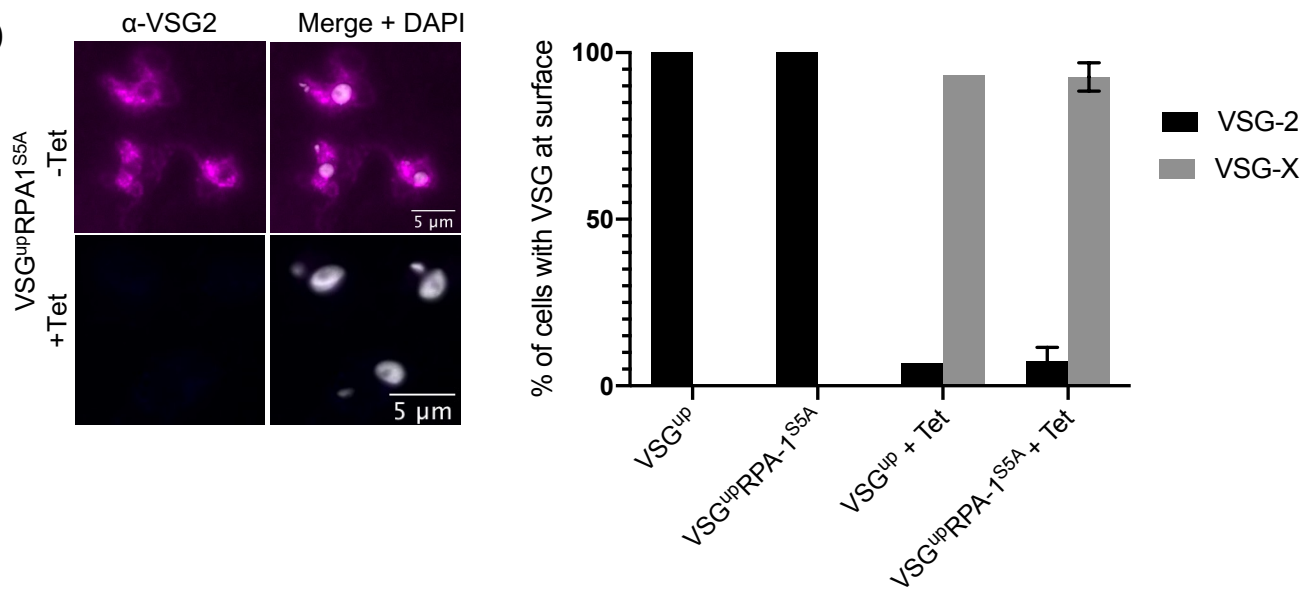
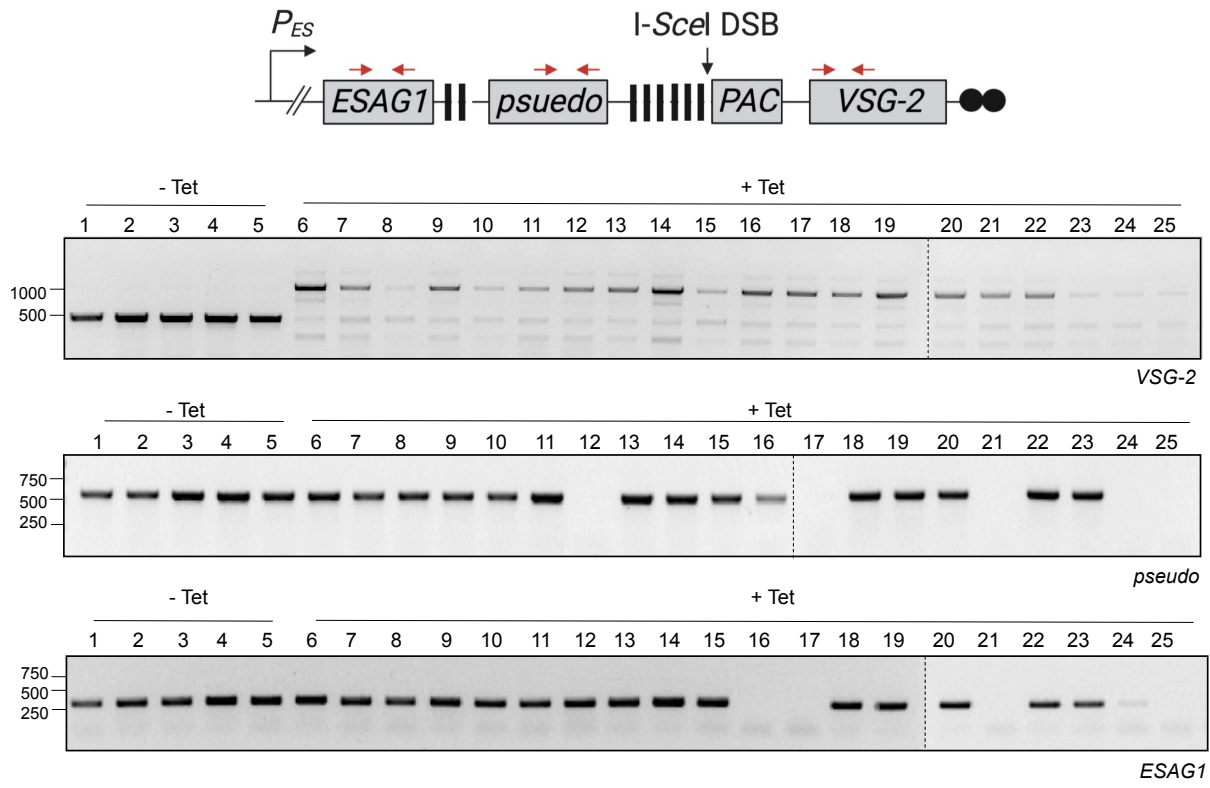

Figure S7.

A



B

