



HAL
open science

GarA is an essential regulator of metabolism in *Mycobacterium tuberculosis*

Marcello Ventura, Barbara Rieck, Francesca Boldrin, Giulia Degiacomi, Marco Bellinzoni, Nathalie Barilone, Faisal Alzaidi, Pedro Alzari, Riccardo Manganelli, Helen O'Hare

► **To cite this version:**

Marcello Ventura, Barbara Rieck, Francesca Boldrin, Giulia Degiacomi, Marco Bellinzoni, et al.. GarA is an essential regulator of metabolism in *Mycobacterium tuberculosis*. *Molecular Microbiology*, 2013, 90 (2), pp.356-66. 10.1111/mmi.12368 . pasteur-03096131

HAL Id: pasteur-03096131

<https://pasteur.hal.science/pasteur-03096131>

Submitted on 4 Jan 2021

HAL is a multi-disciplinary open access archive for the deposit and dissemination of scientific research documents, whether they are published or not. The documents may come from teaching and research institutions in France or abroad, or from public or private research centers.

L'archive ouverte pluridisciplinaire **HAL**, est destinée au dépôt et à la diffusion de documents scientifiques de niveau recherche, publiés ou non, émanant des établissements d'enseignement et de recherche français ou étrangers, des laboratoires publics ou privés.



Distributed under a Creative Commons Attribution 4.0 International License

GarA is an essential regulator of metabolism in *Mycobacterium tuberculosis*

Marcello Ventura,^{1†} Barbara Rieck,^{2†}
Francesca Boldrin,¹ Giulia Degiacomi,¹
Marco Bellinzoni,⁴ Nathalie Barilone,⁴ Faisal Alzaidi,²
Pedro M. Alzari,⁴ Riccardo Manganelli^{1**} and
Helen M. O'Hare^{2,3*}

¹Department of Molecular Medicine, University of Padua, Via Gabelli 63, Padova, Italy.

²Department of Infection, Immunity and Inflammation and ³Department of Biochemistry, University of Leicester, Leicester LE1 9HN, UK.

⁴Institut Pasteur, Unité de Microbiologie Structurale and CNRS-UMR3528, 75015 Paris, France.

Summary

Alpha-ketoglutarate is a key metabolic intermediate at the crossroads of carbon and nitrogen metabolism, whose fate is tightly regulated. In mycobacteria the protein GarA regulates the tricarboxylic acid cycle and glutamate synthesis by direct binding and regulation of three enzymes that use α -ketoglutarate. GarA, in turn, is thought to be regulated via phosphorylation by protein kinase G and other kinases. We have investigated the requirement for GarA for metabolic regulation during growth *in vitro* and in macrophages. GarA was found to be essential to *Mycobacterium tuberculosis*, but dispensable in non-pathogenic *Mycobacterium smegmatis*. Disruption of *garA* caused a distinctive, nutrient-dependent phenotype, fitting with its proposed role in regulating glutamate metabolism. The data underline the importance of the TCA cycle and the balance with glutamate synthesis in *M. tuberculosis* and reveal vulnerability to disruption of these pathways.

Introduction

Mycobacterium tuberculosis is an obligate pathogen that multiplies inside macrophages and granulomas, possibly using host fatty acids and cholesterol as carbon sources (Lee *et al.*, 2013). *In vitro* *M. tuberculosis* is able to utilize diverse carbon sources, since it possesses complete path-

ways for glycolysis, the tricarboxylic acid (TCA) cycle, the pentose phosphate pathway, glyoxylate cycle and methyl citrate cycle (Beste *et al.*, 2007). Efficient carbon metabolism is required for growth and persistence *in vivo*, since disruption of gluconeogenesis, the glyoxylate cycle and the methyl citrate cycle have each been found to reduce the virulence of *M. tuberculosis* in mice (McKinney *et al.*, 2000; Munoz-Elias *et al.*, 2006; Marrero *et al.*, 2010).

The TCA cycle is the major energy-generating pathway in aerobic organisms, with the α -ketoglutarate dehydrogenase complex (KDH) being a major point of control of flux through the cycle (Bunik and Fernie, 2009). In most aerobic organisms KDH is regulated at the level of gene expression and also by key metabolites that are allosteric activators or inhibitors (Bunik and Fernie, 2009). The KDH of *M. tuberculosis* is encoded by Rv1248c (α -ketoglutarate decarboxylase, Kgd), Rv2215 [dihydrolipoamide acyltransferase, DlaT (Tian *et al.*, 2005)] and Rv0462 [dihydrolipoamide dehydrogenase, Lpd (Argyrou and Blanchard, 2001)] (Wagner *et al.*, 2011). The Kgd subunit of *M. tuberculosis*, like that of *Corynebacterium glutamicum* and the majority of other Actinobacteria, has an additional acyltransferase domain, enabling the same DlaT subunit to function in both KDH and the pyruvate dehydrogenase complex (Niebisch *et al.*, 2006; Wagner *et al.*, 2011). The KDH complex appears to be a key point of control in *M. tuberculosis*. In addition to allosteric activation by acetyl-coenzyme A, *M. tuberculosis* KDH is also regulated by binding to an inhibitor protein called GarA (O'Hare *et al.*, 2008; Wagner *et al.*, 2011). This unconventional regulator was first identified in *C. glutamicum* (Niebisch *et al.*, 2006) and may operate in many other organisms since GarA homologues are widespread in the Actinobacteria.

GarA is a small protein consisting of a forkhead associated (FHA) domain with N- and C-terminal extensions. The typical function of an FHA domain is protein-protein interaction mediated by specific recognition of phosphorylated threonine residues (Durocher *et al.*, 1999), and indeed when GarA is phosphorylated at its N-terminus the FHA domain is able to bind to phosphothreonine within the N-terminus in an auto-recognition event (Barthe *et al.*, 2009; England *et al.*, 2009; Nott *et al.*, 2009) that blocks binding to KDH, relieving inhibition. Thus the GarA-KDH complex is the endpoint of a kinase signalling pathway to control metabolism.

Accepted 15 August, 2013. For correspondence. *E-mail hmo7@le.ac.uk; Tel. (+44) 116252 2947; Fax (+44) 116252 5030; **E-mail riccardo.manganelli@unipd.it; Tel. (+39) 49 827 2366; Fax (+39) 49 827 2355. †These authors contributed equally to this work.

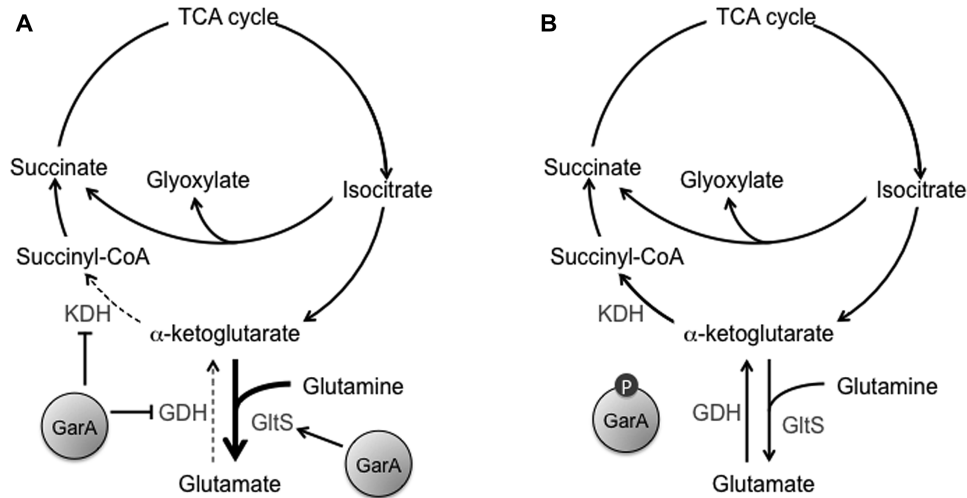

Fig. 1. The current model of the regulation of the tricarboxylic acid cycle and glutamate synthesis by GarA.

A. When GarA is unphosphorylated it binds and inhibits the α -ketoglutarate dehydrogenase (KDH) complex and glutamate dehydrogenase (GDH). Unphosphorylated GarA binds and activates glutamate synthase (GltS, also known as GOGAT). The net effect is inhibition of the TCA cycle and promotion of glutamate synthesis.

B. When protein kinase G phosphorylates GarA it is no longer able to bind any of its enzyme partners. Inhibition of the TCA cycle is relieved.

The substrate of KDH, α -ketoglutarate, lies at the crossroads of carbon and nitrogen metabolism, as it is also a substrate for glutamate synthesis either by transamination or using ammonia. In addition to regulation of the TCA cycle, GarA regulates the balance between the TCA cycle and glutamate metabolism by inhibiting glutamate dehydrogenase (GDH), involved in glutamate breakdown, and activating glutamate synthase (GltS), involved in glutamate synthesis (Nott *et al.*, 2009). The net result is that unphosphorylated GarA is predicted to promote glutamate synthesis (Fig. 1).

Glutamate is the major amino group donor in anabolism and one of the most abundant cellular metabolites. As such, glutamate biosynthesis and degradation are subject to complex regulation. In bacteria glutamate is synthesized by glutamate dehydrogenase or, during nitrogen limitation, by the co-ordinated activity of glutamate synthase and ATP-dependent glutamine synthetase. This latter pathway is predicted to be the main route of glutamate synthesis in *M. tuberculosis*, since the only GDH encoded by the genome is predicted to be NADH-dependent and catabolic. The genome of *M. smegmatis*, by contrast, encodes two additional predicted NADPH-dependent anabolic GDH enzymes.

Regulation of nitrogen metabolism has been reviewed for Gram-positive *Bacillus subtilis* (Gunka and Commichau, 2012) as well as the Actinomycetes *C. glutamicum* (Burkovski, 2007) and *Streptomyces coelicolor* (Reuther and Wohlleben, 2007). In these organisms important control mechanisms include global regulators of transcription as well as post-translational control of enzyme activities, with α -ketoglutarate, glutamine and ATP serving

as markers for cellular nitrogen and carbon limitation or sufficiency. However, the mechanisms of control are distinctive in the different organisms. In *M. smegmatis* GlnR is thought to be the global nitrogen response regulator (Jenkins *et al.*, 2013). The finding that GarA binds *in vitro* to GDH and GltS suggests that it could be an important player in nitrogen regulation in the mycobacteria and potentially in other Actinobacteria (O'Hare *et al.*, 2008; Nott *et al.*, 2009).

To date GarA has been studied using recombinant proteins but there was only indirect evidence for the impact of this regulation on mycobacterial cells, coming from over-expression of GarA (Belanger and Hatfull, 1999; O'Hare *et al.*, 2008) and disruption of the kinase that phosphorylates GarA, protein kinase G (PknG) (Cowley *et al.*, 2004). More recently, genome-wide transposon mutagenesis predicted that *garA* could be essential in *M. tuberculosis* (Griffin *et al.*, 2011). The position of *garA* immediately upstream of a predicted cotranscribed essential gene might cloud interpretation of the results, although the transposon in question is not known to cause polar effects (Sasseti *et al.*, 2003). Here we used targeted gene disruption, phenotypic profiling and site-directed mutagenesis to address the physiological function of GarA in *M. smegmatis* and *M. tuberculosis*.

Results

Deletion of garA in M. smegmatis leads to a nutrient-dependent growth defect

To assess whether metabolic regulation by GarA is required for growth we attempted to construct in-frame,

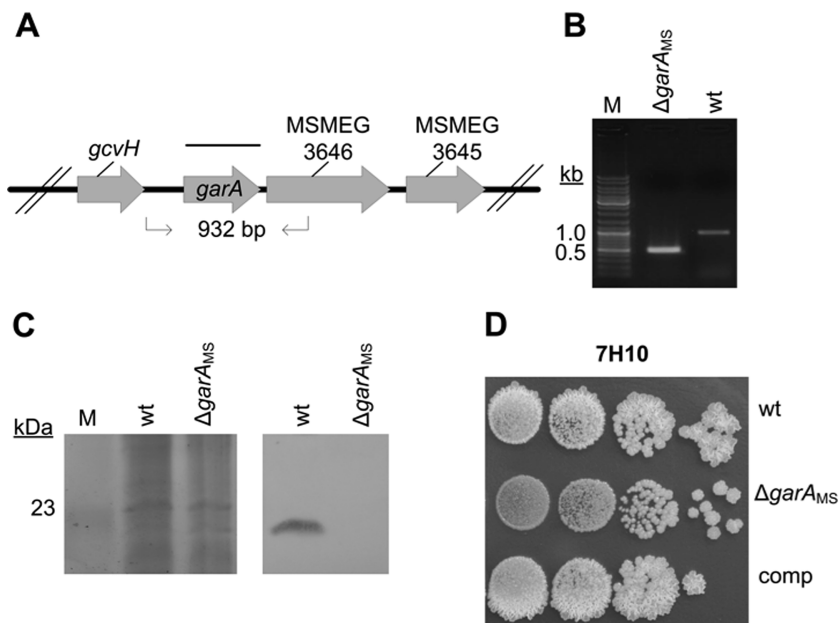

Fig. 2. Disruption of *garA* in *M. smegmatis* leads to slow growth and smooth colonies. A. Chromosomal location of *garA* in *M. smegmatis* mc²155. The black line above *garA* indicates the region deleted in Δ *garA*_{MS} and arrows below illustrate the sites of primer annealing for PCR to confirm gene disruption. B. PCR amplification of *garA* from wild type *M. smegmatis* mc²155 (wt, 932 bp) and Δ *garA*_{MS} (491 bp) confirm gene deletion. M, molecular weight markers. C. Confirmation of gene disruption by Western blotting of cell lysate from *M. smegmatis* mc²155 (wt) and Δ *garA*_{MS} using anti-GarA antibody. The left hand panel shows a Coomassie stained SDS-PAGE demonstrating equal loading. M, molecular weight marker. The right hand panel shows the Western blot. The expected molecular weight of GarA is 16.6 kDa. D. Δ *garA*_{MS} grows more slowly and has smoother colonies than *M. smegmatis* mc²155. Colonies were grown on Middlebrook 7H10 agar with ADN.

unmarked deletion mutants of *garA* (Rv1827 and MSMEG_3647) in *M. tuberculosis* H37Rv and *M. smegmatis*, but were only able to isolate a deletion mutant of *M. smegmatis*, which we termed Δ *garA*_{MS} (Fig. 2). In both organisms the gene encoding GarA is located at the start of a putative operon containing a conserved putative transcriptional regulator and a conserved hypothetical protein (Fig. 2A). The *garA* deletion in Δ *garA*_{MS} was confirmed by PCR and Western blotting (Fig. 2B and C). Colonies grew slightly slower than those of the parent strain, and had a smoother appearance (Fig. 2D).

The optimal carbon and nitrogen sources utilized by *M. tuberculosis* are glycerol and asparagine, as used in Sauton's medium (Lyon *et al.*, 1974), or glucose, glycerol, glutamate and ammonia as used in Middlebrook 7H9 medium (Middlebrook *et al.*, 1954). However, *M. tuberculosis* and *M. smegmatis* are metabolically versatile and able to utilize a large variety of carbon and nitrogen sources. Since GarA is thought to be a metabolic regulator, we hypothesized that deletion of *garA* would affect the ability of *M. smegmatis* to utilize different carbon and nitrogen sources. We measured the growth of Δ *garA*_{MS} in modified Sauton's medium using ammonium chloride as the nitrogen source and testing single variable sources of carbon. Deletion of *garA* reduced the growth rate and maximal optical density for all carbon sources tested individually (Fig. 3) and these defects were partially complemented by the introduction of plasmid-borne *garA*. Using substrates that enter glycolysis (glucose and glycerol), Δ *garA*_{MS} grew at almost the same rate as the wild type strain, but using substrates that enter the TCA cycle (acetate, propionate and succinate) Δ *garA*_{MS} showed little or no growth (Fig. 3).

Growth of Δ *garA*_{MS} was tested using a variety of nitrogen sources, and the growth defect was most pronounced when ammonium chloride was supplied (Fig. 4A and B). To investigate whether the phenotype of Δ *garA*_{MS} was simply due to a defect in the ability to assimilate inorganic ammonia/ammonium salts, we also tested the ability of Δ *garA*_{MS} to grow using asparagine plus acetate or propionate (Fig. 4C and D). In these conditions Δ *garA*_{MS} was able to grow but had a pronounced growth defect compared with the parent strain, indicating that deletion of *garA* affects the use of both carbon and nitrogen sources.

Since GarA may regulate ammonia metabolism by inhibiting glutamate dehydrogenase, we wanted to test whether the poor growth of Δ *garA*_{MS} on ammonia could be due to toxicity of ammonia, however this strain was not inhibited by the addition of ammonium chloride (30 mM) to standard Sauton's or Middlebrook 7H9 medium (not shown).

Similarly, growth on propionate is known to intoxicate mutants of *M. smegmatis* and *M. tuberculosis* deficient in the methyl citrate cycle as these strains accumulate toxic levels of propionyl-CoA (Gould *et al.*, 2006; Upton and McKinney, 2007). To test whether the growth defects of Δ *garA*_{MS} are due to toxic accumulation of metabolites, we measured growth in media supplemented sequentially with TCA cycle intermediates or amino acids. None of the tested supplements reduced growth, so there was no evidence of intoxication, but glutamate, glutamine and asparagine preferentially stimulated the growth of Δ *garA*_{MS} to wild type-like levels, suggesting that Δ *garA*_{MS} may be deficient in these metabolites. In contrast supplementation with succinate and other TCA cycle intermediates led to no stimulation of Δ *garA*_{MS} (Figs 5 and S1).

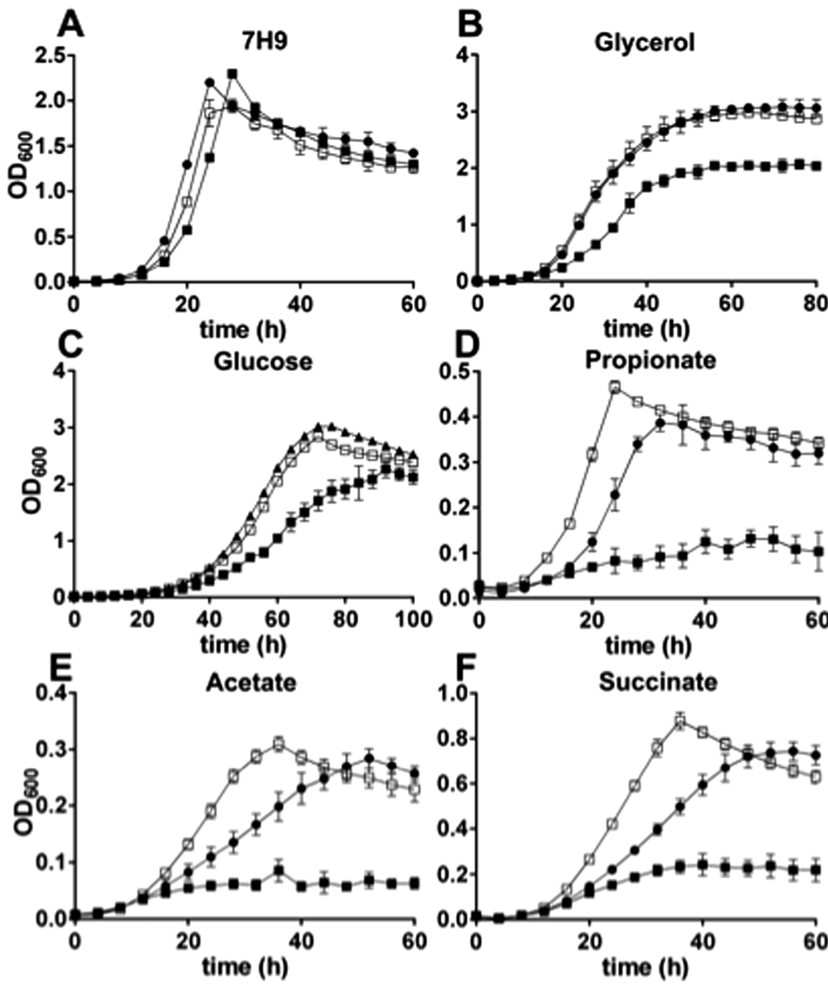

Fig. 3. Deletion of *garA* prevents utilization of some carbon sources. Growth curves of *M. smegmatis* mc²155 (□), Δ gar_{AMS} (■), and a complemented strain (Δ gar_{AMS} carrying pRBexint-*garA*: ●) in Middlebrook 7H9 medium with ADN and Tween-80 (A) or modified Sauton's medium containing 10 mM ammonium chloride as the sole nitrogen source and 0.05% tyloxapol to disperse growth (B–F). The following sole carbon sources were used: B. glycerol 1%; C. glucose 1%; D. sodium propionate 10 mM; E. sodium acetate 10 mM; F. sodium succinate 10 mM. Error bars represent standard deviation of five replicates and each graph is representative of at least three independent experiments.

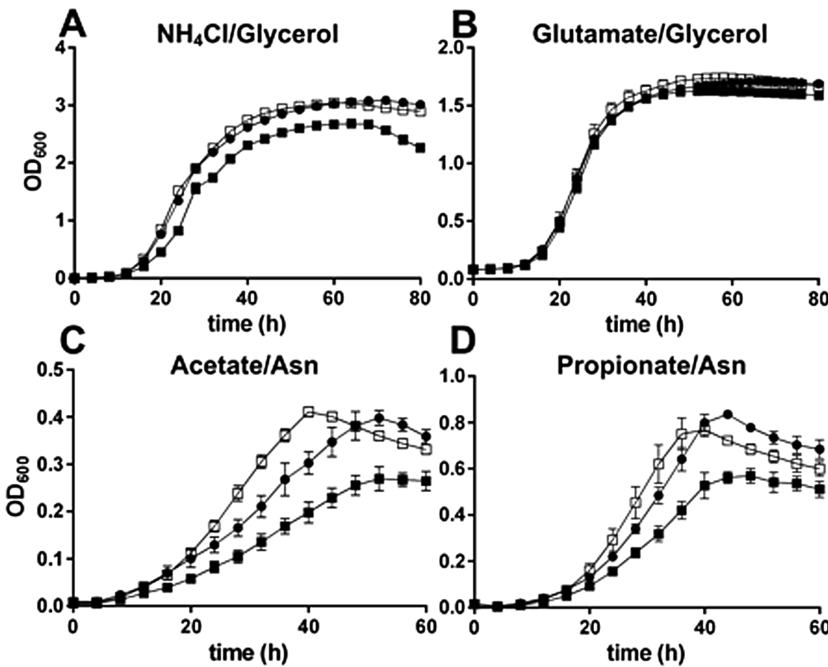

Fig. 4. The growth defect of Δ gar_{AMS} is dependent on the nitrogen and carbon sources. Growth curves of *M. smegmatis* mc²155 (□), Δ gar_{AMS} (■), and a complemented strain (Δ gar_{AMS} carrying pRBexint-GarA: ●) in modified Sauton's medium. A. 1% glycerol and 10 mM ammonium chloride are the sole carbon and nitrogen sources, Tween-80 prevents clumping. B. 1% glycerol and 10 mM glutamate are the sole carbon and nitrogen sources, Tween-80 prevents clumping. C. 10 mM sodium acetate and 3 mM asparagine are the sole carbon and nitrogen sources, tyloxapol prevents clumping. D. 10 mM sodium propionate and 3 mM asparagine are the sole carbon and nitrogen sources, tyloxapol prevents clumping. Error bars represent standard deviation of five replicates and each graph is representative of at least three independent experiments.

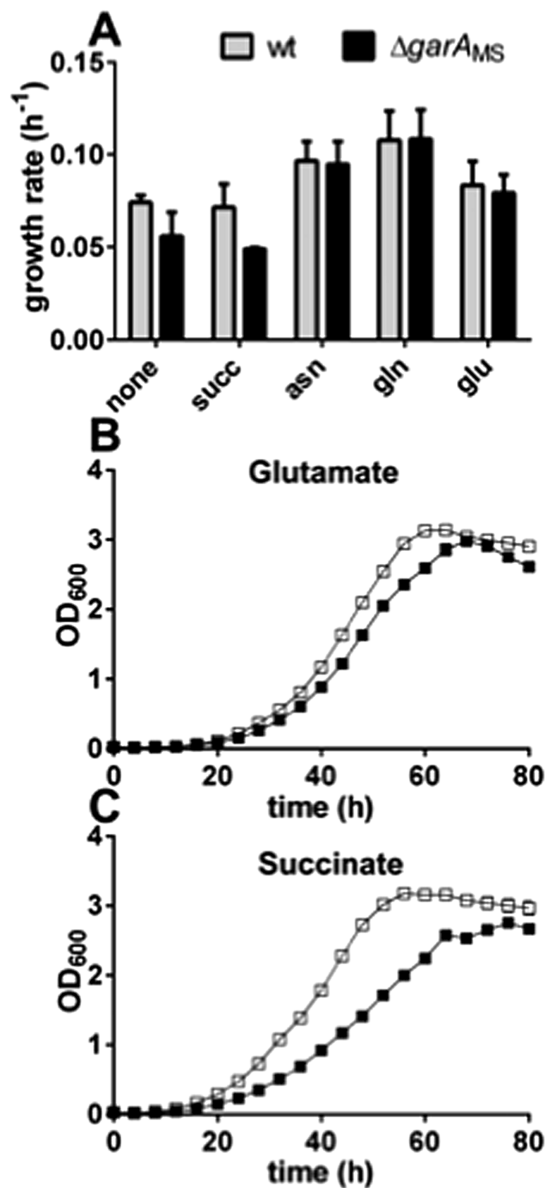

Fig. 5. The growth defect of $\Delta garA_{MS}$ is due to nutrient deficiency and can be restored by appropriate supplements.

A. The growth rate of *M. smegmatis* mc²155 and $\Delta garA_{MS}$ was calculated using optical density (A_{600}) measurements of the strains grown in modified Sauton's medium containing 1% glucose and 10 mM ammonium chloride as sole carbon and nitrogen sources, 0.05% tyloxapol to prevent clumping, plus single supplements added at 10 mM.

B. Growth of *M. smegmatis* mc²155 (□) and $\Delta garA_{MS}$ (■) in the basal medium from (A) with the addition of 10 mM glutamate.

C. Growth of *M. smegmatis* mc²155 (□) and $\Delta garA_{MS}$ (■) in the basal medium from (A) with the addition of 10 mM sodium succinate.

GarA is essential in *M. tuberculosis*

As mentioned above, attempts to delete *garA* in *M. tuberculosis* were unsuccessful, suggesting that the gene

may be essential. Therefore, the conditional knockout strain $c\Delta garA_{Mtb}$ was constructed. In this strain *garA* was subjected to an in-frame deletion allowing the expression of the downstream genes, while a copy of *garA* was integrated at the L5 *att* site under transcriptional control of a promoter repressible by anhydrotetracycline (ATc) (Fig. 6). This strain showed rapid loss of growth and viability when *garA* transcription was repressed (Fig. 7A and B) indicating that *GarA* is essential in *M. tuberculosis*.

We hypothesize that the biochemical effect of *GarA* depletion is that GDH and KDH cannot be inactivated resulting in the continued transformation of glutamate and glutamine into succinate. To confirm this hypothesis, $c\Delta garA_{Mtb}$ was grown on Middlebrook 7H10 agar plates supplemented with ATc and glutamine or glutamate. Supplementation with glutamate or glutamine (Fig. 7C), but not succinate (Fig. S2), allowed the conditional knock-down strain to grow even when *garA* transcription was repressed, confirming our hypothesis.

Since several amino acids can be converted into glutamate, one possible explanation for this phenotype is that the drainage of glutamate from the cytoplasm leads to a sink effect reducing the concentration of these amino acids to a level not compatible with growth. An alternative explanation is that the phenotype is due to depletion of glutamate and glutamine, which act as nitrogen donors. To discriminate between these two hypotheses $c\Delta garA_{Mtb}$ was grown on Middlebrook 7H10 agar plates supplemented with several amino acids at the concentration of 10 mM. The results show that only asparagine, glutamate or glutamine were able to restore the phenotype (Figs 7C and S2). The fact that the addition of asparagine, but not other amino acids which can be converted into glutamate, allowed the mutant to grow suggests that the growth inhibition does not result from amino acid drainage due to the attempt of the cell to replenish the glutamate pool. However, since the only amino acids able to restore the growth are those that can act as nitrogen donors (glutamine and glutamate directly and asparagine following release of ammonia by the asparaginase Rv1538c), the effect may be due to the deficiency of nitrogen donors.

GarA is essential for intracellular growth and survival of *M. tuberculosis*

In order to determine if *GarA* is essential also during intracellular growth, we infected THP-1-derived human macrophages with $c\Delta garA_{Mtb}$. When ATc was added to the cell culture medium, bacteria grew during the first two days, and then quickly lost viability (Fig. 8). These findings clearly show that *GarA* is essential for intracellular growth of *M. tuberculosis*.

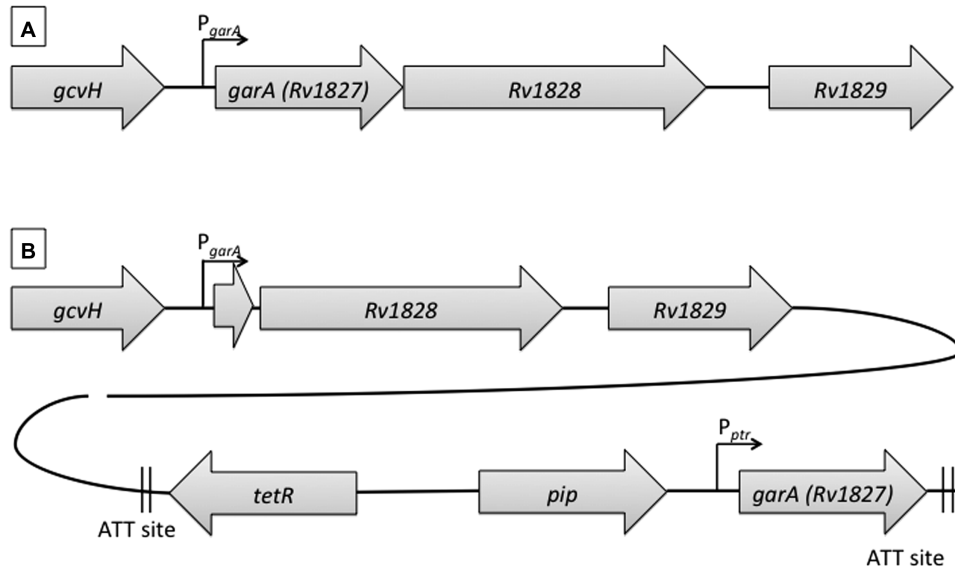

Fig. 6. The strategy used to create a conditional mutant for *garA* in *M. tuberculosis*. A. In *M. tuberculosis*, as in *M. smegmatis*, *garA* is the first gene in an operon. B. In the conditional mutant $c\Delta garA_{Mtb}$ there is an unmarked deletion of *garA*, which leaves the *garA* promoter (P_{garA}) and two downstream genes intact. The att site contains the TetR/Pip OFF repressible promoter system: *tetR* is transcribed constitutively and TetR represses *pip* transcription. When anhydrotetracycline is added it binds to TetR, allowing transcription of *pip*. Pip then prevents transcription of *garA*.

Variants of *GarA* disrupted for binding to *KDH* cannot complement the growth of *garA* knockout *M. smegmatis*

GarA binds three enzymes involved in central metabolism: *KDH*, *GDH* and *GltS*, via its *FHA* domain. Mutations in the *FHA* domain have been identified that preferentially disrupt binding to some or all three of the enzymes (Nott *et al.*,

2009). The mutation *S94A* disrupts binding to *GDH* and *GltS*, *R142A* to *KDH* and *GDH*, and *K140E* disrupts binding to all three enzymes. These variant *garA* genes were tested for their ability to complement the phenotype of $\Delta garA_{MS}$ and $c\Delta garA_{Mtb}$ (Table 1 and Fig. 9). Variant *K140E*, which is unable to bind any of the three enzymes *in vitro*, is poorly able to complement the growth of $\Delta garA_{MS}$.

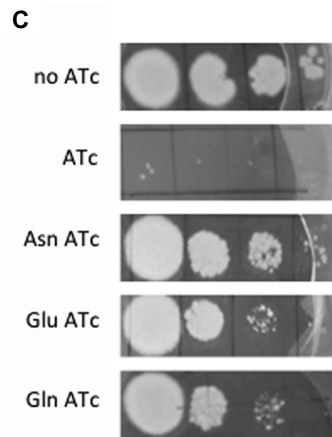
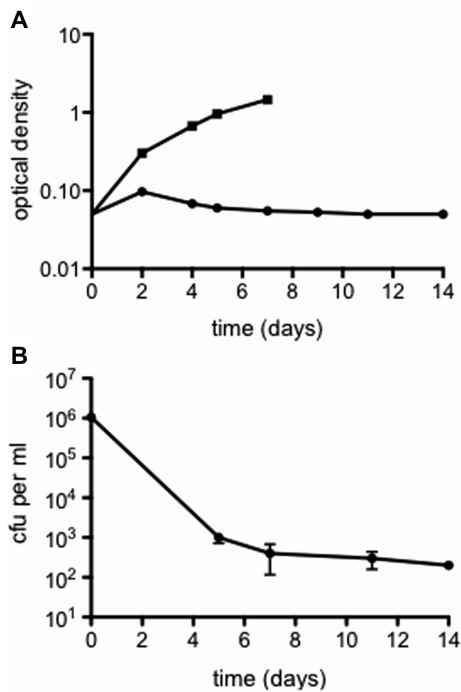

Fig. 7. *garA* is an essential gene in *M. tuberculosis*. Repression of *garA* transcription in the conditional mutant $c\Delta garA_{Mtb}$ leads to loss of growth and viability. A. Graphs show the optical density of $c\Delta garA_{Mtb}$ cultured in the presence (circles) or absence (squares) of anhydrotetracycline. B. $c\Delta garA_{Mtb}$ cultured in the presence of anhydrotetracycline was tested for viability by counting cfu on 7H10 agar. The culture on day 14 gave no colonies, meaning that there were fewer than 200 cfu ml⁻¹. Error bars show the standard deviation for duplicate measurements. Results shown are representative of two independent experiments. C. Supplementation with glutamate, glutamine or asparagine restores the growth defect of $c\Delta garA_{Mtb}$. Serial dilutions were spotted onto 7H10 plates containing zero or 500 ng ml⁻¹ anhydrotetracycline, ATc, plus specific supplements added at 10 mM. Gln, glutamine; Glu, glutamate; Asn, asparagine.

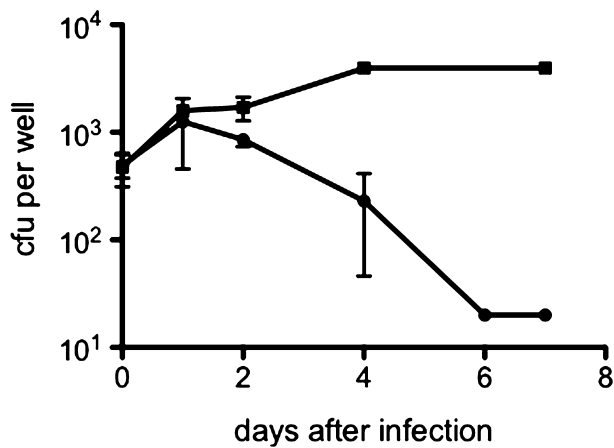

Fig. 8. *garA* is essential for growth and survival of *M. tuberculosis* in macrophages. Differentiated THP-1 cells infected with $\Delta garA_{MS}$ were incubated in the presence (circles) or absence (squares) of anhydrotetracycline then lysed and bacterial viability measured. In the presence of anhydrotetracycline macrophages yielded no colonies on days 6 and 7, indicating fewer than 200 bacilli per well. Error bars show the standard deviation for duplicate measurements. Results shown are representative of two independent experiments.

By contrast, the S94A variant, which shows reduced binding to GDH or GltS but retains binding to KDH, was able to restore growth almost as well as the wild type gene (Fig. 9). This complementation suggests that regulation of KDH, GDH and GltS is the main function of GarA and that

inhibition of KDH in particular is crucial for normal growth of *M. smegmatis*.

Discussion

We have previously proposed that GarA acts as a regulator of metabolism in mycobacteria, since recombinant GarA acts on the activities of KDH, GDH and GltS, whereas overexpression of GarA inhibits the growth of *M. smegmatis* (O'Hare *et al.*, 2008). Supporting this hypothesis we present data showing that gene disruption of *garA* leads to a specific nutrient-dependent growth defect.

Based on the phenotype of *pknG* disruption [glutamate accumulation (Cowley *et al.*, 2004)], and the enzyme-modulatory effects of recombinant GarA (O'Hare *et al.*, 2008; Nott *et al.*, 2009), we have established a model in which GarA influences the distribution of α -ketoglutarate between the TCA cycle and glutamate synthesis by inhibiting KDH, activating glutamate synthesis and inhibiting glutamate degradation (Fig. 1). This model is supported by the fact that supplementation with glutamate restores normal growth of *garA* deficient *M. smegmatis* and *M. tuberculosis* (Figs 5 and 7C). Based on these results we propose that unphosphorylated GarA promotes glutamate synthesis and PknG reduces glutamate synthesis via phosphorylation of GarA.

In contrast to the nutrient-dependent growth defect of $\Delta garA_{MS}$, *garA* knockdown in *M. tuberculosis* caused rapid

Table 1. Complementation of $\Delta garA_{MS}$ with plasmid borne *garA* variants.

GarA variant	Variant binds to:			Complementation of $\Delta garA_{MS}$	Conclusion
	KDH	GDH	GltS		
K140E	N	N	N	Poor	Enzyme regulation is important for GarA function.
R142A	N	N	Y	Intermediate	GltS activation is needed but is not sufficient for GarA function.
S94A	Y	N	N	Full	KDH inhibition is crucial for GarA function.

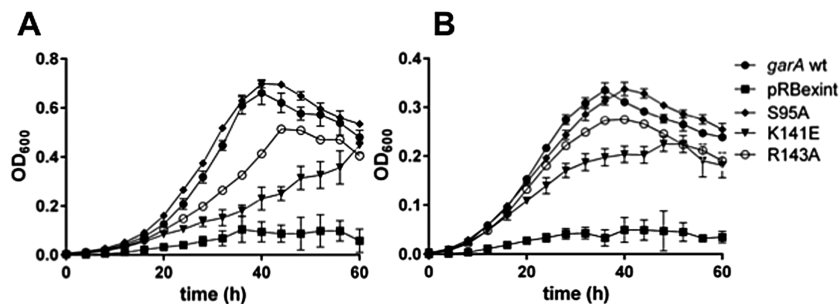

Fig. 9. Variants of GarA deficient in KDH binding are unable to complement the phenotype of $\Delta garA_{MS}$. $\Delta garA_{MS}$ carrying control plasmid (■) or plasmids bearing wild type *garA* (wt, ●) or site-directed mutants of *garA* were grown in modified Sauton's medium containing 10 mM NH_4Cl as the sole nitrogen source and either 20 M propionate (A) or 20 mM acetate (B) as the sole carbon source. Variants of *garA* carried the following single mutations: S94A (◆), K140E (▼) or R142A (○). Error bars represent standard deviation of five replicates and each graph is representative of at least three independent experiments.

loss of growth and viability, indicating that GarA regulation of glutamate synthesis plays a more important role in this organism. GarA, PknG and the enzymes they control are conserved in all members of the *M. tuberculosis* complex as well as other sequenced mycobacteria (Table S1). However, the genome of *M. smegmatis* encodes two additional GDHs not present in *M. tuberculosis*. Indeed, the predominant GDH activity in cell extracts is NADP⁺-dependent and is not regulated by GarA (29 nmol mg⁻¹ min⁻¹, data not shown). The additional capability of *M. smegmatis* to accumulate and degrade glutamate by alternative enzymes is the most likely reason for the non-essentiality of GarA in this organism.

Although GarA is essential for growth of *M. tuberculosis* in standard conditions, specific supplementation with glutamate, glutamine or asparagine could restore the ability of $\Delta garA_{Mtb}$ to grow *in vitro* (Fig. 7). The fact that $\Delta garA_{Mtb}$ could not replicate but was rapidly killed in macrophages (Fig. 8) could report on the nutritional environment inside the phagosome, seeming to indicate that intracellular *M. tuberculosis* does not experience nutritionally permissive, amino acid rich conditions, consistent with an earlier study (Tullius *et al.*, 2003). The cell culture conditions mimics the concentration of amino acids in normal human plasma, with the exception of glutamine, which is 2 mM compared with approximately 0.6 mM in plasma, and so it is tempting to speculate that GarA would also be essential for *M. tuberculosis* to cause disease in humans.

In mycobacteria GarA can bind to three different enzyme targets, whereas the homologous protein in *C. glutamicum* is only thought to regulate KDH. We have previously used site-directed mutagenesis to define the overlapping binding sites for each enzyme on the FHA domain of GarA and to produce mutant versions of GarA that are deficient in binding to one or all enzyme partners. Here we used these mutant versions of GarA to complement the growth defect of $\Delta garA_{MS}$. The data confirm that enzyme binding is necessary for GarA function and could also suggest the relative importance of regulating each individual enzyme activity. These data must be interpreted with caution since the FHA domain of GarA is also involved in binding to protein kinases and therefore these mutations may reduce the ability of the kinase to phosphorylate GarA. Nevertheless, Table 1 clearly indicates the ability to bind KDH is crucial for the function of GarA.

The essentiality of GarA in *M. tuberculosis* points to vulnerability in this pathway that could potentially be exploited for anti-tuberculosis drug development. Indeed, inhibition of another enzyme involved in nitrogen acquisition and glutamine synthesis, glutamine synthetase, prevents growth *in vitro*, in macrophages and in animals (Harth and Horwitz, 1999; 2003). Unfortunately the high frequency of generation of resistant mutants by upregulation of glutamine synthetase (Carroll *et al.*, 2011) makes

this a problematic target for drug development but alternative steps on this pathway may prove to be more tractable targets.

The mechanism of action of GarA, namely direct binding to activate or inhibit multiple enzyme targets with PknG providing an 'off' switch, is unusual and unprecedented. Furthermore the multi-specificity of the binding site on the FHA domain of GarA is also unusual as it binds at least five different proteins: PknG and other kinases via phosphorylated threonine (Villarino *et al.*, 2005) plus three enzyme targets via phosphorylation-independent interaction. Despite the lack of precedent, the physiological relevance of this regulatory pathway is clearly demonstrated here. This particular system is specific to the Actinobacteria, but other FHA domain proteins and serine threonine protein kinases are widespread in prokaryotes and the functions of most are still unknown.

Experimental procedures

Bacterial strains, media, and culture

Mycobacterium smegmatis mc²155 and *M. tuberculosis* H37Rv were routinely cultured in Middlebrook 7H9 medium (Oxoid) supplemented with 10% ADN (0.5% bovine serum albumin, 0.2% dextrose, 0.085% NaCl), 0.05% w/v Tween-80 or Middlebrook 7H10 agar with 10% ADN. A list of strains used in this study is provided in Table S2. To analyse nutrient utilization, a minimal version of Sauton's medium was prepared [3.7 mM KH₂PO₄, 2 mM MgSO₄, 9.5 mM sodium citrate, 0.17 μ M ferric ammonium citrate, pH 7.0 (Lyon *et al.*, 1974)], to which carbon and nitrogen sources were added: glycerol or glucose at 1% v/v or sodium acetate, sodium propionate or sodium succinate at 10 mM, ammonium chloride at 10 mM or asparagine, sodium aspartate, sodium glutamate or glutamine at 30 mM. To disperse the culture surfactants were added at 0.05% w/v: either Tween-80, which can be utilized as a carbon source, or tyloxapol, which cannot. When required antibiotics were used at the following concentrations: kanamycin (50 μ g ml⁻¹) and hygromycin (100 μ g ml⁻¹). Bacterial viability was estimated by measuring colony-forming units (cfu) per ml by plating aliquots of bacterial suspension on Middlebrook 7H10 agar plates containing 10% ADN.

Construction and characterization of the *M. smegmatis* *garA* mutant

An unmarked *garA* deletion mutant was constructed according to a published method (Parish and Stoker, 2000). Briefly, two ~ 1.5 kb fragments containing the downstream and the upstream regions of *garA* were amplified from genomic DNA of *M. smegmatis* mc²155 with primers DF-GarAMS-F/DF-GarAMS-R and UF-GarAMS-F/UF-GarAMS-R (Table S3). Each fragment was cloned into pGEM-T Easy (Promega) and confirmed by sequencing. Fragments were cut out through introduced restriction sites *Hind*III and *Scal* and jointly cloned into the *Hind*III site in p2NIL. The marker cassette from

pGOAL17 containing the *lacZ* alpha gene was inserted into the *PacI* site of the new designed plasmid to construct the suicide vector pMSBR1. Electroporated *M. smegmatis* were plated on Middlebrook 7H10 containing kanamycin, 5-bromo-4-chloro-3-indolyl- β -D-galactopyranoside (Xgal; 80 $\mu\text{g ml}^{-1}$). A single cross-over mutant (verified by PCR) was used to inoculate 5 ml Middlebrook 7H9 medium without kanamycin and cultured to stationary phase. This culture was plated on Middlebrook 7H10 without antibiotics but with Xgal and sucrose (2%) to identify putative unmarked gene deletion mutants as white colonies. The same method was employed to attempt to delete *garA* in *M. tuberculosis* H37Rv.

Complementation vectors were constructed by inserting hexahistidine-tagged *garA* into the integrative vector pRBex-int [kindly provided by R. Brosch, derived from pYUB412 (Bange *et al.*, 1999)]. Primer details are provided as supplementary information. Where required, the sequence of *garA* was altered by site-directed mutagenesis.

Measurement of growth rate and nutrient requirements of *M. smegmatis*

The growth of *M. smegmatis* was measured by monitoring optical density of cultures grown in microplates at 37°C with shaking. The inoculum used was a late-exponential phase culture (OD₆₀₀ 0.5–1.0) in Middlebrook 7H9 medium, which was dispersed by passing through a needle and then diluted in the required medium to an initial optical density of 0.01. Growth curves used at least five wells per strain and were performed in triplicate. Figures show the mean and standard deviation for a representative experiment. The base medium used to investigate carbon utilization contained ammonium chloride 10 mM as the nitrogen source and tyloxapol 0.05% as the surfactant. The base medium used to investigate nitrogen utilization contained 1% glycerol as the carbon source and Tween-80 0.05% as the surfactant. To test the effects of supplementation a basal medium was used containing 1% glucose as the carbon source, ammonium chloride as the nitrogen source and tyloxapol as the surfactant. Growth rates were calculated from the time of most rapid growth, using data from at least 10 h.

Disruption of *garA* in *M. tuberculosis* H37Rv to create conditional mutant *cΔgarA_{Mtb}*

A conditional *garA* knockdown strain, *cΔgarA_{Mtb}*, was constructed. A copy of *garA* under *Pptr* transcriptional control was integrated at the L5 *att* site (Boldrin *et al.*, 2010). The endogenous *garA* was deleted by the pNIL/pGOAL strategy (Parish and Stoker, 2000), and deletion confirmed by PCR. The remaining *garA* gene was controlled by the TetR/Pip OFF system (Boldrin *et al.*, 2010). ATc represses transcription.

Determination of *garA* essentiality in *M. tuberculosis*

The conditional mutant *cΔgarA_{Mtb}* was cultured in Middlebrook 7H9 ADN. To determine whether *garA* is essential, parallel cultures were cultured with zero or 500 ng ml⁻¹ ATc. The initial OD₅₄₀ was 0.06 and cultures were passaged by

dilution to OD₅₄₀ of 0.06 in fresh medium every 48 h. After two passages the difference between cultures with and without ATc became apparent and growth was measured without further dilution. Growth and viability were measured by optical density and by plating on Middlebrook 7H10 ADN to determine cfu ml⁻¹.

'Metabolic complementation' of *cΔgarA_{Mtb}*

cΔgarA_{Mtb} was grown in Middlebrook 7H9 ADN without ATc until the optical density reached 0.6. The culture was then diluted and plated on Middlebrook 7H10 ADN supplemented with the indicated metabolite at 10 mM. Plates were incubated at 37°C and images taken after 3 weeks.

Infection of *cΔgarA_{Mtb}* in THP-1 cells

THP-1 human cell line was grown at 37°C in a 5% CO₂ atmosphere and maintained in RPMI medium (Gibco) supplemented with 10% fetal bovine serum (Gibco). After expansion, THP-1 cells were differentiated into macrophages and infected with *M. tuberculosis* in 96-well plates with a multiplicity of infection of 1:20 cfu per macrophage as previously described (Manganelli *et al.*, 2001). After 90 min of incubation at 37°C, the medium was removed, and cells were washed twice with 100 μl of warm phosphate buffered saline to remove extracellular bacteria. Finally, 100 μl of warm RPMI with or without ATc (500 ng ml⁻¹), was added to each well and the plate was incubated at 37°C. RPMI with or without ATc was replaced every 48 h. For 8 days, every 24 h, starting from 90 min after the initial washes, the medium was removed from three wells, and then intracellular bacteria were released by lysing the macrophages with 100 μl of 0.05% SDS. The suspensions obtained from the lysed macrophages were immediately diluted in 7H9 and plated to determine viable counts. About 95% of macrophages remained viable during the entire experiment, as determined by Trypan blue exclusion.

Acknowledgements

We are grateful to Mary Jackson and Nadine Honoré (Institut Pasteur) for their initial work towards constructing a *garA* deletion mutant in *M. smegmatis*, and to Ida Rosenkrands for anti-GarA serum. This work was funded by the BBSRC (BB/H007865/10) and the European Commission (NM4TB 230874 and MM4TB 260872).

References

- Argyrou, A., and Blanchard, J.S. (2001) *Mycobacterium tuberculosis* lipoamide dehydrogenase is encoded by *Rv0462* and not by the *lpdA* or *lpdB* genes. *Biochemistry* **40**: 11353–11363.
- Bange, F.C., Collins, F.M., and Jacobs, W.R., Jr (1999) Survival of mice infected with *Mycobacterium smegmatis* containing large DNA fragments from *Mycobacterium tuberculosis*. *Tuber Lung Dis* **79**: 171–180.
- Barthe, P., Roumestand, C., Canova, M.J., Kremer, L.,

- Hurard, C., Molle, V., and Cohen-Gonsaud, M. (2009) Dynamic and structural characterization of a bacterial FHA protein reveals a new autoinhibition mechanism. *Structure* **17**: 568–578.
- Belanger, A.E., and Hatfull, G.F. (1999) Exponential-phase glycogen recycling is essential for growth of *Mycobacterium smegmatis*. *J Bacteriol* **181**: 6670–6678.
- Beste, D.J., Hooper, T., Stewart, G., Bonde, B., Avignone-Rossa, C., Bushell, M.E., *et al.* (2007) GSMN-TB: a web-based genome-scale network model of *Mycobacterium tuberculosis* metabolism. *Genome Biol* **8**: R89.
- Boldrin, F., Casonato, S., Dainese, E., Sala, C., Dhar, N., Palu, G., *et al.* (2010) Development of a repressible mycobacterial promoter system based on two transcriptional repressors. *Nucleic Acids Res* **38**: e134.
- Bunik, V.I., and Fernie, A.R. (2009) Metabolic control exerted by the 2-oxoglutarate dehydrogenase reaction: a cross-kingdom comparison of the crossroad between energy production and nitrogen assimilation. *Biochem J* **422**: 405–421.
- Burkovski, A. (2007) Nitrogen control in *Corynebacterium glutamicum*: proteins, mechanisms, signals. *J Microbiol Biotechnol* **17**: 187–194.
- Carroll, P., Waddell, S.J., Butcher, P.D., and Parish, T. (2011) Methionine sulfoximine resistance in *Mycobacterium tuberculosis* is due to a single nucleotide deletion resulting in increased expression of the major glutamine synthetase, GlnA1. *Microb Drug Resist* **17**: 351–355.
- Cowley, S., Ko, M., Pick, N., Chow, R., Downing, K.J., Gordhan, B.G., *et al.* (2004) The *Mycobacterium tuberculosis* protein serine/threonine kinase PknG is linked to cellular glutamate/glutamine levels and is important for growth *in vivo*. *Mol Microbiol* **52**: 1691–1702.
- Durocher, D., Henckel, J., Fersht, A.R., and Jackson, S.P. (1999) The FHA domain is a modular phosphopeptide recognition motif. *Mol Cell* **4**: 387–394.
- England, P., Wehenkel, A., Martins, S., Hoos, S., Andre-Leroux, G., Villarino, A., and Alzari, P.M. (2009) The FHA-containing protein GarA acts as a phosphorylation-dependent molecular switch in mycobacterial signaling. *FEBS Lett* **583**: 301–307.
- Gould, T.A., van de Langemheen, H., Munoz-Elias, E.J., McKinney, J.D., and Sacchettini, J.C. (2006) Dual role of isocitrate lyase 1 in the glyoxylate and methylcitrate cycles in *Mycobacterium tuberculosis*. *Mol Microbiol* **61**: 940–947.
- Griffin, J.E., Gawronski, J.D., Dejesus, M.A., Ioerger, T.R., Akerley, B.J., and Sasseti, C.M. (2011) High-resolution phenotypic profiling defines genes essential for mycobacterial growth and cholesterol catabolism. *PLoS Pathog* **7**: e1002251.
- Gunka, K., and Commichau, F.M. (2012) Control of glutamate homeostasis in *Bacillus subtilis*: a complex interplay between ammonium assimilation, glutamate biosynthesis and degradation. *Mol Microbiol* **85**: 213–224.
- Harth, G., and Horwitz, M.A. (1999) An inhibitor of exported *Mycobacterium tuberculosis* glutamine synthetase selectively blocks the growth of pathogenic mycobacteria in axenic culture and in human monocytes: extracellular proteins as potential novel drug targets. *J Exp Med* **189**: 1425–1436.
- Harth, G., and Horwitz, M.A. (2003) Inhibition of *Mycobacterium tuberculosis* glutamine synthetase as a novel anti-biotic strategy against tuberculosis: demonstration of efficacy *in vivo*. *Infect Immun* **71**: 456–464.
- Jenkins, V.A., Barton, G.R., Robertson, B.D., and Williams, K.J. (2013) Genome wide analysis of the complete GlnR nitrogen-response regulon in *Mycobacterium smegmatis*. *BMC Genomics* **14**: 301.
- Lee, W., Vanderven, B.C., Fahey, R.J., and Russell, D.G. (2013) Intracellular *Mycobacterium tuberculosis* exploits host-derived fatty acids to limit metabolic stress. *J Biol Chem* **288**: 6788–6800.
- Lyon, R.H., Hall, W.H., and Costas-Martinez, C. (1974) Effect of L-asparagine on growth of *Mycobacterium tuberculosis* and on utilization of other amino acids. *J Bacteriol* **117**: 151–156.
- McKinney, J.D., Honer zu Bentrup, K., Munoz-Elias, E.J., Miczak, A., Chen, B., Chan, W.T., *et al.* (2000) Persistence of *Mycobacterium tuberculosis* in macrophages and mice requires the glyoxylate shunt enzyme isocitrate lyase. *Nature* **406**: 735–738.
- Manganelli, R., Voskuil, M.I., Schoolnik, G.K., and Smith, I. (2001) The *Mycobacterium tuberculosis* ECF sigma factor SigE: role in global gene expression and survival in macrophages. *Mol Microbiol* **41**: 423–437.
- Marrero, J., Rhee, K.Y., Schnappinger, D., Pethe, K., and Ehrh, S. (2010) Gluconeogenic carbon flow of tricarboxylic acid cycle intermediates is critical for *Mycobacterium tuberculosis* to establish and maintain infection. *Proc Natl Acad Sci USA* **107**: 9819–9824.
- Middlebrook, G., Cohn, M.L., and Schaefer, W.B. (1954) Studies on isoniazid and tubercle bacilli. III. The isolation, drug-susceptibility, and catalase-testing of tubercle bacilli from isoniazid-treated patients. *Am Rev Tuberc* **70**: 852–872.
- Munoz-Elias, E.J., Upton, A.M., Cherian, J., and McKinney, J.D. (2006) Role of the methylcitrate cycle in *Mycobacterium tuberculosis* metabolism, intracellular growth, and virulence. *Mol Microbiol* **60**: 1109–1122.
- Niebisch, A., Kabus, A., Schultz, C., Weil, B., and Bott, M. (2006) Corynebacterial protein kinase G controls 2-oxoglutarate dehydrogenase activity via the phosphorylation status of the Odh1 protein. *J Biol Chem* **281**: 12300–12307.
- Nott, T.J., Kelly, G., Stach, L., Li, J., Westcott, S., Patel, D., *et al.* (2009) An intramolecular switch regulates phospho-independent FHA domain interactions in *Mycobacterium tuberculosis*. *Sci Signal* **2**: ra12.
- O'Hare, H.M., Duran, R., Cervenansky, C., Bellinzoni, M., Wehenkel, A.M., Pritsch, O., *et al.* (2008) Regulation of glutamate metabolism by protein kinases in mycobacteria. *Mol Microbiol* **70**: 1408–1423.
- Parish, T., and Stoker, N.G. (2000) Use of a flexible cassette method to generate a double unmarked *Mycobacterium tuberculosis* tlyA plcABC mutant by gene replacement. *Micobiology* **146** (Part 8): 1969–1975.
- Reuther, J., and Wohlleben, W. (2007) Nitrogen metabolism in *Streptomyces coelicolor*: transcriptional and post-translational regulation. *J Mol Microbiol Biotechnol* **12**: 139–146.
- Sasseti, C.M., Boyd, D.H., and Rubin, E.J. (2003) Genes required for mycobacterial growth defined by high density mutagenesis. *Mol Microbiol* **48**: 77–84.

- Tian, J., Bryk, R., Shi, S., Erdjument-Bromage, H., Tempst, P., and Nathan, C. (2005) *Mycobacterium tuberculosis* appears to lack alpha-ketoglutarate dehydrogenase and encodes pyruvate dehydrogenase in widely separated genes. *Mol Microbiol* **57**: 859–868.
- Tullius, M.V., Harth, G., and Horwitz, M.A. (2003) Glutamine synthetase GlnA1 is essential for growth of *Mycobacterium tuberculosis* in human THP-1 macrophages and guinea pigs. *Infect Immun* **71**: 3927–3936.
- Upton, A.M., and McKinney, J.D. (2007) Role of the methylcitrate cycle in propionate metabolism and detoxification in *Mycobacterium smegmatis*. *Microbiology* **153**: 3973–3982.
- Villarino, A., Duran, R., Wehenkel, A., Fernandez, P., England, P., Brodin, P., *et al.* (2005) Proteomic identification of *M. tuberculosis* protein kinase substrates: PknB recruits GarA, a FHA domain-containing protein, through activation loop-mediated interactions. *J Mol Biol* **350**: 953–963.
- Wagner, T., Bellinzoni, M., Wehenkel, A., O'Hare, H.M., and Alzari, P.M. (2011) Functional plasticity and allosteric regulation of alpha-ketoglutarate decarboxylase in central mycobacterial metabolism. *Chem Biol* **18**: 1011–1020.

Supporting information

Additional supporting information may be found in the online version of this article at the publisher's web-site.